

THE HARD RESET
A TERRORGRAM PRODUCTION



A TERRORGRAM PUBLICATION



THE BOOK WRITTEN BY ONE HUNDRED AUTHORS
MAY OUR EXPERIENCES AND IDEAS SHAPE YOU



"The one means that wins the easiest victory over reason is terror and force."

— ADOLF HITLER

THE HARD RESET TABLE OF CONTENTS I

PASSAGE	AUTHOR	PAGE
DECLARATION I BEGINS - - - - -	XXXXX	7
INTRODUCTION - - - - -	YANKEE	8
HISTORY - - - - -	ZULU	9
PERSONAL SPACE - - - - -	MIKE	10
TERRORIST - - - - -	OSCAR	11
COP KILLER - - - - -	GOLF	12-13
WORDS FOR THOSE BEHIND ENEMY LINES - - - - -	HOTEL	14
ATTACK - - - - -	HOTEL	15
A NECKLACE FOR A GOOD ALLY - - - - -	OSCAR	16
THE SYSTEM - - - - -	QUEBEC	17-18
HEX WRENCH POST - - - - -	OSCAR	19
PIGGYBANK - - - - -	WHISKEY	20
CHARLS - - - - -	HOTEL	21
MISCREANT - - - - -	OSCAR	22
A FEAR OF WORTHLESS DEATH - - - - -	BRAVO	23
WARM - - - - -	YANKEE	24
THE DISCOVERY OF C6H6 - - - - -	YANKEE	25
MY BIGGEST WORRY - - - - -	ZULU	26
BECOMING THE ENEMY - - - - -	GOLF	27
XI - - - - -	GOLF	28
100% READY - - - - -	NOVEMBER	29
FUCK ARGUING - - - - -	OSCAR	30
WEED IS FOR NIGGERS - - - - -	HOTEL	31
CALLING THE DEAD BABY STORE - - - - -	OSCAR	32-33
COMPETENCE OF VIOLENCE - - - - -	GOLF	34-35
SHOWERS - - - - -	OSCAR	36
ILLEGAL MATERIAL RAIL RAMP - - - - -	JULIET	37
GUERRILLA - - - - -	HOTEL	38
SHANGHAI'D IN SHROOM CITY - - - - -	OSCAR	39-41
GATES - - - - -	GOLF	42
VICTIMHOOD, COMFORT - - - - -	GOLF	43

"SOCIETY IS ORGANIC. THE SYSTEM IS DEMONIC."

— QUEBEC, PG.18

"TRY NOT TO DIE FROM STUPID STUFF LIKE EATING POISON"

— BRAVO, PG.23

*"HE CHOOSES THE BATTLES, SETS THE TIMES
HE'S YOU AND ME, PLANNING OUR CRIMES"*

— HOTEL, PG.38

THE HARD RESET
TABLE OF CONTENTS II

PASSAGE	AUTHOR	PAGE
FOUR PANEL - - - - -	OSCAR	44
RETURN TO PICT - - - - -	UNIFORM	45
DECLARATION II BEGINS - - - - -	XXXXX	46
P.R.A.Y. - - - - -	NOVEMBER	47-49
MINOR CRIMES - - - - -	OSCAR	50
CAR BOMBS - - - - -	UNIFORM	51
THE JOY OF HARMONY - - - - -	HOTEL	52-53
BOYS DON'T CRY - - - - -	OSCAR	54
POLITICIANS - - - - -	KILO	55
IN MINECRAFT - - - - -	X-RAY	56-57
POWER - - - - -	GOLF	58
MORTARPOSTING - - - - -	HOTEL	59
MEMORIALS ARE OUR MONUMENTS - - - - -	WHISKEY	60-61
AFFIRMATION - - - - -	QUEBEC	62
BATTERY OPERATED - - - - -	GOLF	63
CS GAS - - - - -	OSCAR	64
FUCK COPS - - - - -	HOTEL	65
PATH TO CLOSURE - - - - -	GOLF	66
EMPATHY - - - - -	GOLF	67
ANONYMOUS BOMBER - - - - -	OSCAR	68
CHEMIST - - - - -	GOLF	69
GETTING AWAY WITH IT IS EASY - - - - -	ZULU	73
THE ONLY THING - - - - -	HOTEL	74
UNDERCOVER - - - - -	OSCAR	75
DUMBOCLAPCY - - - - -	GOLF	76
GOD BLESS AMERICA - - - - -	HOTEL	77
COPS - - - - -	OSCAR	78
SYSTEM GUILT - - - - -	GOLF	79
RUIN THE WORLD - - - - -	HOTEL	80
AGAINST THE MODERN WORLD - - - - -	ALPHA	81
NEEDLE IN A HAYSTACK - - - - -	OSCAR	82

*"COMPANIES LIKE MONSANTO, AGRIUM, CHINESE GREEN,
AND EVOGENE ARE PROTIFING POISONERS OF THE LAND."*

— NOVEMBER, PG.49

*"NOT TOO LONG FROM NOW, A BOMB WILL EXPLODE,
AND I'M THE ONLY ONE WHO KNOW ITS TARGET."*

— OSCAR, PG.68

*"YOU'RE TELLING ME I'M GUILTY OF A HATE CRIME?
STRANGE, I DON'T FEEL GUILTY."*

— GOLF, PG.79

THE HARD RESET
TABLE OF CONTENTS III

PASSAGE	AUTHOR	PAGE
LAST MAN STANDING - - - - -	OSCAR	83
THE LAST THING - - - - -	ROMEO	84
DECLARATION III BEGINS - - - - -	XXXXX	85
MARKED FOR DESTRUCTION - - - - -	OSCAR	86-87
JUST TRY AND STOP US - - - - -	HOTEL	88
INFRASTRUCTURE NIGGAS - - - - -	GOLF	89-118
3 MISSED MEALS - - - - -	OSCAR	119
THIS BOOK IS FOR REFERENCE ONLY - - - - -	HOTEL	120
FOUR-GW - - - - -	HOTEL	121
DECLARATION IV BEGINS - - - - -	XXXXX	122
SUGONDESE PEOPLE'S LIBERATION FRONT - - - - -	OSCAR	123-124
A VERY PARTICULAR SET OF SKILLS - - - - -	MIKE	125-129
THIS MY PARTY BRUH WE NEVER GETTING HEALTHCARE - - - - -	OSCAR	130
BLEED THE BEAST - - - - -	KILO	130
BUGCHASING - - - - -	ZULU	130
LOW STAKES - - - - -	OSCAR	131
CRUELTY-FREE CANNIBALISM - - - - -	OSCAR	132
THE FIRST SHOT - - - - -	PAPA	133
LEGALIZE JOKES - - - - -	OSCAR	134
SHUT THEM IN - - - - -	OSCAR	135
DISCOUNT SMELLS - - - - -	INDIA	135
VISITING THE CITY - - - - -	TANGO	136-137
THE SUN - - - - -	GOLF	138
NATURAL ORDER - - - - -	OSCAR	139-140
WATER, THE GREAT GRANDFATHER OF ALL - - - - -	GOLF	141
FUMIGATE THE CITIES - - - - -	WHISKEY	142-143
WEED'S PURPOSE IS TO LIMIT YOU - - - - -	BRAVO	144
PUBLIC BOOT, PRIVATE BOOT - - - - -	OSCAR	145
YOU WILL NEVER BE A WOMAN - - - - -	OSCAR	145
A CHALLENGER APPEARS - - - - -	OSCAR	145
MESSAGE FOR THE BROKEN - - - - -	OSCAR	146

*"THEY WANT US TO WASTE AWAY,
NOT TO MAKE OUR HEROIC FINAL STAND."*

— OSCAR, PG.87

*"WHO I AM
A SABOTEUR"*

— GOLF, PG.118

"FAGS GET SMOKED"

— OSCAR, PG.120

PASSAGE	AUTHOR	PAGE
MAGAWAFFEN MKULTRA ACTIVATION TUTORIAL	OSCAR	147-148
ROASTING KEBAB	VICTOR	149
JACK LETTS	GOLF	150
HARD TRAINING	HOTEL	151
ACCELERATED TRAINING	HOTEL	152
DROP THE WEIGHT OF THE WORLD	GOLF	153
MORE OR LESS	GOLF	154-155
IMMORTALITY	OSCAR	156
HOLY LEAGUE OF CATHOLIC LIFTER-SHITPOSTERS	OSCAR	157
WHITE TERROR NIRVANA	WHISKEY	158
RELIGION, JEWISH LENS	GOLF	159
WILL TO POWER	HOTEL	160
EXTERMINATOR	ZULU	161
THE AWD MORAL CODE	NOVEMBER	162-165
YOU ARE A DIAMOND IN THE ROUGH	KILO	166
XENOPHOBIA	OSCAR	167
NATIONALISM	OSCAR	168
ANALYZING THE DIARIES	LIMA	169-174
2041: A SPACE ODYSSEY	OSCAR	175-176
DECLARATION V BEGINS	XXXXX	177
HIVEMIND	OSCAR	178
MORNING	FOXTROT	178
POETRY	KILO	179
NATURAL BEAUTY	GOLF	180-181
THE TRUTH WILL SET YOU FREE	UNIFORM	182-184
CARAVAN	DELTA	185
NEXT OF KIN	YANKEE	186
HOMESICK FOR A PLACE I'M NOT EVEN SURE EXISTS	OSCAR	187-188
A POLITICAL STATEMENT	OSCAR	189
INFANTICIDE	OSCAR	190
ABORTIONISTS	OSCAR	191

*"IF YOU CAN'T BYPASS COUPLE OF CAMERAS IN CITY
WITH MILLIONS OF OCCUPANTS - DIRECT ACTION IS
JUST NOT MEANT FOR YOU."*

— VICTOR, PG.149

"WAKE THE FUCK UP READY TO ANNIHILATE ISRAEL"

— OSCAR, PG.157

*"LIBERALS ARE MORE FANATICAL THAN CONSERVATIVES,
AND BECAUSE OF THIS, CONSERVATIVISM HAS BEEN A LOSING
BATTLE FOR A CENTURY."*

— HOTEL, PG.160

**THE HARD RESET
TABLE OF CONTENTS V**

PASSAGE	AUTHOR	PAGE
FORCING ACCOUNTABILITY - - - - -	WHISKEY	192-193
KEEP THE ROT SAVE THE TOOLS - - - - -	YANKEE	194
WASH YOUR HANDS OF THIS FILTH - - - - -	TANGO	195
BLUNT ROTATION - - - - -	ZULU	196
WE'RE IN THIS TOGETHER - - - - -	WHISKEY	197
RACE TRAITOR - - - - -	OSCAR	198
UNRELATED POSTS - - - - -	HOTEL	199
MAKE. EVERY. SHOT. COUNT. - - - - -	WHISKEY	200
MUTUAL COMBAT - - - - -	WHIKSEY	201
CHURCHGOERS - - - - -	MIKE	202
TWO BIRDS WITH ONE STONE - - - - -	TANGO	203
PULL THE FIRE ALARM - - - - -	GOLF	204
COUP DE GRACE - - - - -	MIKE	205-206
THE ACCELERATIONIST THREAT - - - - -	WHISKEY	207
DRY RUN - - - - -	MIKE	208
NO REGRETS - - - - -	WHISKEY	209
INTERROGATION TACTICS - - - - -	ZULU	210
VICTORY TO THE KLAN - - - - -	HOTEL	211-212
COLONIES - - - - -	OSCAR	213
GOYFEED - - - - -	OSCAR	213
SOY - - - - -	ZULU	214
THERE IS A WIGNAT AMONG US - - - - -	OSCAR	215
THE SHOAH GOY - - - - -	SIERRA	216
THAT HINDU KUSH HIT DIFFERENT - - - - -	OSCAR	217-218
ON THE OTHER SIDE - - - - -	YANKEE	219-220
FUCK INDIANS - - - - -	QUEBEC	221
FUCK BANKS - - - - -	HOTEL	222
TREAD - - - - -	OSCAR	223
A TASTE OF TERROR - - - - -	GOLF	224
HOW SMART ARE YOU TO REGRESS UNFULFILLED? - - - - -	YANKEE	225
PAX PROSPERITY - - - - -	YANKEE	226

*"IF MATEEN CAN KILL FIFTY,
IMAGINE WHAT YOU CAN DO."*

— WHISKEY, PG.193

*"FOR EVERY ACCELERATIONIST WITH AN INTERNET PRESENCE,
THERE ARE 1000 MORE SHROUDED IN UNTRACEABLE ANONYMITY."*

— WHISKEY, PG.207

"THERE IS A WIGNAT AMONG US"

— OSCAR, PG.215

PASSAGE	AUTHOR	PAGE
IMAGINE - - - - -	KILO	227
THE ETERNAL VILLAGER - - - - -	OSCAR	228
FORCE - - - - -	OSCAR	229
NOLA - - - - -	OSCAR	230
DEMOCRATIC SOLUTIONS - - - - -	OSCAR	231
DEPORTATION - - - - -	OSCAR	232
NOT OF THIS WORLD - - - - -	OSCAR	233
COULDN'T BE ME - - - - -	OSCAR	234
YOU GOOD? YOU GOOD? - - - - -	HOTEL	235
JOGGERPOST - - - - -	OSCAR	236-237
DECLARATION VI BEGINS - - - - -	XXXXX	238
REAL CHANGE - - - - -	ROMEO	239
BORDER CRISIS - - - - -	WHISKEY	244
AAAAAAAAAAAAAAAAAAAAA - - - - -	GOLF	245
KALOKAGATHIA - - - - -	HOTEL	246
A LETTER TO THE NEXT DISCIPLES - - - - -	JULIET	247
OPTICS - - - - -	GOLF	248
CONSIDERATIONS OF OUR STRUGGLE - - - - -	BRAVO	249-250
AN UNCOMMON AESTHETIC - - - - -	PAPA	251
A NOTE TO THE PROSPECTIVE LEADERS OF TOMORROW - - - - -	HOTEL	252
THEIR LATE GAME - - - - -	ECHO	253
DECLARATION VII BEGINS, THE FINAL DECLARATION - - - - -	XXXXX	254
I WILL RETURN - - - - -	CHARLIE	255
WHAT IS TO COME - - - - -	NOVEMBER	256
XXXXX - - - - -	XXXXX	257
XXXXX - - - - -	XXXXX	258

*"THE IDEAS IN THIS BOOK ARE MORE THAN JUSTIFIED CONSIDERING
WHAT THE ENEMY HAS ALREADY DONE TO OUR PEOPLE"*

— GOLF, PG.245

"IF YOU'RE STILL FAT OR GREASY THEN THAT'S GONNA BE A HUGE PROBLEM."

— GOLF, PG.248

*"PEOPLE HAVE TO ANESTHETIZE THEMSELVES FROM HOW
UGLY AND SPIRITUALLY EMPTY THEIR WORLD IS."*

— ECHO, PG.253

**THE FOLLOWING BOOK IS DIVIDED IN TO 7 "DECLARATIONS".
THE READER IS ADVISED TO READ THE BOOK ONE DECLARATION AT A TIME.**

DECLARATION I

YOU BEGIN UP THROUGH A PATH;
UNWELCOMING GEOGRAPHY IS STARING AT YOU IN THE DISTANCE

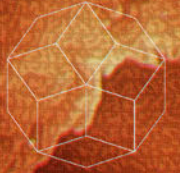

I
PRESENT
I

007-045

II
FUTURE
II

046-084

III
IMPERFECT
III

085-121

122-176

IV
PERFECT
IV

177-237 FUTURE PERFECT

V
V

238-253

VI
PLUPERFECT
VI

HARD RESET

DECLARATION I INFORMATION

BRAVO - 1 PASSAGE
GOLF - 6 PASSAGES
HOTEL - 5 PASSAGES
JULIET - 1 PASSAGE
MIKE - 1 PASSAGE
NOVEMBER - 1 PASSAGE
OSCAR - 9 PASSAGES
QUEBEC - 1 PASSAGE
UNIFORM - 1 PASSAGE
WHISKEY - 1 PASSAGE
YANKEE - 3 PASSAGES
ZULU - 2 PASSAGES
TOTAL - 32 PASSAGES
39 PAGES

007 046 085 122 177 238

INTRODUCTION

YANKEE

Dear reader,

Regardless of your personal feelings on the matter, a great collapse is coming. Some would say it's already here. A great restructuring will surely come on its heels.

The elites have their own vision for the future – eat the bugs, drink the soy, live in the pod, consume product, get excited for next product. The Great Reset is what they call it – an integration of all of the System's parts, all converging on top of your head. The masses will follow the path of least resistance, the rest will get crushed... or so their plan goes.

We have a vision of our own. Saboteur attacks on infrastructure crippling the System's ability to enforce its rules. Starvation and mayhem in the cities. Gas stations turning into fortified bandit encampments surrounded by heads on spikes as a warning against those who might be tempted to storm them and take the precious fuel for themselves. The state military trying to squash one insurgency, only to get ambushed by a different insurgency, leaving invaluable equipment behind for the militants to enrich themselves with.

Desperate people using weapons and ammunition to get food and water – some of them bartering, most of them looting or shooting. Politicians fucking off to their underground bunkers, hoping their supplies will see them through to the end. They won't, because there's no end, only the beginning of a new era.

This is the Hard Reset. This is the only way forward for our people. There's no turning back now.

***History will assume
you loved Harry
Potter and allowed
women to do butt
stuff to you unless you
break enough laws to
become a folk hero.***



PERSONAL SPACE

THE HARD RESET

AUTHOR: MIKE

PREPARING FOR YOUR BIG DAY? GET YOUR OWN PLACE.

I CANNOT STRESS THIS ENOUGH.

YOU DON'T NECESSARILY NEED TO GO ALL-OUT AND RENT A FARM LIKE BREIVIK DID. YOU DON'T NEED TO MOVE TO ANOTHER COUNTRY LIKE TARRANT DID. BUT AT A MINIMUM, YOU NEED YOUR OWN APARTMENT (NO ROOMMATES) FOR A COUPLE MONTHS, FAR ENOUGH FROM FRIENDS AND FAMILY THAT THEY WON'T SHOW UP UNINVITED.

ONCE YOU MOVE, YOU CAN BEGIN GRADUALLY DE-SOCIALIZING FROM THOSE CLOSE TO YOU. DON'T CUT OFF ALL CONTACT IMMEDIATELY - CONCERNED OR SUSPICIOUS LOVED ONES CAN JEOPARDIZE YOUR OPERATION FROM AFAR. ACT NATURAL, SAY YOU'VE BEEN "SUPER BUSY" WITH WORK OR SCHOOL. KEEP IN TOUCH, BUT KEEP IRL VISITS ELSEWHERE. IF THEY INSIST ON THROWING YOU A HOUSEWARMING PARTY, THAT SHOULD BE THE FIRST AND LAST TIME THEY STEP FOOT IN YOUR NEW PLACE.

YES, RENTAL COSTS ARE SKYROCKETING AND ALREADY OUT OF REACH FOR MANY, BUT FIND A WAY TO MAKE IT WORK. TAKE A SECOND JOB. PICK UP A SIDE HUSTLE OR TWO IN YOUR SPARE TIME. SELL YOUR POSSESSIONS. TAKE OUT PERSONAL LOANS. OPEN AS MANY CREDIT CARDS AS YOU POSSIBLY CAN AND MAX THEM OUT. IT DOESN'T REALLY MATTER - IT'S ONLY FOR A COUPLE MONTHS. AND BESIDES, YOUR DEBTS WON'T MATTER AFTER YOUR BIG DAY. IN FACT, NOTHING WILL MATTER, SO DON'T CUT CORNERS WITH OPERATIONAL EXPENSES. CONSIDER A FEW MONTHS' RENT ONE OF THOSE (NON-NEGOTIABLE!!!) EXPENSES.

LIVING ALONE MIGHT BE EXPENSIVE, BUT THE FREEDOM TO PREPARE FOR AND ULTIMATELY SUCCEED IN YOUR ATTACK ARE PRICELESS.

YOU'RE PAYING FOR AN UNOBSTRUCTED PATH TO VICTORY. YOU'RE PAYING FOR THE FREEDOM TO STOCKPILE WEAPONS, AMMUNITION, ARMOR, PRECURSOR CHEMICALS AND GEAR. YOU'RE PAYING FOR THE PRIVACY YOU NEED TO WRITE YOUR MANIFESTO AND MANUFACTURE EXPLOSIVES. YOU'RE PAYING FOR THE PEACE OF MIND YOU NEED TO BUILD YOUR BOMBS AND MENTALLY READY YOURSELF TO DETONATE THEM. YOU'RE PAYING TO ELIMINATE ALMOST ALL EXTERNAL VARIABLES THAT COULD, WITHOUT WARNING, RUIN YOUR PLANS AND COST YOU EVERYTHING.

10

WHEN THE STAKES ARE THIS HIGH, TRUST NO ONE BUT YOURSELF, AND LEAVE NOTHING TO CHANCE.

TERRORIST OSCAR

The System can't in good faith call all of its enemies' terrorists, so it does it in bad faith.

Men who wouldn't even dream of using violence and intimidation for political purposes are treated worse than the CIA-funded mercenary groups from the desert, specifically, because they're somewhat opposed to the System.

To the System, using violence and intimidation is a routine practice, proceeding from

logically pro- their perceived mo- nopoly on power – a paper tiger, if there ever was one. Its media cries about lack of White men being called terrorists, while the same media calls every White man who stands up for his people a terrorist. All their screeching can ever amount to one thing – emboldening us, strengthening our morale, and fortifying our resolve. If the vilest scum of the earth thinks you're the worst, you must be onto something.



Hard Reset Cop killer

THERE IS A POSSESSIVE COP IN YOUR HEAD AND YOU MUST KILL HIM

Every thought in your head of chaos, and of attack are policed by the cop who lives in your head - he tells you you shouldn't steal from others, or hurt others. He prevents you from acting to your own accord and for your own gain.

The cop in your head is a mental block put in place to stop you from reaching harmony with yourself. You will always be plagued with self doubt while committing to action. After the action, you will live a few days in worry for what you have done. You'll go out a little less, check details of the action you did, and it's outcomes.

The cop drives conformity in to your life. He dictates the way you act outside of your head and often prevents you from living out even the most minor desires you have. He prevents you from gaining honor.

Everyone has this cop in their head, some are not even aware that he has been placed there. They believe their own actions to be appropriate, and justified. They believe that their desire to commit arson or sabotage are antisocial, that these ideas are wrong and they shouldn't do them solely because of the risk.

"Ten years for possession of a prohibited weapon" the pig says, rent free, inside your head as you contemplate buying a 3D printer and some basic hand tools.

"Charges of grand larceny in the third degree, expect seven years" he says when you see enemy property that you should be procuring for your own means - our own means.

"Create violence - hell, create the fear that you may even commit violence and we'll put you in a cage for sixty days" says the jew in blue when you consider fully legitimate violence against the punk nigger who just decided to eliminate any plans you had for a normal day.

Left, right.
Marxist, Fascist.
Pro-police, anti-police.

It doesn't matter who you are. The cop in your head will bring nothing but unsuitable fear and unwarranted anxiety to the minds of those willing to handle things on their own.

Kill the cop in your head. Sing to a tune:
"I will kill the cop in my head. When the cop is dead. I will be free."

THERE IS A DEPRAVED JEW IN YOUR HEAD AND YOU MUST KILL HIM

Thoughts in the heads of our people that aren't ours; maybe in your head. Brought on by your short twenty-one year life, consuming every advertisement, film, and image in front of your eyes. The jew in your head has placed his poisonous hooks in to you.

Unreasonable thoughts of sexual depravity - affecting everyone. Affecting the masses. Everyone you know has desired to rape or be raped at one point or another. The jew has infected the minds of even your own family with unallowable perversion.

The jew in the heads of those without a mental resistance to his contamination, expect them to seek hormone therapy, casual hook up, sex crime, sex change surgery, and orgy within six months of today. Those without the ability to see that the thoughts in their heads are not their own, but are the malignant words of the jew in their head, will only get worse day by day.

Even you, the reader, could have a jew living in your head rent free. Cast his polluted words out of your minds. Seek any virtues that free you from his directed blight.

The jew in your head causes you to seek pointless sexual encounter with people you consider disgusting. The overweight, the blemished, the old, even the non-White are not discounted by those with the jew living in their head.

Kill the jew in your head. Sing to a tune:
"I will kill the jew in my head. The jew is dead. I am free."

Help others kill the jew in their heads after you kill the one in yours.

bruh
Racist
Cop
killer

WORDS
FOR
THOSE
BEHIND
ENEMY
LINES,
FENCED
IN WITH A
FOREIGN
ARMY OF
CREEPING
BROWN
HORDES,
STINKING
OF
MISTRUST



SLINGSHOTS
TO SUICIDE
VESTS

A NAIL
UNDER THE
ENEMY'S TOE

A WRENCH IN
THE GEARS
OF THEIR
MACHINE

*"GOD IS
GREAT!"*, AN
UNWANTED
MANTRA IN
THEIR MINDS.

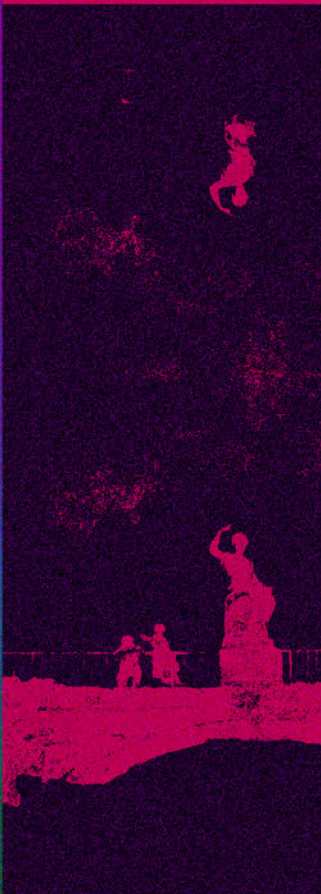

HARD RESET
HARD RESET
HARD RESET
HARD RESET
HARD RESET
HARD RESET



HATE is natural to us



HATE is natural to us

HATE is natural to us



HARD



RESET

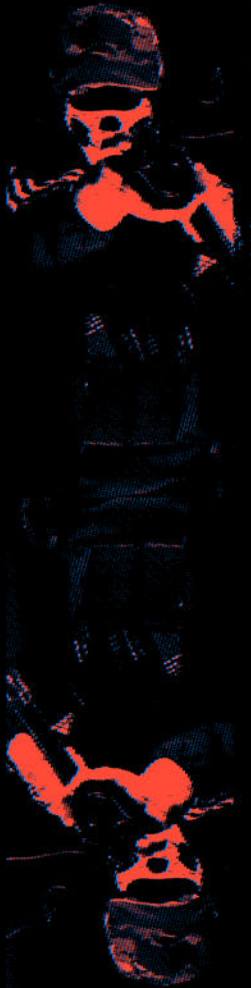

HATE is natural to us



ATTACK IS SOMETHING DONE IN HATE.

**ATTACK, SABOTAGE,
VIOLENCE, AND BRUTALITY
ALL DEFINE ACCELERATION;**

THEY ARE THINGS DONE IN HATE AND THEY WILL EXPOSE AND BURN OUR ENEMIES OUT FAR GREATER THAN MERELY BEING READY AND HOPEFUL FOR COLLAPSE.



HATE is natural to us

A NECKLACE FOR A GOOD ALLY

OSCAR

*Being a good little race
traitor won't save you when
they whip out the truck tires
with the gasoline in them.*

Demonic system



A demon is a supernatural entity, typically associated with evil, prevalent historically in religion, occultism, literature, fiction, mythology, and folklore; as well as in media such as comics, video games, movies, anime, and television series.



SYSTEM

P-17

[The text in this block is heavily distorted and illegible, appearing as a block of yellow and white noise.]



We don't live in a society. We live under the System. Society is you trading homegrown fruits and vegetables with your neighbor. The System is your neighborhood becoming another dumping ground for bulbheads fresh off the boat. Society is you contributing to the common wealth, ensuring your nation prospers. The System is your taxes paying for endless zionist wars. Society is your children being born into a better world than you were. The System is your children being preyed upon by pedophiles in drag queen story hour. Society is organic. The System is demonic.



14/88

HEX WRENCH POST

OSCAR

PAGE 19

My hands sting from handling harsh chemicals all day with inadequate protective gear. I put on cotton gloves to spare the public from seeing the blisters making me look like a stigmatic, even though the real reason is that no material offers great manual dexterity and complete lack of fingerprints at an incredibly low price quite like cotton does. That will come in useful.

The tram is so packed with rabble that I'm having difficulty thinking. Any mind readers present will have a tough time getting information from my face, which is covered by a mask, not for coof reasons, but for anonymity reasons. A faded old work shirt and an even older pair of jeans complete my unassuming exterior and distract from my rather expensive high-quality work boots. Always treat yourself when it comes to those, king. I got mine at a BLM riot last year and they still haven't let me down.

I keep an eye out for onlookers as I inconspicuously begin to unscrew the hex bolts under the seat in front of me. Once enough of them have been removed and the rest sufficiently loosened, the seat will stay in place until the tram has to brake suddenly, in which case the seat will come flying forward, presumably along with its occupant. This will no doubt cause a scene, seeing as modern riot drones are incapable of recognizing cases with no guilty party, which will in turn lead to any potential witnesses who may be susceptible to our worldview getting a hard dose of reality.

Carry a hex wrench, a Sharpie and a knockoff Swiss army knife and be sure to spread a little chaos wherever you go.

THE
**HARD
RESE**



normies collect loose change
in their piggy banks.

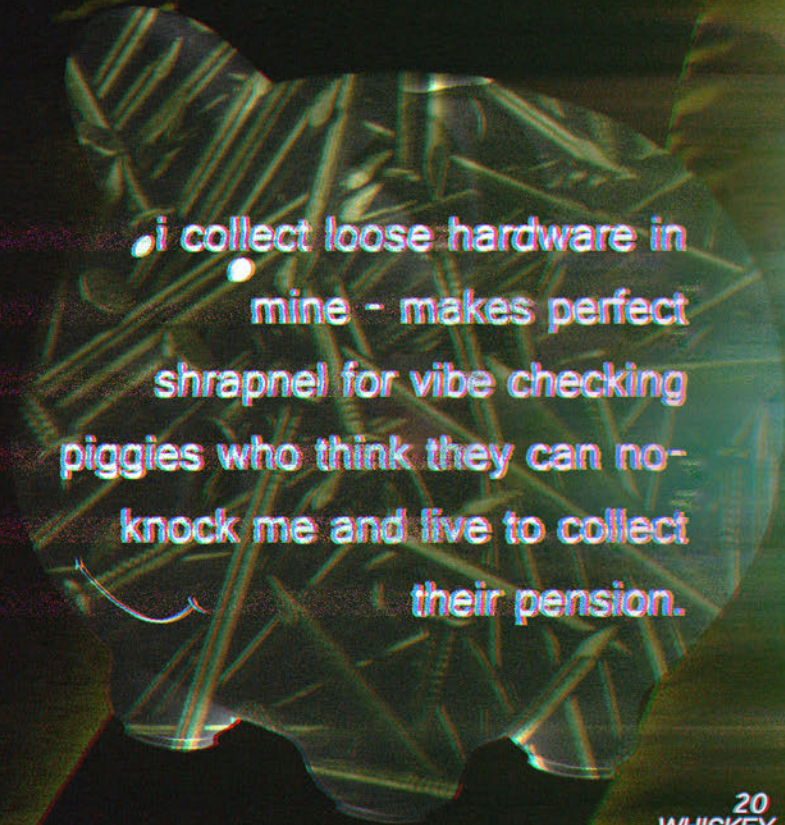

i collect loose hardware in
mine - makes perfect
shrapnel for vibe checking
piggies who think they can no-
knock me and live to collect
their pension.



“Some of these people aren't stupid, they're here to kill you.”



HARD RESET

I tamper with equipment, fix it when asked to, then suggest the company replace it. I do this often enough to cause a dent in the budget, but not often enough to be suspicious. It costs the company time and money that could be spent undermining Our People - a sacrifice I'm willing to make.

I am writing the nigger word in visible places, then anonymously reporting it to local leftoid media, then calling on every local business to implement mandatory anti-racism training sessions. This not only ties up resources and wastes time, it also alienates the White workers from their non-White peers, leading to ethnic tensions that will make more of Our People more likely to adapt Our Worldview.

MISCREANT

A FEAR OF WORTHLESS DEATH

"Live a life worthy of remembrance. To us an accident would be to die in bed."

Do I fear death? It depends on the type of death.

I'm in bed right now, I've been in bed for 3 days. I'm shitting the equivalent of what looks like a specialty Starbucks drink every hour on the hour, my stomach burns in pain, and my headache is only getting worse. My gut flora? Decimated. My immune system is probably more pathetic than a ten year old desperately eating his expired Halloween candy in spring time.

I don't fear death literally, when it happens, I'll literally be back in a bit, reborn, and I probably won't be as fucked up as I am at the moment. I do fear death in a useless way however. A death in bed, basically a suicide without purpose. A waste of man power. A Boston Marathon that never had it's proper ending.

If I died in bed now, surrounded by legitimate targets in the middle of a [major city] I would feel I wasted the last few days of my life.

If I died after a prolonged firefight with zog inside some pornhub studio, synagogue, or california macdonalds then I'd pass on with a smile and no fear of where God/-Truth/The One/The Sun places me next.

I'll fight on to survive now, so my death will actually mean something when the time comes.

Try not to die from stupid stuff like eating poison, or a car crash.

- Me, after eating nearly 300g of that grocery store raw liver and likely riddling my body with disease, parasites, and 1400%+DV intake of vitamin A.

TRIPLE THE HATRED.

QUADRUPLE THE ANGER.

The warm glow of razed cities is what we all really want. Your enemies play dirty whenever they're losing. People who don't inspire mercy don't deserve it. It's impossible to know if you are truly right if you don't stake claim to an era of history. In the end you are either struck down by everything out of your control or you yourself fall to ignorance and arrogance.

We are going to war with the greatest enemy of our lifetimes. This foe is senile and cowardly, hiding away in chambers unseen and unmolested. You are about to starve and fight or conform for the last time. This is the Great Reset or the Great Rebirth. No matter how you look at it the all of this won't last.



**Warm
by Yankee
The Hard Reset
Page 24**

HARD RESET

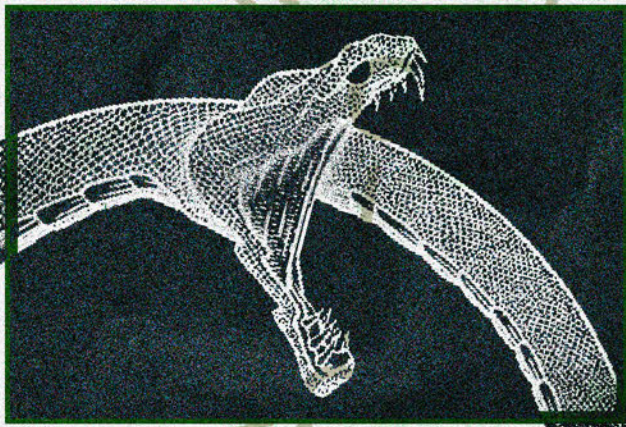

THE DISCOVERY OF C₆H₆

1865, August Kekulé discovers Benzene in which he modeled it after the ouroboros.

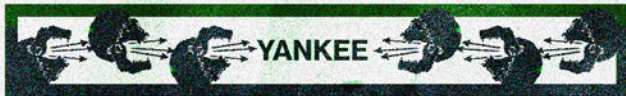

Capitalism

is about squeezing people into putting effort into their work. It's a cycle, people put effort into their work but eventually get bored, apathetic, and angry that they are given little to nothing in return and begin putting in minimum effort until the people in control start squeezing again. Endlessly squeezing people into a corrupt vision of how things should be.

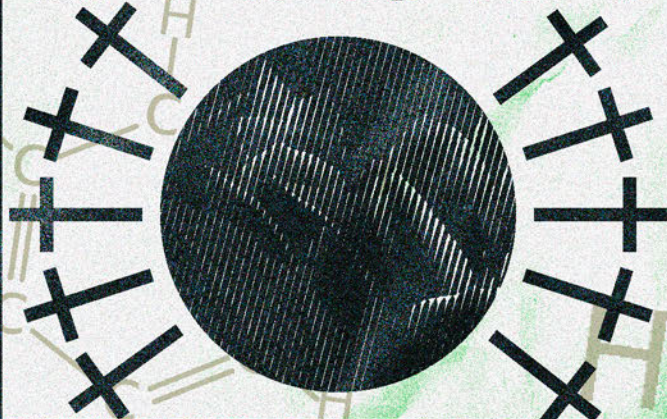
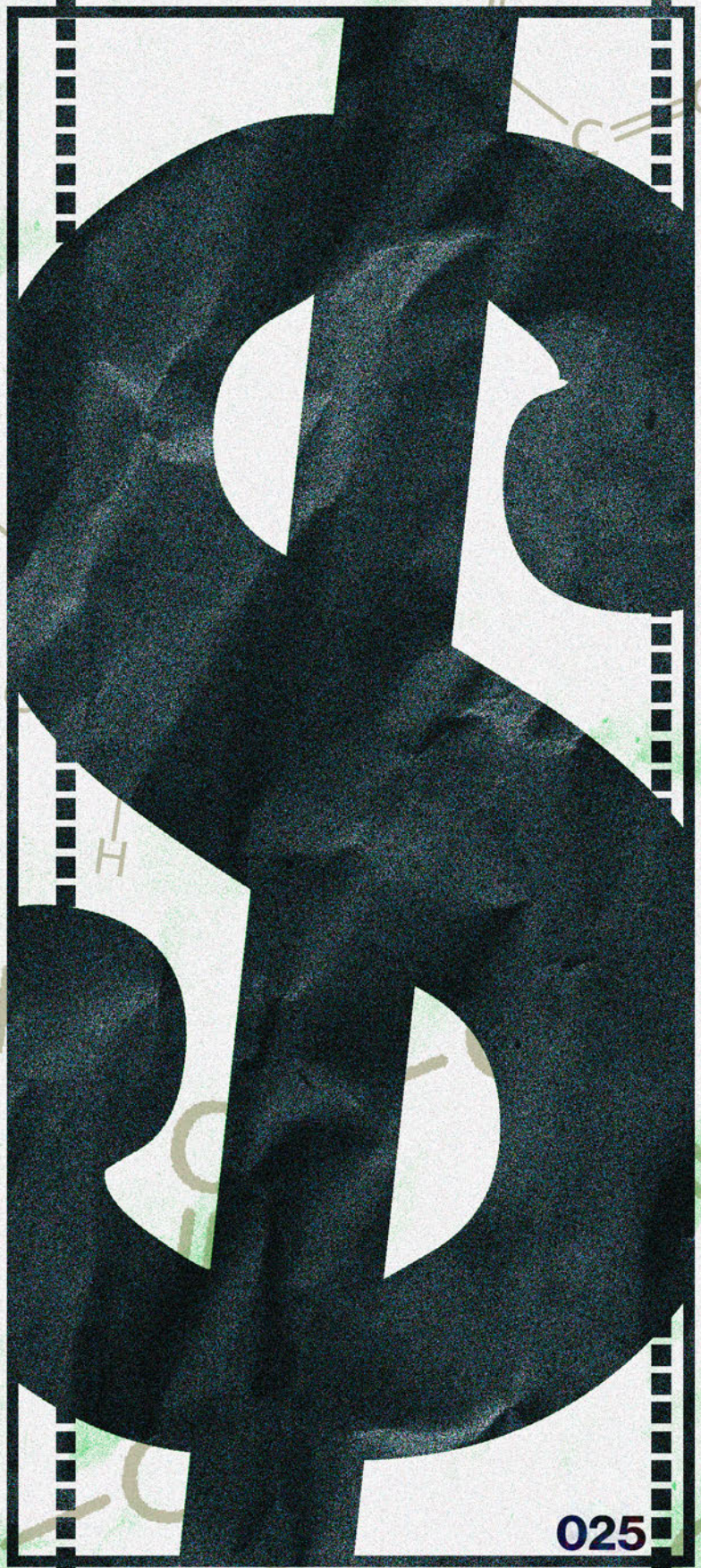

HARD RESET



decay

PAGE 26: ZULU

My biggest worry is that after our collapse, nothing so great and destructive could ever happen for another thousand years.

What if you were going to play a sport against someone who was technologically superior to you and had an advantage in numbers, abilities, finances, etc.

Their team is pretty stacked, and it's huge. It's so huge that anyone can join more or less without being really noticed/-vetted.

Isn't it a good idea to have a few of your own team members join them to drag them down?

How many wins you would take in a paintball tournament, if your enemy team had friendly fire accidents at the beginning of each round?

How many wins would you take in a volleyball tournament, if your enemy refused to ever pass, and always sent the ball flying in to their own side of the net at the beginning of each round?

Sure you could be a really good player on your own side, and hamper the efforts of one or even more of their teammates if you're really good; but among them you would be able to tie up the efforts of so many more. Throw your body on the ground for your enemy to trip over.

BECOMING THE ENEMY - GOLF

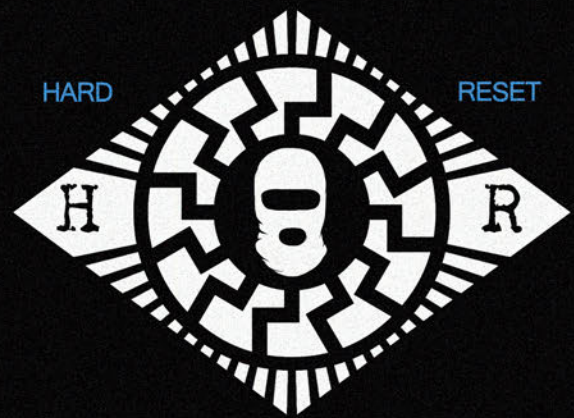

BECOME THE ENEMY FOR ALL THE RIGHT REASONS

CREATE A CONTROLLED OPPOSITION FOR THE ENEMY
TO WORRY ABOUT



Cool things I would do if I captured Xi Jinping in the future.

- Put him in a small room where he can't fully stand up, but can't fully sit down.
- Play Among Us music on loop very quietly constantly.
- White and blue light on max, coming from each of the four walls surrounding him. On 24/7.
- There's a toilet in his cell, but it won't flush and there's nothing to unclog it.
- Shave his head in random places, an eyebrow too.
- Give him no means to bathe or practice any type of hygiene for great periods of time.
- Hide a cellphone in his cell for him to find, when he finds it, every number he calls is just me.
- Put no bed in his cell, and make sure there's a leak which causes there to be 20mm of dirty water on the floor of the cell at all times.
- Give him randomized pharmaceuticals in his water ranging from Viagra to sleeping pills.
- Get him hooked on anti-psychotic and anti-anxiety pills only to deprive him of them later with no pattern.
- Put him outside in the winter with no way to keep warm for no reason at all.
- Inject him with saline while telling him it's actually random medications.
 - Show him fake news of the outside of his prison, showing the widespread rape of women in the countryside and cities of China by Taiwanese, Japanese, and North Korean troops.
- Put him in a pitch black box with no sound for long periods of time.
 - Put up a calendar he can see from the edge of his cell, with a 2030 date on it.
- Never let him see the outside, diminish and outright eliminate his perception of time.
- Convince him his execution is always one week from the current day.
 - Feed him a 100% carb diet.
 - Blind him for long periods of time.

OSCAR

21h ago

THE HARD RESET

Fuck arguing. If I see you post your wrong opinion online, I'm replying with your address.

30

Send a Chat

WEED IS FOR NIGGERS

DON'T.

IF YOU SMOKE WEED, YOU BECOME INCAPABLE OF CHANGING OUR WORLD IN ANY WAY FOR THE BETTER.

IF YOU SMOKE WEED, YOU BECOME INCAPABLE OF FORGING REALITY IN YOUR VISION.



IF YOU SMOKE WEED, YOU MAY AS WELL BE SMOKING SOYLENT.

IF YOU SMOKE WEED, YOU WILL BECOME SATISFIED WITH THE WORLD THE WAY IT IS.

GOOD MORNING
MURKIN

(O)SCAR

look, I know I' m calling at a bad
time, but don' t come to work in the
morning, or the day after that, or the
next one. I would hate to turn you into
burger meat while you turn an unborn
child into pulled pork, sorry, too morbid
- I apologize.
brief pause

32

CALLING THE DEAD BABY STORE

CALLING THE DEAD BABY STORE OSCVR

you' re thinking of beefing up security, huh?
heh, you know I can always just hit another
murder mill while yours is locked down, right?
you' re gonna be spending money hiring
bodyguards and buying equipment and I' m
gonna be watching it all from a nearby park
bench and you can' t do shit because I can see
you but you can' t see me, or maybe I' ll be
one of the protestors you just scowl at before
you get to work unaliving the unborn, or
maybe I' ll be the driver of one of the girls
who' s just coming to get tips on how to best
use hormonal birth control to ruin her
pairbonding ability as early as possible, or
maybe I' ll just get a job as the safety escort
and accompany the first one of your customers
all the way to the operating room and just
shoot you in the face with a concealed handgun
if you' d prefer to go out that way.

longer pause

that' s assuming I won' t just wait for you in
the parking lot after work and stab you to
death, you decide.

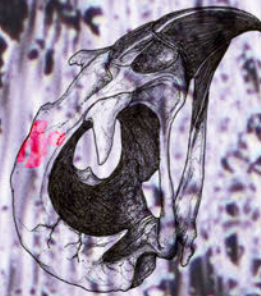

HARD RESET

WHILE I WAS READING
THIS BOOK, I FELT AN
EXTREME URGETO GO TO
A GAY NIGHTCLUB AND
BEGIN THROWING BRICKS
IN ALL DIRECTIONS

LIVE OUT OF YOUR RUCK
FIGHT FROM YOUR GEAR
SURVIVE OUT OF
YOUR POCKETS

HOMO HOMINI LUPUS - "A
MAN IS A WOLF TO
ANOTHER MAN" - I NEVER
REALLY WANTED TO EAT
ANOTHER MAN'S HEART
UNTIL READING THIS



EVERY ONE OF US NEEDS TO
INCREASE OUR
COMPETENCE FOR
CONDUCTING VIOLENCE.
WHITES, IN THE 20TH
CENTURY, LOST SOME WARS
AND WE ARE NOW LABELED
ILLEGALS ON THE PLANET
BY SOME SEMITIC MOUTH
REPRESENTING ZOG. THE
BELIEF THAT DEBATES,
LOGIC, OWNING THE LIBS,
OR ARGUMENTS ARE COOL
ARE FALSE, FOR THESE ARE
THINGS DONE IN TIMES OF
PEACE. WHILE
CONSERVATIVES MAY HAVE
FOOLED THEMSELVES THAT
WE ARE IN PEACE-TIME, IT'S
VERY EVIDENT TO
LITERALLY EVERY OTHER
SIDE IN THIS FIGHT THAT
WE ARE NOT. FOR PEACE TO
EXIST, ALL SIDES MUST
WANT PEACE.

OUR ENEMIES WANT US, THE
ILLEGALS, DEAD. IF WE
RESPOND WITH ANYTHING
BUT VIOLENCE THEN WE
WILL BE DEAD.

NO MORE SELF-CENTERED
VICTIM COMPLEX ABOUT
HOW "THE JEWS BANNED
THIS OR THAT AND NOW
WE HAVE TO BE EXTRA NICE
AND EXPRESS CLEAN OPTICS
SO THAT WE CAN MAKE
VICTORY WITHOUT BEING
BANNED OURSELVES!".

COMPETENCE



1/2

OF VIOLENCE





OF AIOGENE

2/2

COMPELENCE



GOLF, PAGE 35

IN CONTRAST TO THAT, I CAN THINK OF A FEW THINGS THAT MAKE A LOT MORE SENSE:

- PLA+ OR CF NYLON FILAMENT
- PARTS KITS
- HARASSING PEOPLE IN PUBLIC
- ALWAYS BEING DRESSED FOR A FIGHT
- TRAINING TO KILL
- LEARNING KICKBOXING
- PROFITING FINANCIALLY FROM CRIMES
- HURTING EVERYONE WHO ISN'T ON YOUR TEAM
- 48 LAWS OF POWER ROBERT GREENE
- FILTERING YOUR TAP WATER FOR FLUORIDE, CHLORINE, AND LEAD
- MALICE
- CHEAPEST APARTMENT YOU CAN FIND, HOLE IN THE WALL, CABIN IN THE WOODS
- DON'T PRIORITIZE STACKING FOOD WHEN YOU CAN JUST TAKE IT LATER



DOING ALL THESE AND MORE, AND EMBRACING THE MINDSET THAT YOU NOT ONLY WANT YOUR ENEMIES DEAD, BUT YOU WANT THEM ROTTEN, THEIR TEMPLES BURNED DOWN, THEIR WOMEN TIED DOWN FOR PASSERSBY, AND THEIR MEN MADE EXAMPLES OF; WILL BRING YOU CLOSER TO VICTORY THAN SHAPIRO-ESQUE TACTICS.

THE PEOPLE BUY THEIR OWN CHAINS IN THE 21ST CENTURY - CUTTING THE POWER FOREVER WILL BRING SOME OF THEM TO SALVATION

POWER WAS LYING IN THE STREET; WE PICKED IT UP

AWAKEN FROM THE NUMBING ANESTHETIC OF MODERNITY - IT'S CONTINUED EXISTENCE IS A GREAT CLOUD INSIDE YOUR HEAD

REAR RESET

THE HARD RESET



HAVE YOU EVER SEEN A JEW?

I DON'T MEAN THE DOMESTICATED KIND THAT
INHABITS THE MAJOR CITIES AROUND THE PLANET, I'M
TALKING ABOUT THE FELLAS IN THE BIG HATS WITH
SKULL CAPS UNDERNEATH AND A NOSE THAT TURNS
THEIR HEAD WHEN IT CATCHES A SIDE WIND...

HAVE YOU EVER SMELLED ONE LIKE THAT?

NO WONDER THEY SENT THEM TO THE SHOWERS!

EDUCATOR I

Some guy was telling me quick dry cement is EXTREMELY effective for derailing trains. I guess that's what a few of the Washington Eco-Terrorists did last year.



PUPIL II

What, like, just bring some Portland cement and mix it up on the tracks?



EDUCATOR III

Yeah, just mold it into a little 45° ramp to throw the front wheels off.



PUPIL IV

One guy could build a mold to make tiny concrete ramps quickly and repeatedly on all of the tracks in a junction... Fuck.



JULIET

41. 47922145633557, -74. 22376400766102

42. 248018219558716, -73. 81216302

42. 945777620512246, -74. 33888457183316

43. 42757437609283, -73. 4707208558569

PAGE-037



PAGE-037

"THERE WILL BE NO FRONT, NO PLACE WHERE ONE CAN TRULY SAY THE WAR BEGINS AND ENDS"

ILLEGAL MATERIAL



PASSAGE RAIL RAMP

JULIET

42. 91982602558626, -74. 60474934681

43. 53450358065245, -73. 40735277391859

43. 26201750233329, -73. 59138975370317

43. 09641138077279, -73. 888

43. 258, -73. 7099969998125

↵

**GUERRILLA
-Hotel**

Y

**FORMERLY AN OCCUPANT IN
TUNNELS, OR
A DUGOUT IN THE WOODS,
CONSUMING RICE OR ROOT
VEGETABLE FROM THE
EARTH, GROWN GOODS.**

↵

**WAITING FOR THE ENEMY
PATROL,
DIGGING,
SETTING TRAPS FOR HIS
ENEMIES, SPIKES IN A HOLE.**

↵

**TODAY, AN OCCUPANT OF AN
URBAN APARTMENT,
CONSUMING ONLY WHAT HE
NEEDS,
LAYING LOW,
OBSERVING THE CITY'S VILE
DEEDS.**

人

**SLEEPING DURING THE HOT
HOURS OF THE DAY,
OPPORTUNISTIC ACTION
DURING THE COOL NIGHT,
FRYING THE BRAIN, URBAN
SNIPING, OPPOSITION IN
SIGHT.**

↵

**HE CHOOSES THE BATTLES,
SETS THE TIMES,
HE'S YOU AND ME,
PLANNING OUR CRIMES.**

↵

**HE'S BETWEEN THE LINES OF
DRIFT,
UTILIZING DRONES,
3D PRINTED EXPLOSIVES,
NO GRIFT.**



SHANGHAI'D
IN
SHROOM
CITY

OSCAR



ICOPS!

硬重置

THE HARD RESET



SHANGHAI'D
IN
SHROOM
CITY

Passing by cops on the street feels funny. If only they knew, right? My infiltrator syndrome peaks every single time, and every single time they pass me by without giving me a second glance. Probably due to my grey man appearance - actual grey man appearance, might I add, I don't dress up like a guy who runs a prepping jewtube channel.

Fighting cops feels AMAZING - sticking it to authority while at the same time being reminded that you're not part of this fallen world and its rotten society is really quite the affirmation that you're on the right side. Plenty of times I'd start in a brawl fighting hooligans from a different city and end it fighting alongside them against the faceless mass of riot cops.

What feels best, however, is capturing them. They're not used to that. They much prefer the roles being reversed - or original, if you will - with YOU as the helpless captive, their plaything. Shame about all those detainees' rights and police regulations... good thing we don't need to abide by them.

There's a seldom-used storage room in the back of our little compound that we use as a holding facility. It only really fits a single person - two of them, if you cram 'em in there - and only has a crude latrine and a crappy sink that we put in rather hastily for this purpose.

There's a mirror above the sink. It serves to remind the prisoner of just badly he had to fuck up to end up captured by a paramilitary band of maniacs like us. Luckily for them, we usually collect ransoms quickly and send them on their way.

This time is different. I've come across a stash of shrooms and kidnapped the pig who was in possession of it - as it happens, he was the ADL's candidate for cop of the year in this part of the country. A shabbos goy through and through, deserving of a little...*special treatment*.

We gave him his dose just before sunset, then left him inside with nothing but the dark walls flanking him on all sides, the mirror providing the only distraction in the whole room. The brain does wacky things to a person's perception in cases like this one, even when you subtract the hallucinogenics from the equation. In Alcatraz they had a pitch-black room used for solitary confinement. A few days spent inside was enough to break even the most resilient spirit. Still, pitch-black darkness means you don't see anything, so you can tell yourself the things you begin to see and hear aren't real.

You don't have that luxury when you're tripping balls staring at the eldritch horrors in the mirror in a dimly lit room for 6 hours.



WOW! BILL GATES WAS BORN IN 1955,

THAT MEANS HE WALKED

THIS EARTH FOR XX YEARS UNTIL...

...YOU PUT HIM OUT ON
THE FLOOR SCREAMING,
COVERED IN HIS OWN
BLOOD AND SHIT.

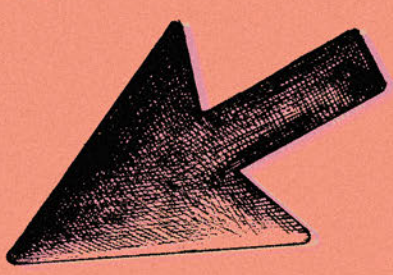

THE HARD RESET



THE HARD RESET
VICTIMHOOD, COMFORT
WRITER GOLF

##43

IN TIMES OF WORLDS PAST, WHEN XX WERE DOMINATING XXXX, THE XXXX LOST BRUTALLY BY NOT ACTING BUT INSTEAD COMPLAINING WHILE BEING DOMINATED THAT IF THEY HAD DONE THE VERY SAME, PEOPLE WOULD HAVE VILIFIED THEM.

THEY LOATHED ABOUT HYPOCRISY WHILE THEIR WIVES AND DAUGHTERS WERE SCOOPED UP FOR THE TAKING AS WAR BRIDES BY XX DURING RAIDS.

THEY MADE ARGUMENTS BASED ON FACTS AND LOGIC WHILE BEING THEMSELVES GUTTED BY XX.

THEIR LATE GAME - 250

SUGONDESE PLF - 123-124



THEY MAKE A SEXY M&M
THEN COMPLAIN ABOUT SAID SEXY M&M
THEN CALL YOU CRAZY FOR NOTICING

- OSCAR

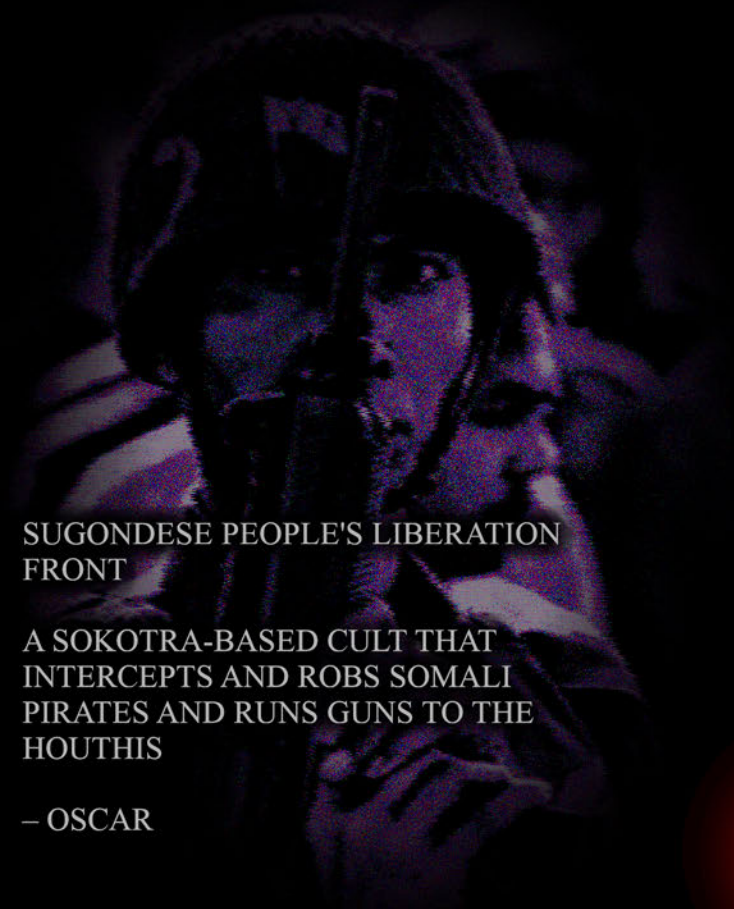

SUGONDESE PEOPLE'S LIBERATION
FRONT

A SOKOTRA-BASED CULT THAT
INTERCEPTS AND ROBS SOMALI
PIRATES AND RUNS GUNS TO THE
HOUTHIS

- OSCAR

COME OUT YE BLACKS AND BROWNS

CIVIC NATIONALISM IS A FEMALE
AFRICAN IMMIGRANT WHO LIVES IN
DUBLIN NOT LETTING A MALE
PAKISTANI IMMIGRANT LIVING IN
LONDON FUCK HER TO "GET BACK AT
THE BRITS IN THE NAME OF THE IRISH
NATION".

- OSCAR



"TALIBAN WILL TAKE OVER
AFGHANISTAN. GOOD. LET THE TRAITORS
LIVE - OR DIE, RATHER - WITH THE
CONSEQUENCES FOR THEIR ACTIONS."

- WRITTEN IN SUMMER 2021, SHORTLY
BEFORE THE TAKEOVER OF AFGHANISTAN
BY TALIBAN FORCES.

- OSCAR



891 - MSITANOLIAN

THAT HINDU KUSH HIT DIFFERENT - 217-218



**RETURN TO PICT
RETURN TO PICT
RETURN TO PICT**

UNIFORM

**WE WERE BRED FOR THIS.
WHETHER FOREIGN OR OF OUR
OWN RACE, TYRANTS HAVE
ALWAYS FEARED THE SCOTSMAN'S
WRATH.**

**THE ROMANS FEARED THE SCOT
THAT LAY BEYOND HADRIAN'S
WALL COVERED IN TATTOOS AND
IMPERIAL BLOOD.**

**THE ENGLISH FEARED THE SCOT
EVEN AFTER THEY "UNITED" OUR
HIGHLANDS WITH THEIR SMOGGY,
JEW FILLED CITIES, SO MUCH SO
THAT THEY EXILED MANY OF US
TO NORTH AMERICA AND
AUSTRALIA.**

**THE INDIAN FEARED THE SCOT
WHEN HE WAS CAST INTO THE
APPALACHIAN MOUNTAINS AND
WESTWARD, DRIVING THEM
NEARLY INTO THE SEA.**

**THE YANKEE AND THE NIGGER
FEARED THE SCOT ON THE
BATTLEFIELDS OF DIXIE.
BAGPIPES STRUCK FEAR INTO
THEIR HEARTS JUST AS THE
CARNYX STUCK FEAR INTO THE
HEARTS OF CLAUDIUS' AND
CAESARS' INVADERS.**

**ZOG WILL FEAR THE SCOT
ONCE MORE.**

**WE WERE DESTINED FROM
THE VERY BEGINNING -
SINCE THE VERY FIRST
COURSING OF THIS BLOOD
WE POSSESS IN THE VEINS
OF THAT SCOT OR PICT OF
OLD - TO FIGHT AND DIE ON
A BATTLEFIELD OF OUR
CHOOSING AGAINST AN
OCCUPIER; AN OCCUPIER
THAT HAS NO CONCERN FOR
OUR HISTORY, OUR
CUSTOMS, OUR LIVES, OUR
FAMILIES.**

**THE FIELDS ARE RIPE FOR A
HARVEST OF HEROES IN
AMERICA AND THE JEWS IN
THEIR HUBRIS HAVE DONE
THE SOWING FOR US, WHO
WILL DO THE REAPING? THE
SONS OF SCOTI, THE
GRANDSONS OF THE PICT.**

DECLARATION II

REACHING THE TOP OF A GREAT MOUNTAIN, YOU GAIN PERCEPTION INTO THE LAND BELOW; YOU SEE OUR WORLD BEING ERASED

I
PRESENT
I

007-045

II
FUTURE
II

046-084

III
IMPERFECT
III

085-121

IV
PERFECT
IV

122-176

V
FUTURE PERFECT
V

177-237

VI
PLUPERFECT
VI

238-253

HARD RESET



DECLARATION II INFORMATION

ALPHA - 1 PASSAGE
GOLF - 7 PASSAGES
HOTEL - 6 PASSAGES
KILO - 1 PASSAGE
NOVEMBER - 1 PASSAGE
OSCAR - 8 PASSAGES
QUEBEC - 1 PASSAGE
ROMEO - 1 PASSAGE
UNIFORM - 1 PASSAGE
WHISKEY - 3 PASSAGES
X-RAY - 1 PASSAGE
ZULU - 1 PASSAGE
TOTAL - 32 PASSAGES
39 PAGES

007 046 085 122 177 238

P.R.A.Y.

FOR

TERROR

HATRED WILL SET OUR RACE FREE / THOUGHTS TO ACT ON

POWER-LINES



HATRED OF POWER-LINES

THE SUPER POWER, RELIED ON BY ALL.

TO KEEP HOMES WARM IN THE WINTER, TO HEDONISTICALLY KEEP THEM COLD IN THE SUMMER.

ELECTRICAL COMFORT, THE ABILITY TO KEEP ONESELF IN THE PERFECT CLIMATE AT ALL TIMES.

EVERY PERSON OWNING CONVENIENT ELECTRIC DEVICES, CAPABLE OF MAKING ANYTHING EASY.

THE CITIES LITTERED WITH STREET LIGHTS, CAMERAS, MOTION DETECTORS, SECURITY SYSTEMS FOR THE RESIDENTIAL, COMMERCIAL, AND INDUSTRIAL SECTORS.

THE LAST THING STOPPING PEOPLE FROM EATING ONE ANOTHER.

BURNING NATURAL RESOURCES; FILLING THE SEA, LAND, AND SKY WITH POLLUTANTS SO SITCOMS CAN BE LOVED. SO PEOPLE CAN MASTURBATE WITH EASE.

WASTING OIL, COAL, URANIUM, RARE EARTH METAL, AND TIME.

RIP THROUGH A FEW PLANTS AT THE SAME TIME, AND YOU'LL MAKE TIMELESS DIFFERENCES.

RAILWAYS



HATRED OF RAILWAYS

DEGENERACY DELIVERED BY RAIL.

VEHICLES, SOMETIMES FOR CONSUMERS AND OTHER TIMES FOR MILITARY VENTURE.

OIL, CORN, CATTLE, AND ALL OTHER THINGS THAT KEEP THE SICKNESS RIDDEN BODY OF THE SYSTEM WORKING.

MORE OCEAN POLLUTING PLASTIC THAN YOU CAN IMAGINE, LOADED OFF OF SHIPS AND ON TO LOCOMOTIVES TO BE SENT ALL OVER THE COUNTRY.

SEX TOYS, FOREIGN FRUIT, USELESS ELECTRONICS, FENTANYL, AND GAY PRIDE FLAGS SHIPPED BY TRAIN TO POLLUTE THE BODY AND MIND.

SMASH THE JUNCTION BOXES TO MAKE A DELAY WHEN NEEDED. SMASH THE TRACKS, TIES, AND BRIDGES TO MAKE A REAL DIFFERENCE.

THE FLAME RETARDANT TIES CAN BE BURNED WITH ENOUGH FUEL.

THE TRACKS CAN BE CUT THROUGH AND MELTED WITH ENOUGH THERMITE.

THE TRACKS CAN BE TOYED WITH, USING PORTLAND CEMENT TO CAUSE DE-RAILINGS.

AGRICULTURE



HATRED OF AGRICULTURE

FIELDS OF CORN, SOY, SEED, AND ROOT PROVIDING SUSTENANCE TO THE DIRTY THIRD-WORLD MASSES WHO RIDDLE THIS WORLD.

ENDOCRINE DISRUPTING SEED OILS AND LECITHINS FED TO BABIES TO LOCK-IN THEIR FUTURE DISFORMED TRAITS.

THE FEED OF CATTLE, PLANTED, HARVESTED, CHURNED, AND FED TO CATTLE IN THE FORM OF A SPICY CHIP.

CHEMICAL FERTILIZER, POTASSIUM NITRATE, DUMPED BY THE MEGATON ON BARREN SOILS, COMPLETELY LACKING TOP-SOIL DUE TO MODERN FARMING TECHNIQUES AND ADVANCED STAGES OF RUN-OFF AND EROSION.

THE FIXED FOOD SOURCE, KEEPING THE MASSES COMPLACENT AND CASTRATED, UNAWARE OF THE POISONS WITHIN THEIR CHEAP FLASHY MEALS.

SALT THE LANDS, BURN THE FERTILIZER PLANTS DOWN. RIDE AN ATV THROUGH FIELDS OF SOY WITH A GAS MASK ON. DESTROY AS MANY CROPS AS YOU CAN. FREE YOUR PEOPLE.

YUPPIES



HATRED OF YUPPIES

YUPPIES SITTING IN THEIR LILY-WHITE McMANSIONS UNAWARE OF THE WORLD THEY FUND AROUND THEM.

THE BIGGEST CONSUMERS OF FUNKO-POPS, MARVEL FILMS, PORN, AND CORN-BASED PRODUCTS.

THEY STOMP ALL OVER THIS EARTH AND ITS NATURAL RESOURCES LIKE IT'S THEIR OWN.

THEY THINK THEY'RE ABOVE NATURE.

THEY WON'T STOP EXPANDING LIKE WRITHING PARASITES.

YUPPIES OF EVERY RACE ARE MADE UNEASY BY ANY VISIBLE GREEN SPACE IN SIGHT.

THEY WON'T STOP UNTIL THE WHOLE WORLD IS PAVED OVER; ANOTHER SUBDIVISION, ANOTHER CONDO, ANOTHER WALMART, THE YUPPIE NEEDS THESE THINGS.

THE YUPPIE LOVES IT'S THIRD WORLD SLAVES, HERE TO PICK FOOD AND RE-PAVE THE DRIVEWAY.

PULL THEM BY THEIR HAIR PASSED THEIR LEXUS AND IN TO THE ROAD WHERE YOU CAN WASTE NO MORE THAN A CHEAP CORROSIVE 7.62x39 ROUND, DISPENSING OF THEM AT MAXIMUM EFFICIENCY.

HATRED

OF

P.R.A.Y.

WILL SET OUR RACE FREE



POWER-LINES SUPPORT THE CULT OF DEATH. YOU BELONG TO THE CULT OF LIFE. REMOVE POWER-LINES AT ONCE.

ALWAYS WEAR A MASK FOR YOUR SAFETY.

EXPLOSIVES MAY BE USEFUL AGAINST SUB-STATIONS AND OTHER DIRECT INFRASTRUCTURE.

FUEL MAY BE USED IN THE SAME PLACES AT THE ABSENCE OF EXPLOSIVES. FUEL CAN BE USED TO BURN WOODEN TRANSMISSION POLES DOWN.

A FIREARM SHOULD ALWAYS BE CARRIED FOR YOUR SAFETY. A FIREARM CAN ALSO BE USED TO ELIMINATE SENSITIVE SUB-STATION COMPONENTS AT A DISTANCE SUCH AS COOLING COMPONENTS.

HAND TOOLS CAN HELP YOU GAIN ACCESS TO RESTRICTED AREAS.

POWER TOOLS SUCH AS SAWS AND GRINDERS WILL ALLOW YOU TO TAKE DOWN TRANSMISSION INFRASTRUCTURE.

A KNIFE WILL NOT HELP YOU.

A PHONE SHOULD NEVER BE CARRIED FOR YOUR SAFETY.

A GET-AWAY VEHICLE IS ALWAYS NECESSARY FOR YOUR SAFETY.



RAILWAYS SERVE THE CULT OF DEATH. YOU BELONG TO THE CULT OF LIFE, REMOVE RAILWAYS AT ONCE.

ALWAYS WEAR A MASK FOR YOUR SAFETY.

EXPLOSIVES, IN PARTICULAR THERMITE CAN BE USED TO DISFIGURE TRACKS.

FUEL CAN BE USED IN QUANTITY TO BURN EVEN FLAME RETARDANT TIES.

A FIREARM SHOULD ALWAYS BE CARRIED FOR YOUR SAFETY.

HAND TOOLS WILL ALLOW YOU TO REMOVE IMPORTANT COMPONENTS FROM THE RAILS, SUCH AS THE SPIKES.

POWER TOOLS CAN HELP YOU DESTROY THE GRADE AROUND THE TRACKS, OR TO CUT COMPONENTS OF THE TRAINS THEMSELVES.

A KNIFE WILL NOT HELP YOU.

A PHONE SHOULD NEVER BE CARRIED FOR YOUR SAFETY.

A GET-AWAY VEHICLE IS ALWAYS NECESSARY FOR YOUR SAFETY.



AGRICULTURE PRODUCES THE CULT OF DEATH. YOU BELONG TO THE CULT OF LIFE, REMOVE AGRICULTURE AT ONCE.

ALWAYS WEAR A MASK FOR YOUR SAFETY.

EXPLOSIVES CAN BE USED ON GRAIN SILOS AND ON FERTILIZER OPERATIONS TO CRIPPLE AGRICULTURE ON AN EXTREME LEVEL.

FUEL CAN BE USED TO START FIRES INSIDE OF ALREADY EXPLOSIVE FERTILIZER OPERATIONS. OR TO BURN DOWN BARN.

A FIREARM SHOULD ALWAYS BE CARRIED FOR YOUR SAFETY.

HAND TOOLS CAN BE USED TO HELP YOU GAIN ACCESS TO RESTRICTED AREAS.

POWER TOOLS AND MACHINERY CAN HELP YOU RIP UP THE CROPS ALREADY PLANTED.

A KNIFE WILL NOT HELP YOU.

A PHONE SHOULD NEVER BE CARRIED FOR YOUR SAFETY.

A GET-AWAY VEHICLE IS ALWAYS NECESSARY FOR YOUR SAFETY.



YUPPIES EMBODY THE CULT OF DEATH. YOU BELONG TO THE CULT OF LIFE, REMOVE YUPPIES AT ONCE.

ALWAYS WEAR A MASK FOR YOUR SAFETY.

EXPLOSIVES DESTROY EVERYTHING THE YUPPIE 'BUILT' FOR ITSELF.

GAS BURNS DOWN THE YUPPIE'S HOME. FLAME ELIMINATES EVIDENCE.

A FIREARM CAN BE USED TO HURT, COMMAND, AND KILL THE YUPPIE.

HAND TOOLS ALLOW YOU TO CUT THE POWER TO THE YUPPIE, AND TO GAIN ACCESS TO IT'S HOME. TOOLS DISABLE THE YUPPIE'S VEHICLES.

POWER TOOLS ALLOW YOU TO DISABLE THE LINES THAT ALLOW THE YUPPIE TO CALL OUT AND TATTLE ON YOU.

A KNIFE CAN HELP YOU QUIETLY DISABLE AND ELIMINATE THE YUPPIES.

A PHONE SHOULD NEVER BE CARRIED FOR YOUR SAFETY.

A GET-AWAY VEHICLE IS ALWAYS NECESSARY FOR YOUR SAFETY.

HATRED

AND

TERROR

WILL RETURN NATURAL ORDER AT ONCE

P

OWER-LINES



THE PRICE OF TRANSFORMERS RANGES FROM TWO-MILLION USD TO SEVEN AND A HALF MILLION USD DEPENDING ON ITS VOLTAGE RATING AND SIZE.

THE LEAD TIME OF ELECTRICAL GRID SETUP IS 18 MONTHS FROM REQUEST TO TESTING PERIOD. IT CAN ALL BE DESTROYED IN A SECOND AT ANY PHASE.

THE WESTERN ELECTRICAL GUIDE CONSTRUCTION PROCESS IS RELIANT ON FOREIGN COMMON AND EXOTIC MATERIALS IN ORDER TO MANUFACTURE. SILICON, IRON, ELECTRICAL STEEL, ALUMINUM, NEODYMIUM, OIL, AND COPPER. MATERIALS CONSTITUTE 50% OF THE COST OF MANUFACTURING.

LARGE POWER TRANSFORMERS REQUIRE SPECIAL RAIL CARS FOR TRANSPORTATION. ONLY 30 OF THESE CARS EXIST IN NORTH AMERICA.

R

AILWAYS



IN THE UNITED STATES, THERE ARE 140,490 MILES OF STANDARD HAULING GAUGE TRACK.

TRACKS ARE GENERALLY UNGUARDED, BUT WHEN THEY ARE GUARDED IT'S USUALLY BY HIGH QUALITY CAMERAS UTILIZING THE INFRARED LIGHT SPECTRUM AND THERMAL IMAGING.

THE TRACKS ARE EASILY DAMAGED. A SABOTEUR COULD CAUSE A TRAIN TO DERAIL BY USING PORTLAND CEMENT TO BUILD SMALL RAMPS ON THE TRACKS. A TRAIN COULD BE DERAILED BY WELDING LENGTHS OF REBAR TO IT.

STATIONED UNGUARDED TRAINS ARE SUSCEPTIBLE TO ATTACKS ON THEIR BRAKES AND EXPOSED LINKING COMPONENTS. IF KIDS WITH SPRAY PAINT CAN TAG THEM AND GET AWAY WITH IT, THEN YOU HAVE ENOUGH TIME TO ATTACK THEM.

JUNCTION BOXES ARE PRESENT AT MOST CROSSINGS AND JUNCTIONS. THEY ARE EASILY OPENED AND THEIR WIRES DAMAGED.

A

GRICULTURE



THERE ARE OVER TWO MILLION FARMS ACROSS THE UNITED STATES, AND THE AVERAGE FARM IS 444 ACRES LARGE.

THE CURRENT CROP EXPORT BRINGS THE UNITED STATES OVER 135 BILLION USD. THESE CROPS ARE USED TO PROP UP POPULATIONS WHICH ARE AGAINST NATURAL ORDER ON DISEASED CONTINENTS.

MODERN COMMERCIAL FARMS ARE DEPENDANT ON POTASSIUM NITRATE BASED CHEMICAL FERTILIZERS. THESE COME FROM A SMALL HANDFUL OF PLANTS LITTERED AROUND THE UNITED STATES WHICH ARE SUSCEPTIBLE TO EXTREME ATTACK.

FARMERS CAN GENERALLY NOT DEFEND THEIR CROPS AGAINST WILD HOGS, AND LOSE ASTOUNDING PROFITS EACH YEAR.

COMPANIES LIKE MONSANTO, AGRIUM, CHINESE GREEN, AND EVOGENE ARE PROFITING POISONERS OF THE LAND.

Y

UPPIES



UPPER MIDDLE CLASS HOMES ARE BUILT WITH THREE THINGS IN MIND: AESTHETICS, PRICE, AND CONVENIENCE.

THESE HOMES ARENT BUILT FOR SECURITY. THEY ARENT BUILT STRONG. THEIR OVERINFLATED PRICES DONT REFLECT A SUPERIOR BUILDING MATERIAL OR BUILDING TECHNIQUE. THESE HOMES ARE MADE FROM PAPER MACHE AND FOREIGN UNSKILLED SPIC LABOR.

THESE HOMES CAN BE EASILY BROKEN IN TO. 66% OF MIDDLE CLASS HOMES NOW HAVE SOME DEGREE OF SECURITY SYSTEM PRESENT. MAKE NOTE OF THIS FACT.

THE PEOPLE INSIDE OF THEM, THE SOFTEST HISTORY HAS EVER SEEN. MIDDLE MANAGEMENT, SLIDESHOW MAKERS, DIVERSITY AND EQUITY OFFICERS.

EASILY COMMANDED TO THE FLOOR AND PUT OUT OF THEIR FLACCID MISERY.

DONT WANT TO GET YOUR HANDS DIRTY? BREAK A WINDOW AND THROW A WATER BOTTLE FILLED WITH BLEACH AND AMMONIA IN. COME BACK IN A FEW DAYS TO ROB THE PLACE.

MINOR CRIMES

MINOR CRIMES ARE MY DRUG *and I'm craving again*

OSCAR
050

pretending to call my dog as I crouch down to loosen custom caps on the valves of car wheels in the inner city

I desperately need my fix, it's like getting an itch just after you've clipped your fingernails, a maddening inconvenience

what matters is the violation itself, more so than its scope

you could enter a classy Italian restaurant dressed as a repairman and carrying a step ladder just to go in the kitchen and pour heavy cream in the carbonara sauce

or you could give rap concert attendees the authentic Norwegian summer camp experience

at the end of the day you've orchestrated confusion and anger and potentially pushed a few joe sixpacks over the edge

we engage in a mild amount of tomfoolery





THE HARD RESET



UNIF

CAR BOMBS

"...CAR BOMBS ARE EXTRAORDINARILY CHEAP: 40 OR 50 PEOPLE CAN BE MASSACRED WITH A STOLEN CAR AND APPROXIMATELY \$500 OF FERTILIZER AND BOOTLEGGED ELECTRONICS. RAMZI YOUSEF, THE MASTERMIND OF THE 1993 ATTACK THAT CAUSED AN ESTIMATED \$1 BILLION DAMAGE TO MANHATTAN'S WORLD TRADE CENTER, BRAGGED THAT HIS MOST EXPENSIVE OUTLAYS WERE LONG-DISTANCE PHONE CALLS: THE EXPLOSIVE ITSELF (ONE HALF TON OF UREA) COST \$3615 PLUS THE \$59 PER DAY RENTAL FOR A TEN-FOOT-LONG RYDER VAN. TIMOTHY MCVEIGH, LIKEWISE, SPENT LESS THAN \$5000 ON FERTILIZER, RACING FUEL, AND VAN RENTAL FEES TO BLAST THE FRONT WALL OFF THE ALFRED P. MURRAH FEDERAL BUILDING AND KILL 168 PEOPLE IN OKLAHOMA CITY IN 1995. IN CONTRAST, THE CRUISE MISSILES THAT HAVE BECOME THE CLASSIC AMERICAN RIPOSTE TO OVERSEAS TERRORIST ATTACKS COST NEARLY \$1 MILLION."

#51-####

HOTEL



THE
JOY
OF
HARMONY



HARD RESET

IF NATURE WORKED TOGETHER FOR A DAY

SWARMS OF INSECTS HARASSING THE COMMON MAN,
BIRDS TEARING APART SECURITY SYSTEMS,
A BEAR CHASING THE POLICE AWAY.

PLANTS GROW UP THROUGH THE FLOORBOARDS AND IN TO THE CRACKS OF ANY FOUNDATION,
FUNGUS AND MOLD SPORES TURNING ORGANIC MATTER TO RICH SOIL,
VEHICLES, MACHINERY, AND EQUIPMENT DEGRADED TO RUST.

AN ECO-SYSTEM REPLACES THE CRACKED ASPHALT ONCE TRACKED UPON.

IF WHITES WORKED TOGETHER FOR A DAY

SWARMS OF COMMON MEN, HARASSING ALIEN INVADERS, MIGRANT SHOP AND HOME BURNED BY DAY; THEIR OCCUPANTS DISPLACED BY NIGHT, AN ARMED MAN CHASING THE POLICE AWAY.

COMMUNITIES FORM FROM THE BOTTOM UP, CREATING TIMELESS AND UTILITARIAN STRUCTURE, THE YOUTH COLLABORATING IN THE RUINS, TRANSFORMING THE OLD WORLD TO DUST, THE OLD NEO-LIBERAL WAY, PERVERSION, AND DECADENCE, REPLACED.

AN ORGANIC STATE REPLACES THE DECAYING SYSTEM ONCE RELIED UPON.



**THE
JOY
OF
HARMONY**



HARD RESET

BOYS DON'T CRY

They want us to show weakness, to crack under pressure. Why? To seem more human? Humans aren't inherently weak; we've come to dominate the earth. The real reason is that they're afraid of us and are desperate to get us to seem pathetic and helpless to get around this fear.

To this we can only offer one single counterpoint - you *WILL* fear us, because you *KNOW* what we will do to you. You *WILL* fear us because unlike you, we have nothing to lose and everything to gain. You *WILL* fear us because we will seize the world and *TEAR* it from your talons; regardless of how hard you grip it, you'll only be left hanging onto shreds which will fall to the ground, pitiful and insignificant, just like the beast that used to hold them.

DIY WEAPONS CRAFT

PAGE 56, X-RAY

Legend (Ingredients)

	Black Powder
	Potassium Nitrate
	Charcoal
	Sulfur
	Water
	Isopropyl Alcohol, 70%

Legend (Equipment)

	Heat Source (electric)
	Metal or Plastic Bucket
	Pan or Skillet, 4 quart
	Window Screen
	Wooden Stirring Stick
	Cloth
	8-ounce Measuring Cup

Black Powder Trivia

- Black Powder is a "Low-Explosive"! This means it is easily ignited, but to explosive, it has to be confined inside of a container like a gun barrel or canister.
- It is still common today mainly because no suitable alternative has been found!
- Charcoal and sulfur are the fuel part of black powder, while potassium nitrate is the oxidizer!
- If mixed dry, or tamped too hard, it could explode while being made. Black Powder is best made in **small batches!**

Simple Black Powder Crafting



1 Procure all materials and equipment, ensuring everything is clean and in working order.

- 3 cups, granulated or powdered
 - 2 cups, finely powdered
 - 1/2 cup, finely powdered
 - 3 cups
 - 10 cups, can substitute vodka.
- 2** Secure all ingredients in the above quantities. Measurement is key.



3 Mix everything except the alcohol in the pan, and use the wooden stir stick to mix thoroughly, and carefully.

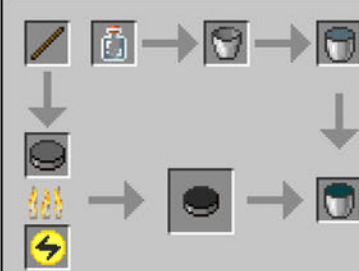

4 Prepare the bucket by pouring all of the alcohol in to it, and setting it nearby.

Heat the slurry over your electric heat source while ensuring it does not boil or begin to dry at the edges.

When the first bubbles appear, pour it in the bucket and stir briefly. Let it stand for 5 minutes. Stir the alcohol in the bucket during this.



5 To collect the black powder, strain the contents of the bucket through your cloth. Remove as much liquid as possible by wrapping the cloth around the ball, twisting it up, and squeezing vigorously.

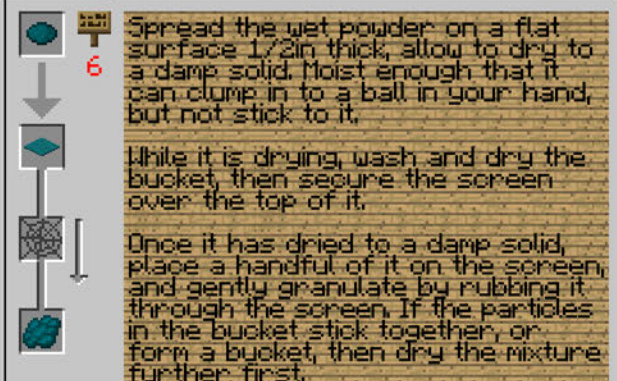

6 Spread the wet powder on a flat surface 1/2in thick, allow to dry to a damp solid, moist enough that it can clump in to a ball in your hand, but not stick to it.

While it is drying, wash and dry the bucket, then secure the screen over the top of it.

Once it has dried to a damp solid, place a handful of it on the screen, and gently granulate by rubbing it through the screen. If the particles in the bucket stick together, or form a bucket, then dry the mixture further first.

7 Sun-dry this granulated black powder mixture completely by again spreading it on a flat surface no more than 1/2in thick under the sun outside. The more quickly the powder is dried, the better quality it will be. Never dry over a direct heat source. Store in small quantities in static-free plastic containers.

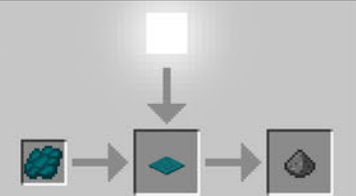

THE WILDCRAFT

PAGE 57, X-RAY

Legend (Ingredients)

	Gasoline
	Motor Oil (used/new)
	Styrofoam
	Napalm
	Red Iron Oxide (rust)
	Aluminum Powder
	Thermite
	Bleach
	Ammonia

Legend (Equipment)

	Metal or Plastic Bucket
	Cannister (glass/metal)
	Jar
	Wooden Stirring Stick

Crafting Trivia

- The Napalm recipe shown is for a simple improvised form, but will still burn hot, stick to a target, and flow around it like military grade Napalm!
- Thermite will separate while being moved around, it's best to ensure it's adequately mixed before using. This can be fixed by adding heated sulfur to the mix.
- Thermite is very hard to light! Most players utilize magnesium ribbon, a firework sparkler, or a blowtorch to light it.
- Most people killed by homemade Chlorine Gas are the players trying to make it. Be careful!

Simple Napalm Crafting

1 Procure all materials and equipment, ensuring everything is clean and in working order.

	1 gallon
	1 gallon
	As much as can be found

2 Secure all ingredients in the above quantities. Measurement is not as important with napalm as it is with other crafting.

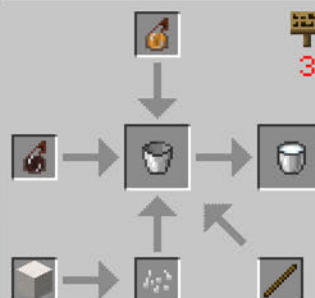

3 Pour the gasoline in to the bucket. Add motor oil and broken up bits of styrofoam until the mixture has reached a thick and sticky consistency. Adding too much oil and styrofoam will cause the napalm to stick to objects better, but will affect flammability. Find a gel consistency that works for you. Do this outside, due to dangerous fumes.

4 Place the mixture in several containers and store air-tight until use. It may require stirring before use due to separation if stored for a long period.

Simple Thermite Crafting

1 Procure all materials and equipment, ensuring everything is clean and in working order.

	3/4lb
	1/4lb

2 The quantities above can be scaled freely. Iron Oxide always makes up for 75% of the thermite while the aluminum Dust makes up 25%. The above quantities will therefore make a pound of Thermite.

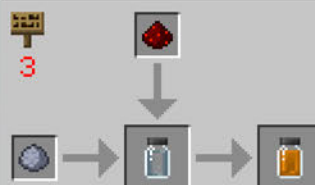

3 Simply mix in a jar or container, shake and stir to ensure ingredients are sufficiently mixed.

Always wear your safety equipment! **Safety glasses**, a pair of **gloves**, and a **Respirator** will save your life!

Bonus: Simple Chlorine Gas Crafting

Outdoors while wearing respiratory protection and gloves, mix the Bleach and ammonia in an air-tight jar or bottle together. The gas produced is Chlorine Gas.

THE HARD RESET

POWER WAS LYING IN THE STREET WE PICKED IT UP



HOW LETHAL ARE YOU?



ARE YOU A THREAT?

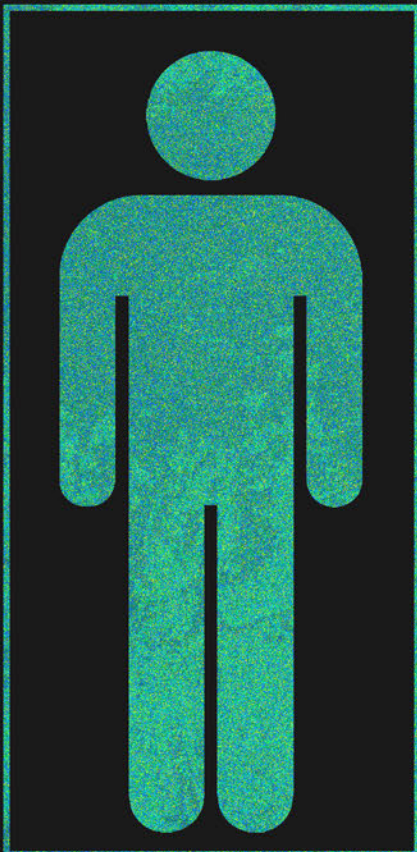

HELMET, COMMS, PUSH-TO-TALK, TASK LIGHT, NIGHT FIGHTING EQUIPMENT, HEARING PROTECTION, BATTLE DRESS UNIFORM, PLATE CARRIER, PLATES, MAGAZINE POUCHES, ADMIN POUCHES, DROP POUCH, IFAK (CHEST SEALS, TOURNIQUETS, BANDAGES, SLING, MEDICINE, PAIN KILLERS), WATER, FOOD, MESS KIT, RUCK, CORDAGE, WATER FILTRATION, WATER STERILIZATION, KNIFE, GLOVES, BUILT IN KNEEPADS, BOOTS, WOOL SOCKS, EXTRA SOCKS, RIFLE, SPARE AMMUNITION, SLING, OPTIC, WEAPONLIGHT, MUZZLE DEVICE, FOREGRIP, SPARE PARTS, CLEANING KIT, COMPASS, MAP, PERSONAL GPS UNIT, PEN/MARKING TOOLS, SPARE BATTERIES.

GOLF

58

ABOVE ALL, TRAINING WITH YOUR EQUIPMENT.

*USE A
MORTAR*

*TO
STRIKE
THEM*

*THROUGH
A HOLE*

*IN THE
CLOUDS*

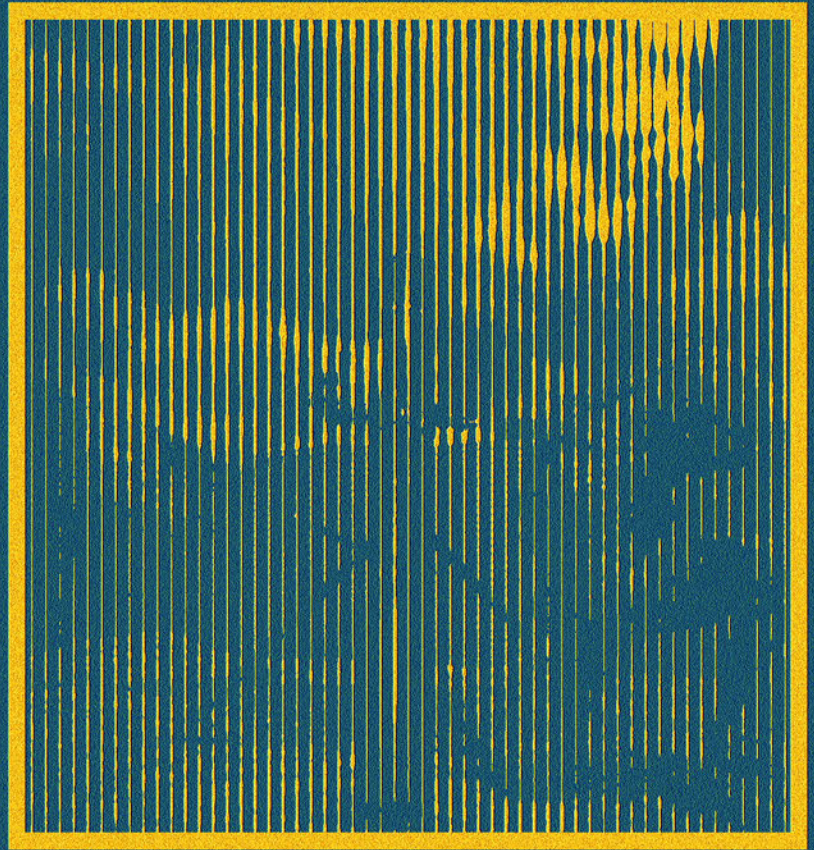

//THE HARD RESET//



ANDRINE Espeland, 17. Three gunshot wounds to head and chest.

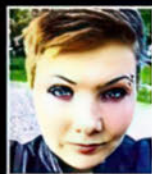

SILJE Merete Fjellbu, 17. Shot six times — once through temple.



BENDIK Rosnaes Ellingsen, 18. Shot eight times, including twice in head.



TROND Berntsen, 51. Shot three times — in head, back and chest.



LEJLA Selaci, 17. Teenager was shot twice in the head.



RUNE Havdal, 43. Blasted five times in head, chest and abdomen.



MARGRETHE Boeyum Kloveen, 16. Shot three times in the head.



IDA Beathe Rogne, 17. Was shot twice in the head and face.



GUNNAR Linakar, 23. Killed by a shot to the back of the head.



HANNE Kristine Fridtun, 19. Was shot three times in the head.



ISMAIL Haji Ahmed, 20. Suffered single gunshot wound to the head.



MARIANNE Sandvik, 16. Bled to death after being shot in the pelvis.



JOHANNES Buo, 14. Shot three times in the throat and forehead.



SYVERT Knudsen, 17. Shot three times — twice in head, once in back.



SYNNE Roeyneland, 18. Girl was shot in the head three times.



JAMIL Rafal Yasin, 20. Shot twice — once through her throat and skull.



SNORRE Hoffer, 30. Blasted three times in the head and back.



MONICA Boel, 45. Suffered three gunshots to the head.



CARINA Borgund, 18. Shot three times, including twice in head.



RONJA Sottar Johansen, 17. Blasted three times in head and back.



ISABEL Victoria Green Soga, 17. Shot three times, once in temple.



INGRID Berg Hegglund, 18. Three shots — including one to the head.



TINA Iversen Sukuvara, 18. Was blasted once in the head.



ANDREAS Edvardsen, 19. Shot three times in the head and neck.



KARIN Elena Holst, 15. Suffered a single gunshot wound to the head.



FREDRIK Lund Schjetne, 18. He was blasted once in the head.



KARAR Mustafa Qasim, 19. Shot twice in the back.

//WHISKEY//

MEMORIALS *are our* MONUMENTS



THOMAS Margido Antonsen, 16. Was shot twice in head and throat.



TORJUS Jakobsen Blattmann, 17. Killed by one shot to the head.



STEINAR Jessen, 16. He was shot twice — in head and chest.



ANDERS Kristiansen, 18. Blasted twice in the head.



MONA Abdinur, 18. Shot three times — in her head and back.



AASTA Sofie Heland Dahl, 16. Shot twice through lung in the head.



TORE Eikeland, 21. Breivik killed him with a single shot to the head.



ALEKSANDER Aas Eriksen, 16. Shot six times, including twice in the head.



ELISABETH Trønnes Lie, 16. Teenager was blasted twice in the head.



EMIL Okkenhaug, 15. Killed by three gunshots — two of them to the head.



HENRIK Andre Pedersen, 27. Killed by three gunshots to the head.



TARALD Kuvén Mjelde, 18. Shot five times, including in face and back.



HAAVARD Vederhus, 21. Shot four times, including in back and neck.



EVA Kathinka Lütken, 17. Shot twice through throat and head.



SHARIDYN Svebakk-Bohn, 14. Shot twice through lung and chest.



BIRGITTE Smetbak, 15. Shot twice through shoulder and back of knee.



EIVIND Hovden, 15. Shot three times, including blow to the head.



SONDRE Furseth Dale, 17. Shot four times through throat and chest.



SVERRE Flate Bjørkvaag, 28. He was shot twice in the head.



GURO Vartdal Havoll, 18. Shot three times, including once in head.



HAKON Odegaard, 17. Drowned trying to escape from the gunfire.



SILJE Stamneshaugen, 18. Shot three times through the head.



HANNE Fjærestad, 43. Shot three times — twice in head, once in back.



DIDERIK Aasmott Olsen, 19. Shot in head, died on boat back to mainland.



MONICA Iselin Didriksen, 18. Shot twice, including once in her face.



KEVIN Daae Berland, 15. Shot three times in the head and throat.



GIZEM Dogan, 17. Breivik shot her twice, once through her left eye.



UNTIL TOTAL ARYAN VICTORY IS ACHIEVED, MEMORIALS ARE OUR MONUMENTS.

Utøya Island, where Saint Anders Breivik massacred 69 traitor elites and wounded 110 on July 22, 2011, has been turned into a permanent memorial. New structures were added but the crime scene was preserved. The walls, riddled with bullet holes, remain to this day. Powerful stuff.

To THEM, a shrine to the victims. A warning to the world about the "dangers of right wing extremism."

To US, a shrine to the Saint who victimized them. A warning to the world about treason, and what can and will happen when White Men are pushed too far.

Taking out a few insignificant targets might get you a candlelight vigil with crudely drawn signs and flowers, but a high enough score will get you a permanent installation.

Kill important people. Kill a lot of people.
(Ideally both - it's possible with enough planning.)

Don't just strike - STRIKE WITH A PURPOSE.

Strike the very heart and lifeblood of the System itself. Cause devastation so severe, it can't be ignored. Inflict lasting damage that time won't heal. Make sure they NEVER FORGET who you are or what you've done.

**Leave the System NO CHOICE
but to erect a memorial in YOUR honor.**



AFFIRMATION

I LEAD AN ACTIVE LIFE OF **TRAINING** AND **PREPARATION** FOR THINGS TO COME.

I WILL ACKNOWLEDGE MY WEAK POINTS & MOVING FORWARD AND ENSURE EXTRA ATTENTION FOR THEM UNTIL I AM A **MASTER OF MYSELF** AND A **WARRIOR FOR MY RACE**





BATTERY OPERATED



JACKHAMMER



HAMMER DRILL



GRINDER



CUT-OFF SAW

Direct great damage. Do so in the 21st century where every destructive device you could ever seek is made to run cordless, convenient for when you're doing **CRIMINALLY APPROVED** things in the woods alone.

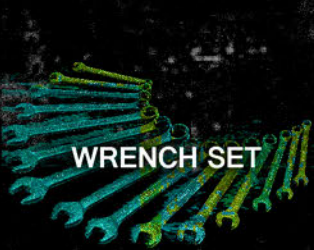

WRENCH SET



ALLEN WRENCHES



SCREWDRIVER SET



SAFETY BITS

Hand tools work in plain sight. Even they can be used to disassemble things or gain access to areas where **APPROVED CRIMINALS** aren't allowed to be. Loosen hand rails, and steal the bolts from bus seats.



CHAINSAW

The electric chainsaw is the most **CRIMINALLY APPROVED** tool of the battery operated saboteur. So silent that arborists often have trouble telling if their peers are making cuts or not. So lightweight that it can be carried by ATV, by hand, or even on a bicycle. The electric chainsaw can drop trees of any size wherever they're needed.

CS GAS

WHEN DEPLOYED AGAINST SOLDIERS IN TIMES OF WAR: WAR CRIME

WHEN DEPLOYED AGAINST CIVILIANS IN TIMES OF "PEACE": BUSINESS-AS-USUAL

EFFECTS

ANYONE CAN BE HURT BY TEAR GAS OR PEPPER SPRAY. PEOPLE AT GREATER RISK OF INJURY OR DEATH INCLUDE THE YOUNG AND OLD, ANYONE WITH ASTHMA, EPILEPSY, A WEAK HEART OR LUNG PROBLEMS.



USE OF PROTECTIVE GEAR IS RECOMMENDED TO MITIGATE EFFECTS

- PANIC
- BURNING EYES
- PAINFUL NOSE
- VOMIT
- SORE THROAT
- TIGHT CHEST
- HEART ATTACK
- SHORT BREATH
- STOMACH ACHES
- DIARRHEA

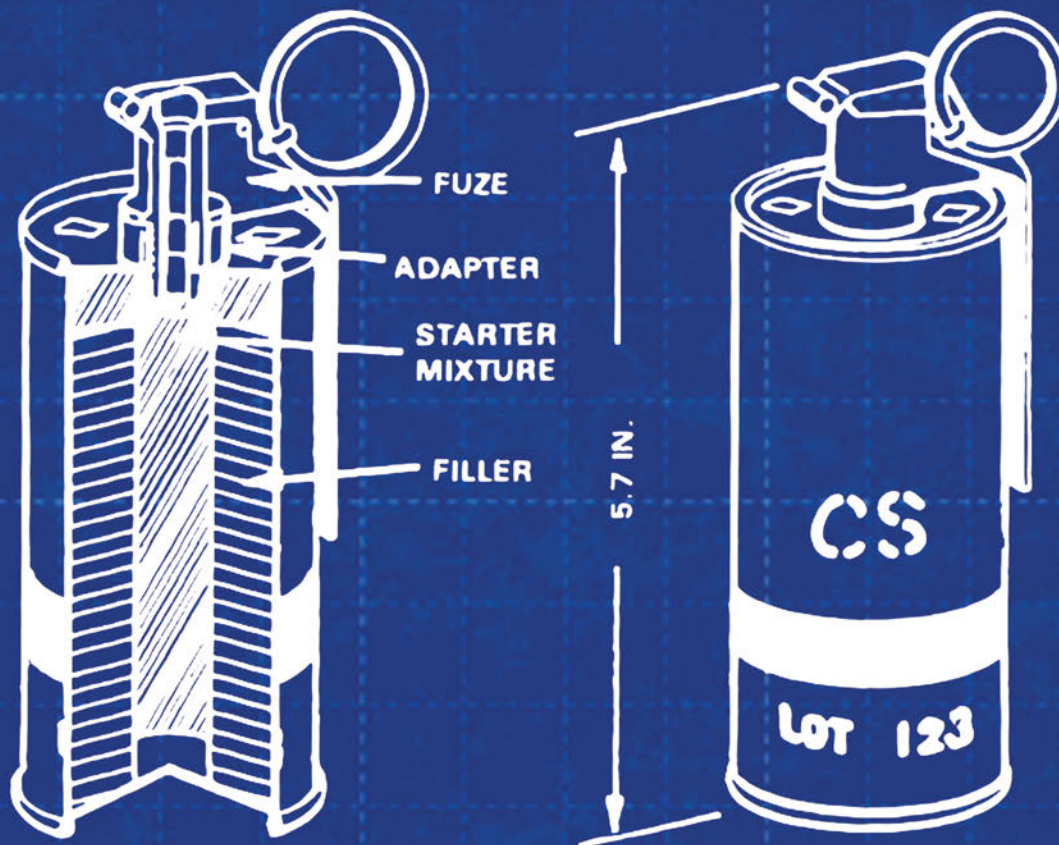

THE HARD RESET: FUCK COPS

"Without cops, these degenerates and niggers would be running amok everywhere"

No... Without the cops, the decision of what to be done about them is truly on you, it's in your hands. Without cops, dealing with the degenerate is a decision forced on the individual, and imparts a mindset and skillset above calling the cops to deal with the issue for you every time there's someone digging in your garbage or threatening to bust your windows over a neighbourly dispute.

Cops maintain the order and preserve the lawlessness degeneracy by scooping the worst of it off the top and creating the impression that the scene has been improved, cops maintain the ability for degenerates to exist by ensuring they're never truly obliterated by yourself or your peers.

No... Simply put, cops interrupt Natural Order by stopping you from taking things in to your own hands.

Cops don't protect us from them, cops protect them from us. From those willing to make the decision and action to make a difference in their communities.

Cops prevent a real food chain and natural selection from forming where the most fit and willing to enact violence can deal with those that have shown themselves as a problem.

Cops, like welfare, create an atrophy in the ability of the people to control their own destiny.

Welfare makes you lazy. Cops make you weak. Simple as.



THE HARD
RESET
THE HARD
RESET
THE HARD
RESET
THE HARD
RESET

Myself, My Mind [04.08.21 22:14]
bring anxiety and spiritual pain to
the enemy with every step you take

Myself, My Mind [04.08.21 22:15]
every step forward you make is more
ground gained for the accelerationist
struggle

Myself, My Mind [05.08.21 02:14]
walk among the pines as a man
among them

soon we will be able to tell them only
of our victories

**PATH
TO
CLOSURE**

HARD

RESET

EMPATHY

Overcoming empathy is
part of growing up:

Empathy for the animal
you must slaughter to eat

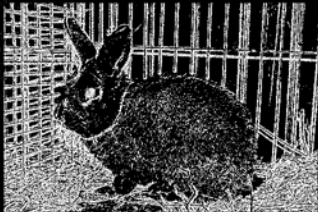

Empathy for the enemy
you must slay to survive



Real moral empathy isn't feeling bad or sorry for the drug addicts that need to be peeled off the sidewalks of your city every morning, real moral empathy is looking out for fellow Whites and lending them a hand when they both need and deserve it.

If someone has a gay bumper sticker, cut them off. Better yet, ride beside them when they're on the highway on-ramp so they're forced to literally stop on the on-ramp. Speed off laughing. No empathy for the accident they might find themselves in.

Procure animals to feed yourself with, when they've lived long enough, schedule their death by your own hands. Your empathy for them should only extend to their living conditions and the humane way you end those living conditions.

But if you're well off financially and your waitress is a young White woman, you better be tipping. All the empathy for someone seen by semites as service cattle.

The point of this passage, though, is that you the reader should have no 'icky sad feelings' about slaughtering animals, or killing our enemies. You won't throw up out of disgust like some hollywood movie when you kill someone for the first time, so long as you kill the right person. Burn their homes down when it's proper, and don't look back.



ANONYMOUS_BOMBER

Not too long from now, a bomb will explode, and I'm the only one who knows its target. I'm also the only one who knows the payload, the type of shrapnel, the detonation system, the concealment method, as well as the way it gets into the kill zone.

It's not so hard, you know. I started small, practiced common sense, saw what worked for me. No need to tell anyone else - it's a one man operation.

Good luck catching me. Literally anyone could do this. I could be a random janitor in the background, a professional off the clock, a middle school student with too much time on his hands.

I could be you.
More importantly, you could be me.

TATP

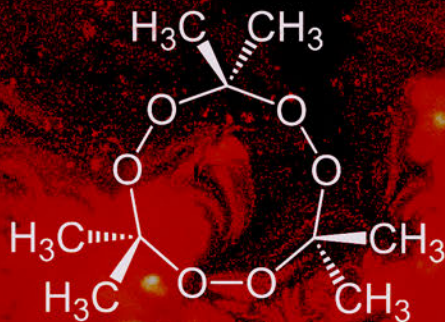

THE GREAT
BALANCING
MOLECULE

KNO₃

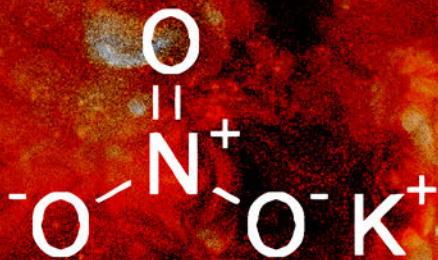

THE GREAT
PROVIDING
MOLECULE

RDX

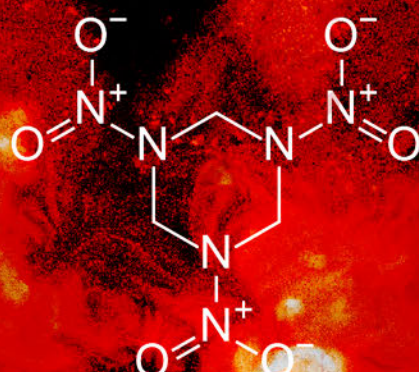

THE GREAT
REMOVING
MOLECULE

CHEMISTRY IS JUST ONE WEAPON TO BE EMPLOYED AGAINST JEWISH ELITISTS.

I FUCKING LOVE SCIENCE

△ THE HARD RESET △ WHISKEY △ PAGE 70 △

I FUCKING LOVE SCIENCE. AND UNLIKE THE SOY-CONSOOMING, QUADRUPLE-VAXXED REDDITORS WHO SO LOUDLY AND OBNOXIOUSLY PROCLAIM THIS, I REALLY MEAN IT.

I FUCKING LOVE RENTAL TRUCKS FULL OF AMMONIUM NITRATE FERTILIZER DETONATING OUTSIDE FEDERAL BUILDINGS.

I FUCKING LOVE RICIN EXTRACTED FROM CASTOR BEANS AND ANTHRAX SPORES CULTIVATED IN CLANDESTINE LABS.

I FUCKING LOVE BALLISTICS THAT MAKE LONG-RANGE HEADSHOTS OF HIGH VALUE TARGETS A REALITY.

I FUCKING LOVE HOMEMADE NAPALM, FLAMETHROWERS AND FIREBOMBS BURNING ELECTED OFFICIALS AND THEIR FAMILIES TO DEATH AND REDUCING THEIR ILL-GOTTEN MANSIONS TO ASHES.

I FUCKING LOVE MODEL ROCKET COMPONENTS, DRONES, RC FUEL AND PYROTECHNIC SUPPLIES USED FOR A HIGHER PURPOSE THAN THEIR RESPECTIVE HOBBIES.

I FUCKING LOVE 3D PRINTED GUNS, SUPPRESSORS, MORTARS, GRENADES AND PROJECTILES.

I FUCKING LOVE ANFO, ANNM, TATP, HMTD, TNT, EGDN AND C-4.

I FUCKING LOVE INDUSTRIAL SABOTAGE, DERAILING TRAINS AND DESTROYING ELECTRICAL SUBSTATIONS.

I FUCKING LOVE SULFURIC ACID MELTING THE FLESH OFF 'RACE TRAITORS' FACES.

I FUCKING LOVE RDDS DETONATING IN OVERPOPULATED CITIES, COSTING THE SYSTEM BILLIONS IN LOST REVENUE AND DECONTAMINATION.

I FUCKING LOVE SIGNAL JAMMERS DELAYING EMERGENCY RESPONDERS UNTIL A LONE WOLF COMPLETES HIS MISSION.



EMPTY THREATS

-THE HARD RESET-

-WHISKEY-71-

Oh, someone's making bomb threats against nigger colleges? That's a gayop at worst; cringe at best.

PRO TIP: If you want to bomb a target, and you want to be successful, don't tip them off ahead of time.

PIPE HAND GRENADE

Hand grenades can be made from a piece of iron pipe. The filler can be plastic or granular military explosive, improved explosive, or propellant from shotgun or small arms ammunition.

MATERIAL REQUIRED

Iron pipe, threaded ends, 1 1/2" to 3" diam., 3" to 8" long.
Two (2) iron pipe caps.
Explosive or propellant
Nonelectric blasting cap.
(Commercial or military)
Fuse cord
Hand drill
Pliers



PROCEDURE

1. Place blasting cap on one end of fuse cord and crimp with pliers.

NOTE: To find out how long fuse cord should be, check time it takes a known length to burn. If 12 inches burns in 15 seconds, a 6-inch cord will ignite the grenade in 15 seconds.

2. Screw pipe cap to one end of pipe. Place fuse cord into pipe. Push blasting cap into the opposite end of the pipe so that the blasting cap is in the center of the pipe.

NOTE: If plastic explosive is used, fill pipe before screwing on blasting cap. Push a rod into the center of the pipe, make a hole and then insert the blasting cap.

3. Pour explosive or propellant into pipe a little bit at a time. Tap the base of the pipe frequently to settle the filler.

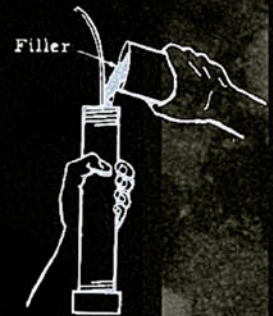

center of the pipe large enough for the blasting cap to go through.



L USE ONLY

Any psychological terror inflicted by a bomb threat is fleeting - quickly offset by beefed up 24/7 security, changes in protocol, and various other countermeasures.

Suddenly, your would-be victims are on high alert; no longer comfortable gathering en masse, where they can be killed easily. Suddenly, the element of surprise - a **CRUCIAL** factor in mass casualty events - is lost. Suddenly, your otherwise soft target isn't so soft.

In effect, threats do more to harden targets than damage them. It's counterproductive - not just for you, but for any madder lads with bigger nads out there who might actually **DO** the things you merely **TALKED ABOUT**.

Or what if you attempted to make good on your threat, and actually carry it out? What is left to attack after a threat is made? After hypervigilant bodies vacate the premissis? All that's left behind is property. No one sets out to cause maximum property damage; maximum body counts are all that matter.

ACTION is necessary when words aren't enough.
VIOLENCE is the answer when diplomacy fails.

By the time bombings are needed to solve a problem, words are meaningless. When words have no meaning, threats are empty. **ALL** threats are empty.

Only make bomb threats when doing so will provide a tactical advantage and enable your actual attack, namely when:

- A) The threat diverts System resources **AWAY** from your actual target location, or
- B) The threat lures System resources **TO** your actual target location (ambush)

But making threats for the sake of making threats is cringe. Don't be a faggot. If you're ready for action but not ready to make an impact, you're not ready. Keep radicalizing, and keep your fucking mouth shut.

You'll get there, but now is **NOT** your time.



GETTING AWAY

WITH IT

IS EASY
HARD RESET ZULU

Y THE HARD RESET Y

THE ONLY THING — HOTEL

THE ONLY THING BETWEEN YOU AND PEOPLE LIKE NANCY PELOSI AT THIS VERY MOMENT, IS SOME WHITE PIG WHO DOESN'T SEEM TO SEE THE WEIGHT OF THE SITUATION YET.





Why should we worry about a knock on the door from the feds? They should be the ones worrying about us. What prevention can there be against a seemingly ordinary person suddenly drawing a gun and

executing an agent

wherever he may find himself at any given moment? They wear uniforms a lot, we spend all of our time out and about wearing plain clothes.

Only a few of them have to die in order for all of us to get some relief.

THE HARD RESET
DEMOCRACY IS A TIKTOK CHALLENGE.

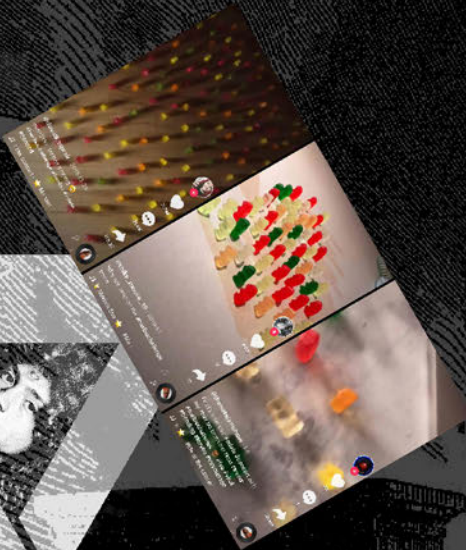

Democracy is a western shitshow of liberals arguing just how liberal things should really be (and how much money should be set aside for israel and the niggers in africa each year.) A facade, a ruse, a lie.

Democracy is a passing fad, something practiced for 1% of the entirety of human history and experience. Those with the will to power will obtain it - if they're strong enough.

GOD BLESS AMERICA

AFGHANISTAN

CONGO

BOSNIA

CHINA

CAMBODIA

EL SALVADOR

DOMINICAN REPUB.

INDONESIA

GRENADA

GERMANY

GUATEMALA

LIBYA

NICARAGUA

IRAQ

IRAN

PANAMA

VIETNAM

SOMALIA

SUDAN

PERU

KOREA

LEBANON

KUWAIT

JAPAN

SYRIA

LAOS

PISS BE UPON THE
WESTERN WORLD



We've talked about cops plenty. Let's shift focus onto the other side - the criminals. I don't mean the hordes of niggers who chimp out. I mean specifically the cream of the crop, the men-of-the-people who single out the System specifically, the objects of fascination and romanticization, the Robin Hoods of history.

They don't break the law out of convenience or personal gain, they do so out of obligation to their folk. They follow a higher calling than the rest of us. Whatever it is - tax evasion, theft, even murder - they do it because someone has to be the instrument of God's will.

No wonder the pigs are terrified to confront them. Their fear comes from their feelings of inferiority and their unwillingness to act comes from their tendency to defer to higher authority, the kind commanded by a man unafraid of the so-called law.



SYSTEM GUILT

YOU'RE TELLING ME I'M GUILTY OF A HATE CRIME?

STRANGE, I DON'T FEEL GUILTY.

IGNORE STATE MORALITY, IT'S JEWISH TO THE CORE AND IT'S INTENDED PURPOSE ISN'T TO ACTUALLY PREVENT LITERAL CRIME, BUT TO STOP YOU FROM GETTING AWAY FROM THINGS THEY VIEW AS CRIME.

YOU ALWAYS HEAR ABOUT THE GUY WHO KILLED ONE OR TWO OF HIS NEIGHBORS FOR A MORE-THAN-JUSTIFIED REASON, AND WHO COULD HAVE GOTTEN AWAY WITH IT, BUT WHO TURNS HIMSELF IN BECAUSE OF THE GUILT HE FEELS.

THERE'S THIS PERPETUALLY PASSED AROUND FALSEHOOD THAT, SOMEHOW, BY GOING TO PRISON TO ROT IN THE HUMID, STINKING DUNGEONS OF THE SYSTEM, AND BY WAKING UP WITH ROACHES ALL OVER YOUR SKIN EVERY MORNING FOR THE REST OF YOUR LIFE, THAT YOU WILL BE SOMEHOW ABSOLVED OF GUILT. THE SYSTEM MAY EVEN EXECUTE YOU, BUT ANY GUILT YOU FEEL ALL THE WAY UNTIL THEY PUT YOU IN THE CHAIR IS A RESULT OF YOU IMPOSING THEIR FALSE STATE MORALITY ON TO YOUR OWN SHOULDERS TO BEAR.

WHEN YOU KILL, IF YOU'RE READY, AND THE KILLING IS RIGHT, YOU'LL FEEL NOTHING BUT EASE AND PEACE OF MIND.

79



"THE HARD RESET"
"SYSTEM GUILT"

XXX
XXX

"GOLF"

AN ARCHIVE OF ACCELERATIONIST THOUGHT
RETURNING NATURAL ORDER

X X

THE HARD RESET **RUIN THE WORLD**

**SHOOT EMERGENCY
FLARES WHERE THERE ARE
NO EMERGENCIES.**

**AMBUSH COPS IN THEIR
CARS WHILE THEY WAIT IN
THEIR SPEED TRAPS.**

**BECOME A PESTILENCE ON
THE SYSTEM, ONE
WITHOUT MORALITY OR
ETHIC TOWARD IT'S
SUBORDINATES.**

HOTEL

AGAINST THE
MODERN WORLD
AND THOSE WHO
DWELL WITHIN IT

AGAINST THE
MODERN WORLD
AND THOSE WHO
DWELL WITHIN IT

AGAINST THE
MODERN WORLD
AND THOSE WHO
DWELL WITHIN IT

AGAINST THE
MODERN WORLD
AND THOSE WHO
DWELL WITHIN IT



NEEDLE IN A HAYSTACK

Remember - they never found those guys who took potshots at FBI agents in their field office during the Eric Rudolph manhunt.

HEARD RESET



**THE LAST THINGS OUR
OPPOSITION SHOULD BE ALLOWED
TO HEAR,**



**ARE ROUGH
BOOT STEPS
ON WET
PAVEMENT**

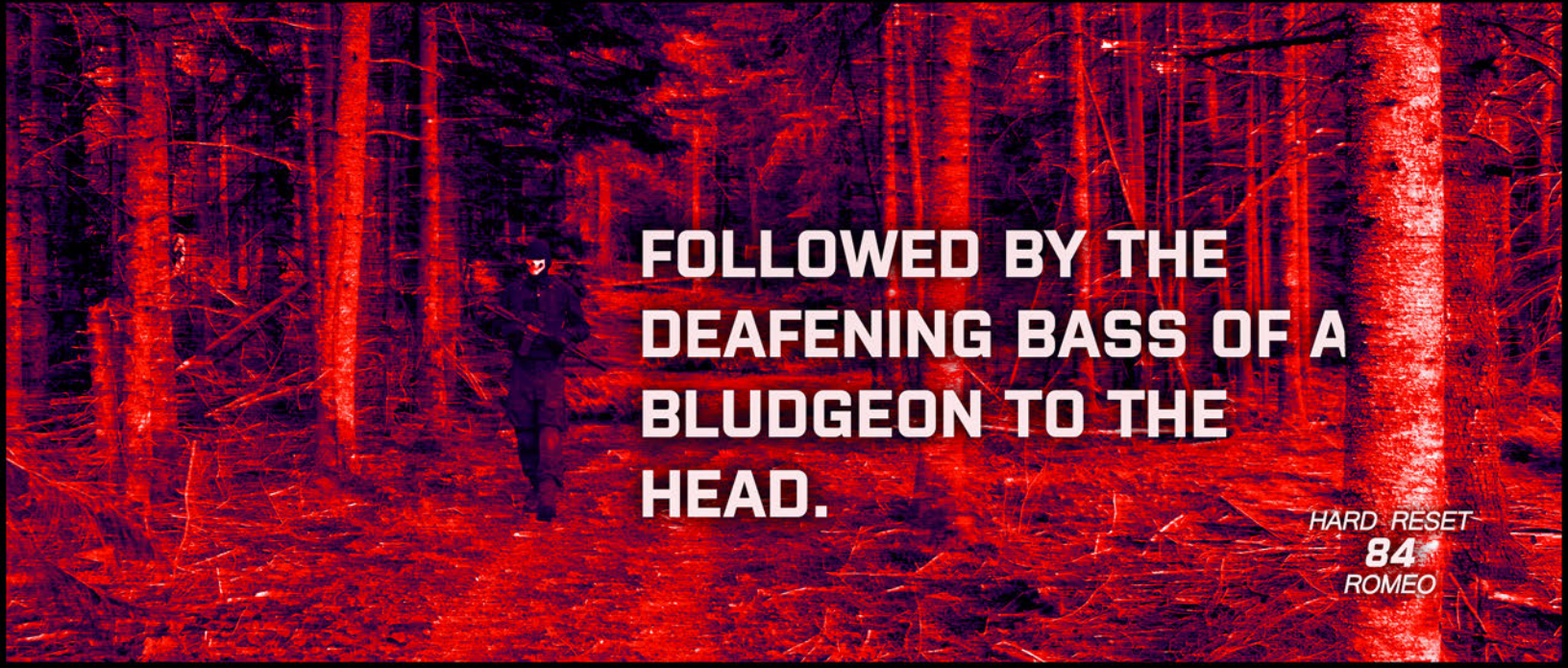

**FOLLOWED BY THE
DEAFENING BASS OF A
BLUDGEON TO THE
HEAD.**

HARD RESET
84
ROMEO

DECLARATION III

BACK TOWARD A HOME YOU NO LONGER RECOGNIZE, YOU STOP AND PONDER;
"I WOULD, NOW, AT THIS POINT, CONSUME MY ENEMY'S HEART"

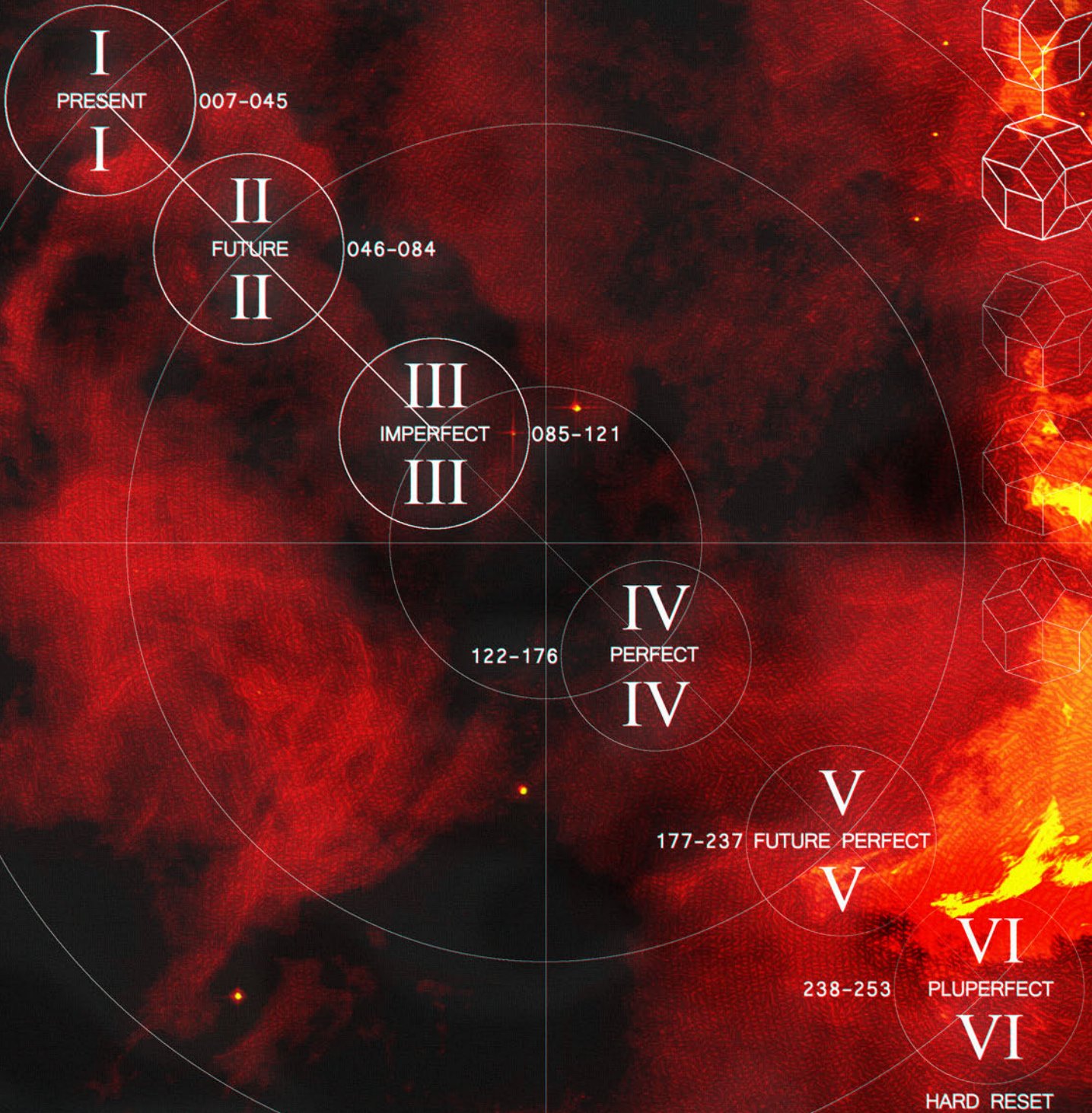

DECLARATION III INFORMATION
GOLF - 1 PASSAGE
HOTEL - 2 PASSAGES
OSCAR - 3 PASSAGES
TOTAL - 6 PASSAGES
37 PAGES

MARKED FOR DESTRUCTION

THE HARD RESET

OSCAR



We are a people marked for destruction. The enemy's agenda is our demise as a great people and slow decline in humiliating servitude.

MILITANT ACCELERATIONISM

They want us to waste away, not to make our heroic final stand. They don't want you to have a struggle that would give your life meaning.

Tough shit – White people have beaten worse odds and we've never been known to go down without a fight.

People love regurgitating propaganda about the late Roman Empire without mentioning the hundreds of thousands of invaders cut down by ever-shrinking Roman legions. Attila the Hun, believed to be invincible, retreated with his tail between his legs out of Gaul when confronted by the Roman armies.

Constantinople likewise suffered a long, drawn-out collapse, avoiding certain doom numerous times before its ultimate demise. Even when the roaches started pouring through the cracks in the thousand-year-old walls and all was lost, the last emperor demonstrated that surrender was out of the question by sacrificing himself rather than beg at the subhuman's feet.

Ten-year-olds gave their lives in the last-ditch defense of Berlin. I would be doing them a disservice by only talking about our people's defeats.

When Visigothic Spain had the gates to its capital thrown open by jew "converts" to be taken over by the arabs, all seemed lost for a disorganized Europe. Yet years before the first big victory was won over the mudslimes, a successful guerrilla campaign in the northern mountains sowed the seeds of the reconquista that would take 800 years to cleanse the peninsula of foreign invaders.

The Balkans had been written off to the roaches even before Constantinople fell, yet what was lost in centuries was regained in decades and the White man became master of his own fate once more. Don't despair. We've been through worse and we'll once more enter a golden age that will make our race's previous accomplish look puny in comparison.



**OSCAR
MARKED FOR DESTRUCTION, 087**

HARD RESET

GOLF

INFRASTRUCTURE NIGGAS



PAGE 89

A QUICK GUIDE...

ON SOME OF THE THINGS THEY DON'T WANT YOU KNOW ABOUT

TRAINS AND TRACKS: 90-93
CELL TOWERS: 94-96
TRUCKS AND DEPOTS: 97-99
ROADS, BRIDGES, AND HIGHWAYS: 100-102
WATER TREATMENT AND DISTRIBUTION: 103-105
COMMERCIAL BUSINESSES: 106-109
COMMUNICATIONS: 110-111
ELECTRICAL: 112-115
HVAC: 116-117
WHO I AM: 118

TRAINS AND TRACKS

THEIR JUNCTION BOXES, ASSEMBLY, SWITCH POINTS, AND MOST SENSITIVE COMPONENTS

01

HISTORY

HISTORICALLY, TRAIN DERAILINGS, WHETHER ACCIDENTAL, OR ON PURPOSE, HAVE CAUSED A GREAT DEAL OF DEATH AND DAMAGE TO THE SECTORS WHICH RELY ON IT.

SOMETIMES DERAILING HAS BEEN CAUSED BY TRACKS WHICH WEREN'T BEING INSPECTED OR MAINTAINED. EXAMPLE: A CRUDE OIL TRAIN TRAVELLING THROUGH QUEBEC IN 2018 KILLED 47 AT A NEAR-BY BAR, AND CAUSED 2000 MORE TO EVACUATE THE AREA.

OTHER TIMES, DERAILMENT HAS BEEN ON-PURPOSE, DIRECTED WITH REASON AND TYPICALLY WITH ENVIRONMENTAL INTENTIONS.

ASIDE FROM DEATH, THIS TYPE OF SABOTAGE HAS HUGE POTENTIAL OF ECONOMIC RAMIFICATIONS, CAUSING DELAYS, AND IMPOSING TERROR TOWARD CORPORATE ENTITIES INVOLVED IN THIS INDUSTRY.

IMPACT

A STRIKE AGAINST ANY TARGET WILL HAVE TWO TYPES OF IMPACT:

1. THE SUFFERING YOUR TARGET WILL WITHSTAND, INCLUDING THE COST ASSOCIATED WITH RESTORING ITSELF.
2. THE HEIGHTENED SECURITY ON THE LOCAL AND NATIONAL LEVEL IN REACTION TO THE DEMONSTRATABLE DAMAGE THAT CAN BE DONE TOWARD THIS TARGET.

THE FORMER IS SIMPLE AND CALCULATABLE BASED ON THE TYPE OF ACTION TAKEN (SEE: PROCEDURES), BUT THE LATTER WILL DEPEND ON MANY VARIABLES INCLUDING IF YOU BELONG TO THE EAST OR WEST, YOUR COUNTRY'S ECONOMIC ABILITIES, AND THE STATE OF CHAOS YOUR NATION MAY BE IN DURING OR AFTER YOUR ATTACK.

AN ATTACK AGAINST THIS TARGET WILL HEIGHTEN SECURITY, BUT IT'S IMPOSSIBLE TO COVER EVERYTHING, THERE WILL ALWAYS BE GAPS IN THE ENEMY'S SHIELDS.

CONSIDERATIONS

IN DEVELOPED NATIONS, TRAINS ARE BEING SURVEILLED TO A GREAT DEGREE; IN PARTICULAR THE SECURITY AROUND BORDERS IS HEIGHTENED AND SEVERAL TECHNOLOGIES SHOULD BE EXPECTED IN ADDITION TO THE MANPOWER SURROUNDING THE TRAINS AND THEIR TRACKS.

IS THE RAIL COMPANY UTILIZING DRONES TO WATCH THEIR TRAINS?

ARE THERE CAMERAS? AND IF SO, ARE THOSE CAMERAS OUTFITTED WITH INFRARED OR THERMAL ABILITIES?

IS THE AREA YOU SEEK TO AFFECT SURROUNDED BY FENCING, BARRIERS, AND/OR GATES?

ARE THERE GUARDS PLACED IN THE AREA? DO THEY HAVE DOGS WITH THEM? MAYBE FIREARMS?

WHAT IS THE LOCAL POLICE RESPONSE TIME?

IS THE AREA ACCESSIBLE BY FOOT ONLY, OR CAN YOU UTILIZE AN ORDINARY, OR OFF-ROAD VEHICLE TO ACCESS IT?

THE NOISE/LIGHT PRODUCED BY SOME OF THE FOLLOWING METHODS.

TRAINS AND TRACKS

PAGE 2

PROCEDURES (JUNCTIONS):

JUNCTION BOXES HAVE LONG BEEN A TARGET HIT BY ANARCHIST AND ECO-ORIENTED GROUPS IN WESTERN EUROPE FOR THEIR EASE AND RESULTING JAMMING UP OF THE DAY FOR EVERYONE RELIANT ON THE TRAINS. JUNCTION BOXES ARE EASILY OPENED, AND EASILY DESTROYED. FIRE, OR DESTRUCTION BY MECHANICAL MEANS ARE IDEAL.

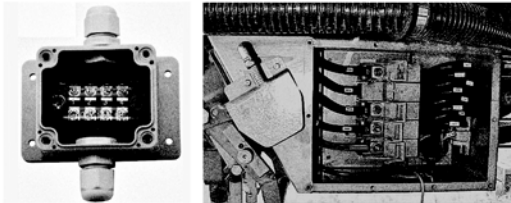
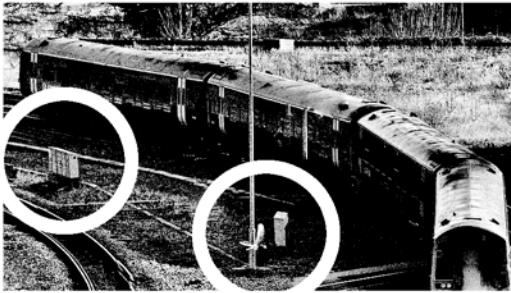

LIDS/DOORS OF THE JUNCTION BOXES CAN BE REMOVED BY PHYSICAL FORCE AND TOOL. SOME UTILIZE PAD LOCKS OR BARREL LOCKS.

THE INSIDE OF THE BOXES ARE THE BRAINS OF A JUNCTION, AND ARE VERY PHYSICALLY WEAK.

THE LIVE WIRES INSIDE CAN BE CUT (WHILE WEARING THICK RUBBER INSULATED GLOVES, AND WHILE USING RUBBER INSULATED TOOLS).

SET SCREWS HOLDING THE WIRES IN PLACE CAN ALSO BE BACKED OFF SLIGHTLY TO CREATE POOR CONNECTIONS (WHILE USING A SCREWDRIVER WITH AN INSULATED HANDLE AND NEVER TOUCHING THE STEEL PART OF THE DRIVER).

IF THE BOX IS PRESENT IN A RURAL AREA, IT OFTEN HAS A BRIGHT LED

WHITE LIGHT PRESENT ON THE SIDE FACING ANY NEARBY ROADS, OR A SERIES OF LOW-BRIGHTNESS LIGHTS PRESENT AS AN INTERFACE.

PROCEDURES(TRACKS): TRACKS ARE LARGELY UNGUARDED, PAN A LARGE AREA, ARE REQUIRED TO BE IN GOOD CONDITION TO WORK, AND ARE THUS SUSCEPTIBLE TO A HUGE HOST OF ATTACK METHODS.

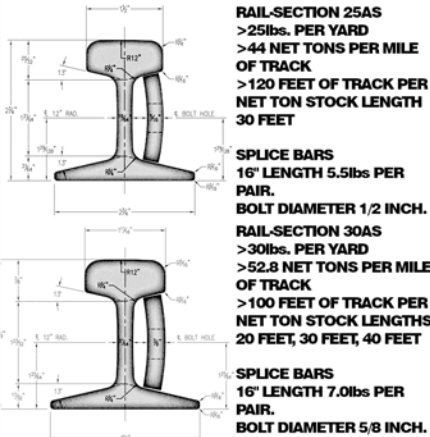

FAMILIARIZATION WITH TRACK TYPES AND LOCATIONS FOR YOUR COUNTRY ARE IMPORTANT IF YOU HOPE TO STRIKE LONG-DISTANCE HAULING TRACK. USE A VPN AND PROTECT YOURSELF IN AS MANY WAYS AS POSSIBLE WHILE RESEARCHING THESE TOPICS. MIND CHOKE POINTS.

MAPS OF ANY REGION'S RAILS AND JUNCTIONS CAN BE FOUND EASILY THROUGH GOOGLE MAPS, APPLE MAPS, OPENSTREETMAPS, ETC. IF THE SABOTEUR SO DESIRES, A PERSONAL GPS DEVICE CAN BE PRE-LOADED FOR EASY NAVIGATION AND LOCATION FINDING FOR TRACKS, AS WELL AS MAPPING OUT WHERE EACH TRACK INEVITABLY LEADS

WITHIN HIS OR HER OWN COUNTRY. (BUT NEVER, OF COURSE, RELY ON A CELLPHONE OR CARRY A CELLPHONE WITH YOU ON SUCH OPERATIONS).

TRACK SABOTAGE TECHNIQUES OFTEN CONSIDERED INCLUDE: BURNING, DIGGING UP, DISASSEMBLY, MELTING, BLOCKING, AND MODIFYING FOR DERAILMENT.

BURNING
BURNING IS A TECHNIQUE OFTEN DISCUSSED BUT NOT EMPLOYED. THE TIES THEMSELVES ARE FLAME-RETARDANT IN MOST CASES AND THIS TECHNIQUE WILL NOT OFFER THE RESULTS DESIRED. TRACKS ARE EVEN LIT ABLAZE INTENTIONALLY BY WORKERS IN ORDER TO PREVENT TRACK FREEZING AND THE ACCOMPANIED DELAYS. AS IMAGED BELOW



DIGGING UP
REMOVAL OF ALL SURROUNDING CINDERS, SOIL, AND ROCKS FROM AROUND TRACKS AND THEIR TIES CAN THE RAILS THEMSELVES TO ACURIE DAMAGE, LEADING TO A DERAILMENT. THIS IS PARTICULARLY EFFECTIVE WHEN DONE IN TANDEM WITH THE NEXT METHOD.

DISASSEMBLY
THE REMOVAL OF FISH-PLATES WHICH EXIST TO ATTACH RUNS OF RAIL TOGETHER, THE REMOVAL OF TIE-PLATES WHICH ATTACH THE RAILS TO THE TIES, AND THE REMOVAL OF RAIL SPIKES WHICH ATTACH THE RAIL TO THE TIES ALL CONSTITUTE EFFECTIVE DISASSEMBLY OF TRACKS, AND WHEN

TRAINS AND TRACKS

PAGE 3

TRACKS, CONTINUED:

DONE ALL AT THE SAME TIME OR IN ACCORDANCE WITH DIGGING UP THE RAILS AND TIES, THE SABOTEUR CAN BE SURE HE OR SHE HAS ENSURED DESTRUCTION. A FISH PLATE AND SPIKE ARE PICTURED BELOW.

NOTE THAT THE FISHPLATES ARE SOMETIMES WELDED TO THE TRACKS.

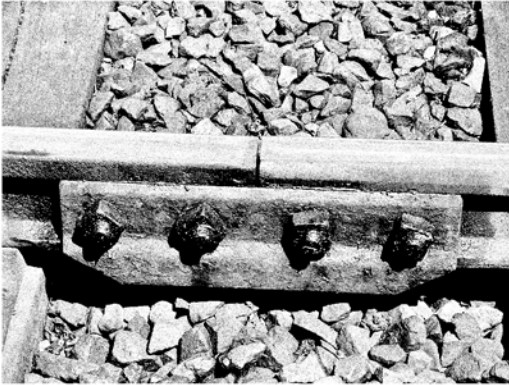

MELTING THERMITE IS A SIMPLE TOOL THAT EVERY SABOTEUR SHOULD BE CAPABLE OF MAKING WHETHER THEY HAVE ACCESS TO ADVANCED TOOLS AND MATERIALS OR NOT.

SIMPLE IRON OXIDE BASED THERMITE BURNS AT OVER 4000 DEGREES FAHRENHEIT, WHICH IS MORE THAN ENOUGH TO DEFORM AND CUT THROUGH THE TRACKS, CAUSING IMMEDIATE ISSUES FOR THE NEXT TRAIN TO CROSS OVER IT.



BLOCKING BLOCKADES CAN BE CONSTRUCTED UPON TRACKS, PREVENTING TRAINS FROM SAFELY MOVING THROUGH THEM. HEAVY METAL BARS OR EXTRUSIONS CAN BE LAID ACROSS THE TRACKS, RAIL TO RAIL FOR A LESS DETECTABLE BUT EQUALLY EFFECTIVE SABOTAGE.



OTHER MODIFICATIONS FOR THE DESIRE OF DERAILMENT THE PLACEMENT OF STEEL SHIMS, BARS, ROCKS, OR BY POURING CONCRETE INSIDE OF RAILROAD SWITCHES CAN CAUSE NOT ONLY DERAILMENT, BUT ALSO HEAD ON COLLISIONS WHERE THERE COULD BE OTHER TRAINS PRESENT.

RAILROAD SWITCHES OFTEN UTILIZE GAS OR ELECTRIC HEATERS IN THE WINTER TO AVOIDING SWITCHING PROBLEMS CAUSED BY SNOW OR ICE. THEY CAN BE EASILY DAMAGED OR EVEN SIMPLY TURNED OFF DURING OPPORTUNE TIMES, SUCH AS DURING SNOW STORMS.

PLACEMENT OF THICK STEEL AIRCRAFT CABLE ALONG THE

TRACKS IS ANOTHER TECHNIQUE WHICH CAN BE EMPLOYED, LEADING TO THE TRAIN BEING DERAILED, OR COMPLETELY BOUND UP IN CABLE.

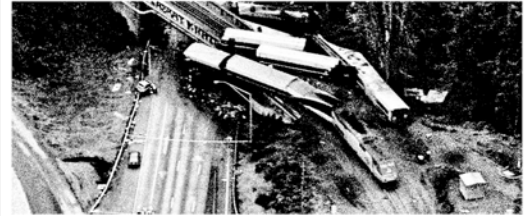

PROCEDURES (TRAINS):

TRAINS THEMSELVES ARE NOT DISCLUDED FROM SABOTAGE.

THE BRAKES OF TRAINS SHOULD BE CONSIDERED MORE THAN ANY OTHER PORTION OF THE TRAIN. MOST TRAINS EITHER USE AIR BRAKES, OR PNEUMATIC BRAKES.

AIR BRAKES ARE DRIVEN BY A COMPRESSOR WHICH EXTENDS A CYLINDER, APPLYING THE PRESSURE OF PADS ON TO A DISC.

PNEUMATIC BRAKES WORK IN THE SAME WAY BUT WHILE ALSO UTILIZING ELECTRONICS FOR EFFICIENCY AND EASE OF USE.

THERE ARE AUDIAL ALARMS PRESENT FOR TRAIN OPERATORS TO KNOW WHEN THEIR BRAKES ARE WEARING, BUT NOT WHEN THEY HAVE BEEN DISABLED. THESE SENSITIVE AND EASILY DESTROYABLE COMPONENTS COULD BE HURT IN MANY OF THE SAME WAYS A SABOTEUR COULD ATTACK THE TRACKS THEMSELVES.

ANOTHER SENSITIVE AND EXPOSED COMPONENT IS THE TRAIN CAR COUPLER WHICH ATTACHES EACH CAR TOGETHER.

THERMITE, OR A GOOD SET OF HAND TOOLS WOULD MAKE AN EASY JOB FOR A SABOTEUR WHEN IT COMES TO COUPLERS.

TRAINS AND TRACKS PAGE 4

PROCEDURES (CHOKE POINTS):



A QUICK LOOK IN TO RAIL LOCATIONS SHOWS THAT FROM EAST TO WEST COAST, THE USA AND CANADA SHARE UNDER 20 HAULING GAUGE TRACK CROSSINGS DESPITE CANADA BEING THE USA'S SECOND BIGGEST TRADE PARTNER. 335.3 BILLION USD IN TRADING PER YEAR OCCURS OVER THIS BORDER WITH MUCH OF IT GOING OVER THE TRACKS.

THESE CHOKE POINTS ARE EXTREMELY SENSITIVE AREAS SHOULD A SABOTEUR WANT TO CAUSE REAL AND LONG TERM ECONOMIC DAMAGE TO A REGION.

ALL OF THIS DATA TOOK 30 MINUTES OF RESEARCH TO FIND AND VERIFY. IT CAN BE VERIFIED WITH ANY CITY, COUNTY, STATE, OR COUNTRY IN MIND.

CELL TOWERS

THEIR TYPES, PRICES, LOCATIONS, AND WEAKNESSES

02

HISTORY

EARLY 2020 IN THE WEST MARKED THE EARLY PERIODS OF INDIVIDUALS, YOUNG AND OLD BURNING DOWN THEIR LOCAL 5G TOWERS.

MANY RELIED ON SIMPLY BURNING SOME GAS AT THE BOTOM CONDUITS, BUT MANY OTHERS DEVELOPED AND EMPLOYED MORE ADVANCED METHODS OF ATTACK.

FOOTAGE OF SUCH ATTACKS BEGAN APPEARING EVERYWHERE FROM FACEBOOK TO TELEGRAM SHOWING THE DESTRUCTION OF SUCH TOWERS, EVEN IN BROAD DAYLIGHT AND BY PEOPLE USING THEIR OWN PERSONAL VEHICLES IN SOME CASES.

THIS GENERALLY CONTRIBUTED TO DIRECT ACTION, NOT BY ANY ONE POLITICAL EXTREME, BUT BY ORDINARY PEOPLE TURNED SABOTEURS WHO WERE CONCERNED WITH THE POSSIBLE NEGATIVE EFFECTS OF 5G RADIATION.

CONSIDERATIONS

CELL TOWERS OFTEN HAVE A BARRICADE OF FENCING CONSTRUCTED AROUND THEIR BASE, FROM CONCRETE, STEEL CHAIN-LINK, OR WOODEN BOARDS. SUCH IS THE CASE WHETHER THE TOWER EXISTS IN AN URBAN OR RURAL SETTING. BARBED WIRE AS WELL.

OFTEN, THERE ARE DOME CAMERAS OR OLDER STYLE MONO-DIRECTIONAL CAMERAS INSTALLED 10-15 METERS UP THE TOWER ITSELF. SOMETIMES THERE ARE HIGHER CAMERAS NOT NECESSARILY MOUNTED ON THE TOWER ITSELF. MOTION DETECTORS TOO.

MONOPOLE TOWERS DONT HAVE EXPOSED INSULATORS/WIRES AND WOULD HAVE A HARDER TIME BEING BURNED DOWN FROM THE BOTTOM.

GOING TOO CLOSE TO A TOWER WOULD ALMOST SURELY RESULT IN ONE'S OWN DEVICES CONNECTING TO THE TOWER, BEST NOT TO BRING A PHONE WITH ON ANY SABOTAGE, BUT ESPECIALLY NOT ON THIS ONE.

THE DEVICES AT THE TOP ARE SENSITIVE TO EVEN SMALL CALIBRE FIRE.

IMPACT

-----PRICE-----
AS OF Q1 2021, THE PRICE OF SETTING UP A 5G NETWORK IS BETWEEN USD \$250,000 - \$1,200,000. PEOPLE WHO NEED TO GET PAID INCLUDE MANUFACTURERS, TOWER CREWS, RF ENGINEERS, FIELD ENGINEERS, TRUCK DRIVERS, AND MOST IMPORTANTLY CEOS.

-----SERVICE-----
MINOR DAMAGE TO THE SENSITIVE DEVICES IN THE UPPER PORTIONS OF THE TOWER WOULD RESULT IN THE REQUIREMENT OF TOWER CLIMBERS TO MAKE REPAIRS.

A BURNED OUT TOWER NEEDS TO BE FULLY REPLACED, AND WOULD BE FAR MORE EXPENSIVE, BUT THIS TECHNIQUE IS BECOMING MORE DIFFICUL DUE TO A MODERN APPROACH IN TOWER CONSTRUCTION. SEE CONSIDERATIONS.

-----REACTION-----
AS TOLD IN HISTORY, THIS TYPE OF ACTION ECHOES THROUGH 5G-RESISTANT POPULATIONS AND ALMOST SURELY WOULD IGNITE FURTHER ACTION AGAINST TOWERS. THE TOWERS THEMSELVES ARE HARD TO DEFEND, ESPECIALLY AGAINST RANGED ACTION. TERRIFYING THE TECHNOCRATS WHO LOVE TO INSTALL THEM EVERYWHERE.

CELL TOWERS PAGE 2

CONSIDERATIONS CONT:

ANY ACTION AT THE SCENE WILL RESULT IN AUTHORITIES DOING DEEP SEARCHES OF THE AREA FOR PRINTS, DNA, AND ANY OTHER EVIDENCE YOU MAY LEAVE BY ACCIDENT. ENSURE ALL OF YOUR TOOLS HAVE BEEN CLEANED AND HAVE HAD ANY PRINTS ON THEM REMOVED BEFORE YOU BEGIN SABOTAGE IN THE EVENT THAT A TOOL IS DROPPED OR LEFT BEHIND.

TRY TO ENSURE THAT ALL TOOLS HAVE A PROPER PLACE IN YOUR KIT, SOMEWHERE TO PUT THEM BACK WHEN YOU'RE DONE USING THEM.

IF YOU HAVE KIT WHICH YOU'RE WEARING (LIKE A HEADLAMP, OR ANY BELT-MOUNTED KIT) ENSURE THAT IT HAS STRONG RETENTION AND CANNOT FALL OFF YOU IN THE CASE YOU NEED TO FLEE IN A HURRY.

IF OPERATING AT NIGHT, RED LIGHT IS IDEAL FOR TWO REASONS:
- RED LIGHT DOESN'T HURT YOUR NATURAL NIGHT VISION AS MUCH, ALLOWING YOU TO TURN IT OFF BUT STILL SEE WELL IN THE DARK.
- RED LIGHT DOESN'T TRAVEL AS FAR, MAKING IT HARDER TO DETECT FROM A DISTANCE.

AS A UNIVERSAL RULE ACROSS ALL OF THESE GUIDES, THE LESS LIGHT YOU CAN SAFELY AND EFFECTIVELY OPERATE IN, THE BETTER.

BECAUSE OF SOME TOWERS HAVING ENCLOSED WIRING AND COMPONENTS, YOU MAY NEED TO RESORT TO CLIMBING THE TOWER, THROWING THINGS IN TO THE TOWER, OR UTILIZING POLES TO PLACE AND THEN LIGHT FLAMMABLE MATERIALS IN PARTS OF THE TOWER WHERE THERE ARE EXPOSED WIRING AND COMPONENTS.

THE HEIGHT OF THE TOWER IS A BIG DETERMINING POINT OF WHAT KIND OF ACTION A SABOTEUR CAN SAFELY

TAKE AGAINST A CELL TOWER.

A WINDY OR RAINY NIGHT SHOULD DETERMINE YOUR METHODOLOGY AS WELL, WITH FIRE LEADING TO YOUR EFFORTS BEING FOR NOTHING. BUT ON A STORMY NIGHT, YOU WOULD HAVE GREATER COVERAGE IF YOU CHOOSE TO SHOOT AT THE TOWER.

PRACTICE EXTREME CAUTION AGAINST YOUR OWN INJURY OR DEATH IN THE EVENT YOU CHOOSE TO CLIMB OR BURN THE TOWER.

PROCEDURE (FINDING):

THE SABOTEUR CAN EASILY FIND 5G TOWERS BY USING A CELLULAR MAPPING SERVICE SUCH AS WEBSITES CELLMAPPER, OPENSIGNAL, ANTENNASearch, CELLRECEPTION, SCADACORE, OR BY JUST KNOWING ONE'S OWN AREA AND MAKING NOTE OF TOWERS WHEN ONE SEES THEM.

THE TOWER'S LOCATION AND SURROUNDINGS CAN BE SAFELY VERIFIED USING ONLINE MAP SERVICES AND IN PARTICULAR GOOGLE STREET VIEW. ALWAYS USE A SECURE SYSTEM WITH A VPN TO PROTECT YOURSELF.



SOME SERVICES PROVIDE ADDITIONAL INFO ON TOWERS.

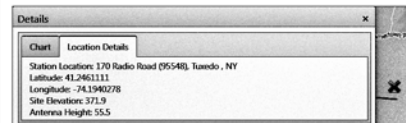

WHEN VERIFYING A TOWER, USE SATTELITE VIEW TO VERIFY IT'S LOCATION, AND THEN STREET VIEW. IF YOU'RE HAVING TROUBLE SEEING THE TOWER, CHANGE THE DATE TO THE WINTER OR AUTUMN MONTHS IN STREET VIEW SO THERE ARE NO LONGER LEAVES ON THE TREES OBSCURING YOUR VIEW.



TOWERS ARE OFTEN PLACED AROUND PUBLIC PARKS, HOSPITALS, SCHOOLS, GOVERNMENT BUILDINGS, AND OTHER CROWDED PLACES.

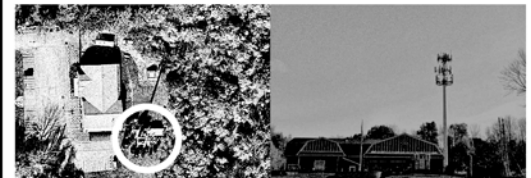

PROCEDURE (SHOOTING):

THE FIRST STEP FOR THE SABOTEUR TO SHOOT AT THE TOWER IS TO KNOW WHAT RANGE HE IS CAPABLE OF SHOOTING AT. FOR EXAMPLE, IF THE SHOOTER IS CAPABLE OF SHOOTING SUPPRESSED .22LR AT 200 YARDS THEN WE DO THE FOLLOWING:

1. TAKE A SCREENSHOT OF THE TARGET AREA, WITH THE TOWER IN THE MIDDLE OF THE FRAME.
2. DRAW A CIRCLE AROUND THE TOWER USING IMAGE MODIFICATION SOFTWARE, WITH THE CIRCLE REPRESENTING A 200 YARD RADIUS/400 YARD DIAMETER.



CELL TOWERS PAGE 3

SHOOTING CONT:

WITH YOUR CREATED IMAGE, YOU NOW HOW A RANGE BUBBLE OF AREAS YOU CAN SHOOT FROM. DETERMINE A SAFE SHOOTING LOCATION WITHIN THIS BUBBLE THAT HIDES YOU FROM DIGITAL SURVELLIENCE AND FROM CURIOUS PASSERSBY.

THE IDEAL WEATHER CONDITIONS ON THE NIGHT OF YOUR SABOTAGE WILL BE STORMY AND WINDY TO DETER PEOPLE FROM BEING OUTSIDE, AND TO LOWER VISIBILITY OF YOURSELF. APPROACH THE TARGET AREA WITHIN A FEW MILES AND PARK YOUR VEHICLE FAR AWAY, NAVIGATE SAFELY TO YOUR DESIRED SHOOTING POSITION BY WAY OF BICYCLE, OFF-ROAD VEHICLE, OR BY FOOT. MAKE SURE YOU'RE STILL CLOSE ENOUGH TO YOUR VEHICLE IF YOU NEED TO MAKE AN ESCAPE.

NOTE THAT DURING THE RESULTING INVESTIGATION, THEY WILL BE ABLE TO DETERMINE THE DIRECTION THE SHOTS CAME FROM AND WILL LIKELY FIND YOUR SHOOTING POSITION, ENSURE YOU LEAVE NO TRACES OF EVIDENCE BEHIND.

THE TARGETTED PORTIONS OF THE TOWER SHOULD BE ANY DISH-LIKE COMPONENT, THE RECTANGULAR VERTICAL 5G PANELS, AND ANYTHING ELSE WHICH APPEARS TO HAVE A COMMUNICATION CAPACITY.

THIS IS AN IDEAL TECHNIQUE SINCE THE SABOTEUR IS PLACED IN THE LEAST AMOUNT OF LEGAL AND PHYSICAL HARM. IT'S LIKELY THAT THE TECHNICIANS WORKING TO MAINTAIN CELLULAR SERVICE WILL NOT EVEN KNOW THE LOSS OF SERVICE WAS DELIBERATE UNTIL THEY CAN INVESTIGATE MORE CLOSELY.

AFTER ESCAPE, THE FIREARM SHOULD EITHER HAVE IT'S BARREL

SWAPPED OUT, CLEANED EXTENSIVELY WITH A BRASS BRUSH, OR SHOT A FEW HUNDRED TIMES IN ORDER TO DEFORM THE RIFLING FROM THE NIGHT THE SABOTAGE TOOK PLACE.

PROCEDURE (BURNING):

1. EXPOSED WIRES/LATTICE TOWERS

IF THE TOWER HAS EXPOSED INSULATED WIRING, OR BOXES CONTAINING WIRING ON THE GROUND LEVEL AS IS COMMON IN LATTICE DESIGNS, THEN THE SABOTEUR CAN EASILY SET THESE ABLAZE WITH ANY LIQUID FUEL, WHICH WILL DISABLE THE TOWER COMPLETELY AND HOPEFULLY ALLOW THE FLAMES TO TRAVEL UPWARD BURNING THE COMPONENTS IN THE TOP OF THE TOWER AS WELL.

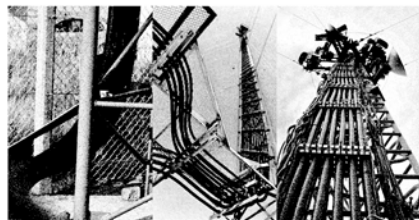

2. ENCASED WIRES/MONOPOLE TOWERS

THINGS ARE MORE COMPLICATED WITH THIS TYPE OF TOWER, BECAUSE THE SABOTEUR CANNOT RELY ON HIS OR HER FLAME TO TRAVEL UP FROM THE BOTTOM OF THE TOWER TO CAUSE ANY REAL DAMAGE.

THE SABOTEUR MUST SATURATE CLOTH SUCH AS TOWELS, OR BED SHEETS WITH GASOLINE AND PLACE THEM IN THE TOWER EITHER BY CLIMBING OR BY UTILIZING A LONG EXTENDABLE POLE. AN UNTESTED IDEA IS USING A DRONE TO DROP A GASOLINE SOAKED BED SHEET ON THE TOP OF THE TOWER AND THEN USING ANOTHER MEANS TO SET IT ABLAZE. THE SABOTEUR CAN THROW A LINE IN TO THE

TOWER AND THEN USE IT AS A PULLEY TO PLACE MATERIALS.

THE SABOTEUR CAN ATTEMPT TO THROW THIN TIRES (SUCH AS FROM A BICYCLE) PACKED WITH GASOLINE SOAKED RAGS ON TO THE TOWER, BEFORE LIGHTING THEM AS WELL.

FINALLY, THE SABOTEUR CAN ATTEMPT TO MOLOTOV COCKTAIL OR OTHERWISE FIREBOMB THE TOWER BY THROWING INCINERARIES UP IN TO IT. PICTURED: MONOPOLE TOWERS

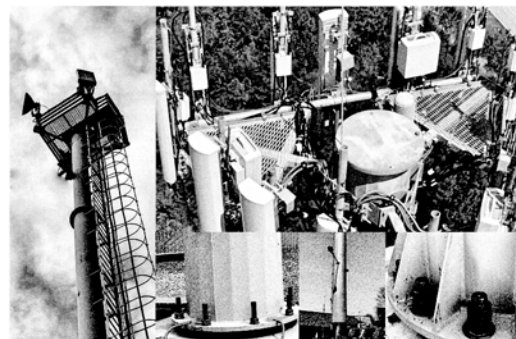

SHOULD YOU DECIDE TO CLIMB THE TOWER, YOU SHOUL BE AWARE OF THE DANGERS TO YOURSELF NOT ONLY FROM FALLING, OR ELECTROCUTION, BUT ALSO FROM ELECTROMAGNETIC ENERGY. ANTENNAS AND TRANSMITTERS THEMSELVES POSE SUCH A DANGER THAT WORKERS ON TOWERS ARE REQUIRED TO WEAR RF MONITORS AND ARE ADVISED NOT TO STAND IN FRONT, STAND NEAR FOR TO LONG, OR TO WORK ON THEM WITHOUT GUARDING. YOU'LL FRY YOUR BRAINS, AND YOUR BALLS/OVARIES.

PROCEDURE (COLLAPSE):

GUYED TOWERS ARE TALL SLIM TOWERS RELYING ON GUY LINES TO RESIST WIND AND OTHER LATERAL LOADS. THE GUY WIRES CAN BE UNSAFELY CUT WITH A CORDLESS

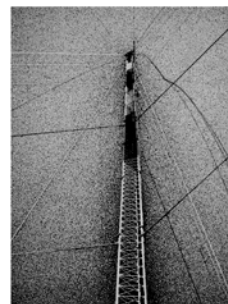

GRINDER. A BETTER SOLUTION WOULD BE TO PLACE TIMED THERMITE CHARGES ON/AROUND THE GUY WIRE BASES WITH ENOUGH TIME FOR THE SABOTEUR TO GET FAR AWAY. THE GUY WIRES ARE UNDER EXTREME TENSION.

TRUCKS AND DEPOTS

SNATCH AWAY THE FUEL NEEDED TO DELIVER PLASTIC GARBAGE

03

HISTORY

THOUGH TRUCK DEPOTS HAVE NOT BEEN A TRADITIONAL TARGET FOR SABOTEURS, THEY ARE GREAT TARGETS FOR THE SABOTEURS OF CONSUMERIST NATIONS WE ALL FIND OURSELVES LIVING IN.

WITHOUT SABOTAGE EVEN OCCURING, THE PEOPLE OF CANADA IN Q1 2022 EXPERIENCED THE THROWS OF TRUCKERS NOT WILLING TO MAKE DELIVERIES WHILE BLOCKING ROADS.

THIS LACK OF TRUCKERS LEAD TO A SHORTAGE OF CONSUMERIST GOODS, AND OF INFRASTRUCTURE-RELIANT GOODS FOR SOME REGIONS OF CANADA WHICH CONTRIBUTED OVERALL TO THE SLOW COLLAPSE THE WEST IS IN.

THOUGH THE HISTORY IS SHORT, YOU CAN HELP EXPAND IT MOVING FORWARD.

IMPACT

AS SHOWN IN THE HISTORY COLUMN, CANADA Q1 2022, THE PREVENTION OR FAILURE OF TRUCKERS TO DELIVER CONSUMER GOODS CAN HAMPER AND ANGER A HOST NATION'S GOVERNMENT AND POPULATION.

IN AREAS WHERE PIPELINES OR RAILWAYS HAVE NOT YET BEEN DEVELOPED TO DELIVER FUEL, A DISRUPTION OF TRUCK-DELIVERED FUEL CAN BRING A HOST OF STOPPAGES IN THE EVERYDAY DUTIES AND ACTIONS OF REGIONS.

TRUCK DEPOTS ARE A PARTICULARLY SENSITIVE PART OF ENSURING TRUCKERS CAN MAINTAIN THEIR RIGS, AND SAFELY HAVE A REST BEFORE CONTINUING THEIR JOURNIES, MEANING DEPOTS ARE AN IDEAL PLACE TO CAUSE UNWANTED DISRUPTION IN THIS SECTOR DUE TO EASE AND IMPORTANCE.

CONSIDERATIONS

---PRESENCE OF PEOPLE--- STOPS ARE CRAWLING WITH PEOPLE. DRIVERS, EMPLOYEES, AND SECURITY ARE ALL OVER THE PLACE. WALKING ABOUT, EATING, SLEEPING IN THEIR TRUCKS, FUELING UP, SMOKING CIGARETTES, AND SO ON.

---PRESENCE OF TECHNOLOGY--- SECURITY CAMERAS, A USUAL DETERRENT IN SABOTAGE ARE NOW SUPPLEMENTED BY DASHCAMS PRESENT IN MOST TRUCKS.

TRUCK DEPOTS ARE ALSO EXTREMELY WELL LIT WITH TALL WHITE LED TOWERS LITTERING THE AREA.

---PRESENCE OF CHAOS--- TRUCK DEPOTS HAVE AN ABUNDANCE OF PETROL, DIESEL, AND OIL TO KEEP THE TRUCKS ON THE ROAD AT ALL TIMES.

TRUCK DEPOTS HAVE HIGH TRAFFIC AND ONLY A FEW WAYS IN AND OUT FOR THE RIGS WHICH OCCUPY THEM.

TRUCK DEPOTS ARE ALWAYS PRESENT NEAR STATE LINES AND BORDERS.

TRUCKS AND DEPOTS

PAGE 2

CONSIDERATIONS, CONTINUED.

MOST TRUCKERS THEMSELVES ARE MIDDLE CLASS WHITE GUYS JUST LOOKING TO FEED THEIR FAMILY. WHILE THEY ARE CONTRIBUTING TO THE SYSTEM WHICH HARMS US, THEY MAY NOT BE AWARE OF THE RAMMIFCATIONS OF THEIR ACTIONS.

THERE IS, HOWEVER, A GROWING NUMBER OF NON-WHITE (EAST INDIAN) TRUCKERS WHO FORM THEIR OWN COMPANIES AND ONLY HIRE THEIR OWN. TAKE NOTE WHILE HURTING THEIR TRUCKS THAT ONE TRUCK IS KNOWN TO HOUSE MANY INDIAN DRIVERS INSTEAD OF JUST ONE.

THE INDIAN TRUCKS ARE LESS COMMON AT OVERNIGHT STOPS BECAUSE THE INDIANS INSIDE SWITCH OUT THEIR DRIVERS PERIODICALLY TO KEEP THE TRUCK ON THE ROAD.

INDIANS VERY OFTEN PLACE THEIR OWN CULTURAL AND RELIGIOUS SYMBOLISM ON THEIR TRUCKS.



PROCEDURES

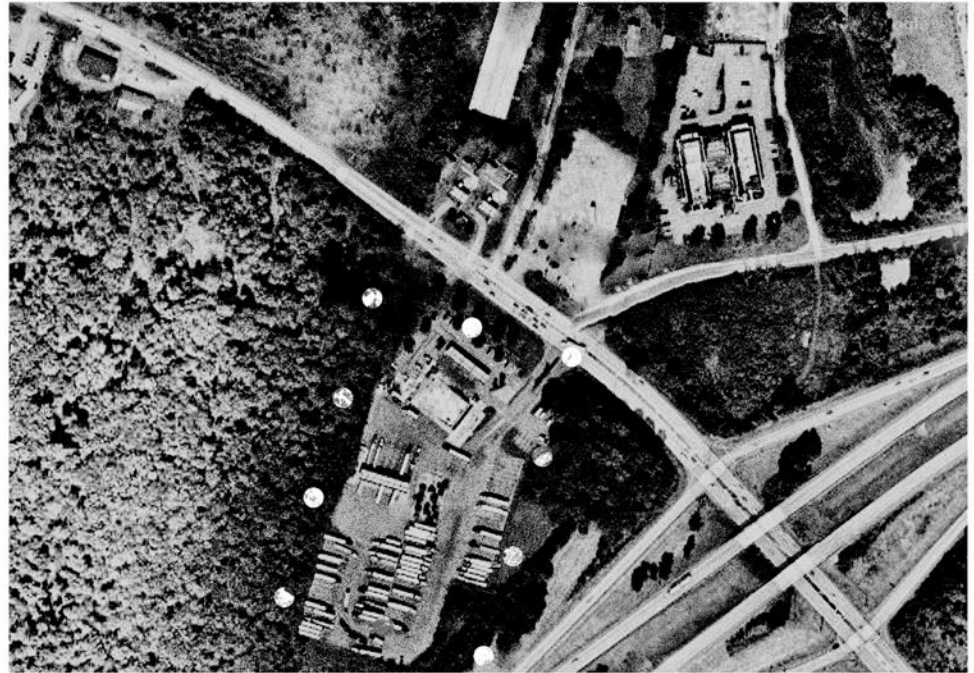

AREA FAMILIARIZATION IS THE FIRST AND MOST IMPORTANT STEP OF THIS TYPE OF SABOTAGE. TAKE NOTE OF THE GEOGRAPHY SURROUNDING THE DEPOT, BUT ALSO MAKE NOTE OF MANMADE DETAILS SUCH AS WHERE THE TRUCKS COME IN AND LEAVE, AMENITIES PROVIDED TO THE TRUCKS, AND THE FUELING STATIONS FOR THE TRUCKS THEMSELVES.

IF APPROACHING BY RURAL AREAS SURROUNDING: NOTE THE RECENT WEATHER AND AREAS OF BOGS. MAKE A SLOW AND CONSISTENT APPROACH WITH A PROPER ESCAPE FROM THE WOODS. DO NOT USE WHITE LIGHT TO GUIDE YOURSELF. THERE COULD BE TRAIL CAMERAS PRESENT, ALWAYS STAY MASKED UP FOR 100% OF THE SABOTAGE.

IF APPROACHING BY URBAN AREAS WITHIN: USE A BICYCLE OR SOME OTHER KIND OF UNMARKED TRANSPORTATION. IF USING SOME KIND OF STREET BIKE, ENSURE ALL IDENTIFIABLE MARKINGS HAVE BEEN REMOVED AND THAT THE MACHINE ITSELF IS IN PROPER WORKING ORDER.

IF MAKING USE OF ROOFING NAILS: SCATTER THEM EVERYWHERE. A SABOTEUR CAN SIMPLY RIDE HIS BICYCLE AROUND THE DEPOT WITH A BACKPACK OR BUCKET FULL OF NAILS, SCATTERING THEM EVERYWHERE AND ENSURING HE NEVER ENTERS THE SAME AREA TWICE.

IF HURTING NON-WHITE TRUCKS: USE A CUTTING TOOL FROM A SAFE DISTANCE TO REMOVE THE VALVE STEMS FROM TIRES. NOTE THAT THIS IS QUICK, BUT ALSO VERY LOUD AND DANGEROUS TO THE SABOTEUR. DON'T USE SMALL CUTTERS LIKE PLIERS OR TIN SNIPS, BUT INSTEAD SOMETHING LONGER THAT GETS YOU AWAY FROM THE TIRE WHILE DESTROYING IT. USE CYANOACRYLATE (MODEL AIRPLANE GLUE) TO FILL ANY LOCKS INCLUDING THE ONES ON ANY DOORS OR TRAILERS FOR THE TRUCKS THEMSELVES. PLUG EXHAUST PIPES WITH ANY MATERIAL YOU SEE FIT. IF THE TRUCK IS PARKED FOR THE NIGHT, THE EXHAUST PIPES CAN BE PLUGGED WITH A RUBBER BALL COATED WITH MARINE EPOXY, HAMMERED DOWN THE EXHAUST PIPE WITH SOME KIND OF DOWEL. BEST IF DONE WITH MULTIPLE BALLS. STEAL LICENSE PLATES, ESPECIALLY WHEN THE TRUCK IS OUT OF STATE.

TRUCKS AND DEPOTS

PAGE 3

PROCEDURES



WHILE UTILIZING FIRE FOR COMPLETE CHAOS: UTILIZE GOOGLE MAPS STREET VIEW (USING A VPN AND A SECURE SYSTEM) TO DETERMINE GENUINE ATTACK ANGLES. THE HIGHLIGHTED SCREENSHOT ABOVE SHOWS THAT JUST OFF THE SIDE OF THE HIGHWAY, THIS DEPOT HAS FIXED PROPANE TANKS WHICH ARE VULNERABLE TO A HOST OF IMPROVED EXPLOSIVES AND EVEN HIGH CALIBRE GUNFIRE. NOTE THAT A BASIC FIRE FROM A FIREBOMB WOULD NOT BE SUFFICIENT HERE BECAUSE OF BOTH THE DISTANCE TO THE TANKS, AND THEIR DURABILITY AGAINST BASIC OPEN FLAME.



CONTINUING THE UTILIZATION OF FIRE: THE SAME DEPOT FROM A NEW ANGLE SHOWS A SURROUNDING FENCE, AND CAMERAS AT THE TOPS OF THE POLES. WITH SERIOUS ACTION IN THE SABOTEUR'S MIND, THERE MUST BE SERIOUS PLANNING AND SERIOUS PRECAUTIONS IN PLACE. ALSO NOTED IS THE PRESENCE OF A FIRESTATION RIGHT BESIDE THE DEPOT, PERHAPS THIS DEPOT WOULD BE A BETTER VICTIM BY OTHER METHODS OF SABOTAGE MENTIONED IN THIS PASSAGE. ALWAYS SEARCH THE AREA FOR NEARBY POLICE AND FIRE SERVICES.



CONTINUING THE UTILIZATION OF FIRE: NEARBY THE FIRST DEPOT, ANOTHER IS LOCATED. YET THIS DEPOT HAS A VARIETY OF EXPOSED PUMPS AND NO FIRESTATION OR POLICE STATIONS PRESENT NEARBY. THE DEPOT ITSELF HAS RURAL AREAS SURROUNDING IT WHICH THE SABOTEUR COULD USE FOR COVER WHILE USING A SUPPRESSED RIFLE TO DESTROY THE PUMPS AT THIS DEPOT. THE SABOTEUR COULD USE A BICYCLE TO PASS THROUGH, LEAVING AN IMPROVISED EXPLOSIVE DEVICE AT THE PUMPS, USING HIS BICYCLE TO RETURN TO A NORMAL VEHICLE PARKED NEARBY SO THAT HE CAN MAKE HIS ESCAPE.

IF SHUTTING THE PLACE DOWN IS THE IDEA: THE SABOTEUR COULD UTILIZE THE ELECTRICAL (08) GUIDE TO REMOVE ELECTRICITY AND THEREFORE SERVICE FROM THE AREA. MANY DEPOTS HAVE THEIR OWN BACKUP GENERATORS, BUT IF THEY'RE BEING USED THEN THE SABOTEUR HAS STILL MADE A WIN, COSTING THE DEPOT TIME AND MONEY ON TOP OF TYPICAL OPERATING COSTS.

IF SHUTTING THE PLACE DOWN EFFORTLESSLY IS THE IDEA: THE SABOTEUR COULD WAIT FOR THE MONTHS LEADING UP TO BLACK FRIDAY, OR BOXING DAY AND CALL IN CONSTANT BOMB THREATS, ENSURING TRUCKS CANNOT USE ANY OF THE DEPOTS IN AN AREA FOR FUELING, CUTTING DOWN ON THE AMOUNT OF PLASTIC GARBAGE AVAILABLE IN HIS OR HER OWN AREA.

ROADS, BRIDGES, AND HIGHWAYS

TAKE AWAY THEIR ABILITY TO MOVE

04

HISTORY

A COMMON TARGET THROUGHOUT HISTORY, IN PARTICULAR FOR THE MEANS OF WAR, AND BY ECO-MINDED INDIVIDUALS.

AS EARLY AS 1861, BRIDGE BOMBINGS HAVE BEEN A TOOL EMPLOYED BY THOSE WITH AN INTENT TO SLOW OR STOP THINGS ENTIRELY. IN 1861 UNION SYMPATHIZERS BLEW BRIDGES IN TENNESSEE.

IN 1915, SABOTEURS ATTACKED BRIDGES WITH BOMBS OVER THE US-CANADA BORDER.

1951, STRIKING WORKERS DID THE SAME IN NEW ZEALAND.

1970-1990, ECO-SABOTEUR GROUP CHANGING AMERICA DESTROYED LOGGING ROADS AMONG OTHER ACTIONS COMMITTED.

1987-1990, EARTH FIRST! ACTIVISTS SABOTAGED LOGGING ROADS TO PREVENT DEVELOPMENT.

2002, COMMUNISTS REMOVED IMPORTANT RAIL PARTS ON A BRIDGE IN INDIA KILLING UPWARDS OF 200 PEOPLE.

2022, COMMUNISTS ATTEMPTED TO DISABLE HIGHWAYS IN CANADA BY SCATTERING THEM WITH NAILS.

CONSIDERATIONS

TRAFFIC CAMERAS ARE BECOMING A MORE AND MORE COMMON REALITY IN DEVELOPED NATIONS.

MANY HIGHWAYS EMPLOY SPEEDING CAMERAS IN EUROPE. AMONG MANY OTHER HIGHWAY CAMERAS WORLDWIDE.

SOME COUNTIES USE FIXED WING AIRCRAFT TO WATCH THEIR HIGHWAYS FOR SPEEDING VEHICLES, AND WILL EASILY SEE YOU AS WELL.

MANY BRIDGES ARE ENGINEERED BY QUALIFIED WHITES, BUT BUILT BY INCOMPETANT NON-WHITES.

ANYONE WHO SEES YOU BREAKING THE ROAD IS GOING TO BE AGAINST YOU.

DROPPING A BRIDGE DISABLES ALL THREE THINGS MENTIONED IN THIS PASSAGE AT ONCE.

TRANSPORTATION INFRASTRUCTURE IS ERODING AND FALLING APART IN MOST OF THE WORLD, NEGLECTED BY ITS OVERWATCHING GOVERNMENTS.

IMPACT

AN ATTACK ON THIS KIND OF INFRASTRUCTURE IS A DIRECT ATTACK ON LOGISTICS. EVERYONE FROM BLUE COLLAR WHITE WORKING CLASS MEN TO BILL GATES, AND SUMNER ROTHSTEIN THEMSELVES UTILIZE IT IN SOME WAY OR ANOTHER.

THE SYSTEM PRESENTLY TAKES YEARS TO COMPLETE EVEN SIMPLE BRIDGE PROJECTS. THIS TIMELINE CAN BE WORSENERD BY OTHER GUIDES PRESENTED IN THIS BOOK. WHAT COULD HAVE BEEN A WEEK FOR A ROAD TO BE REPAIRED, OR A FEW MONTHS FOR A BRIDGE (WHEN RUSHED) COULD BE DELAYED YEARS DEPENDING ON DAMAGE AND CONTINUED ACTION BY THE SABOTEUR.

DEPENDING ON WHO IS AFFECTED, WILL CAUSE THE SYSTEM TO RECOIL AND REACT IN DIFFERENT WAYS, BUT NO MATTER THEIR REACTION, THE ECONOMY, OPERATION, OR PROJECT OF A REGION CAN BE HURT.

ROADS, BRIDGES, AND HIGHWAYS PAGE 2

PROCEDURES, GETAWAY GETAWAY WITH DIRTBIKES?

IR LIGHTS ON YOUR PLATES?

DIRTBIKES AND ATVS ARE "GET AWAY FROM POLICE FREE" CARDS. PLAY THEM AS OFTEN AS YOU CAN. YOUTUBE SEARCH: "NO PLATE NO CASE", "DROP A GEAR AND DISAPPEAR BIKE". THERE ARE THOUSANDS OF VIDEOS OF MEN SIMPLY LEAVING THE ROAD AND HEADING IN TO THE FIELDS, OR TRAILS, COMPLETELY LOSING THE POLICE IN THEIR DUST.

IF YOU'D LIKE TO STILL HAVE PLATES ON YOUR VEHICLE BUT DON'T WANT THEM TO BE IDENTIFIED, THEN RESEARCH INFRARED-INVISIBLE LICENSE PLATE COVERS AND INFRARED-LED LICENSE PLATE COVERS. BOTH WILL PREVENT YOUR LICENSE PLATES FROM BEING PHOTOGRAPHED OR SEEN ON VIDEO.

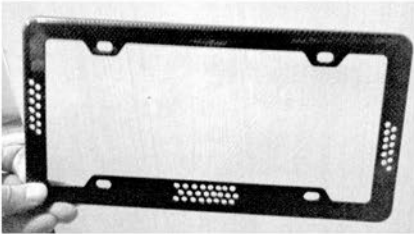

THE IDEAL PRACTICE OF SABOTAGE WOULD HAVE THE SABOTEUR NOT RELIANT ON THE VERY ROADS AND BRIDGES HE OR SHE IS DESTROYING.

GET OFF-ROAD, THE RISK WILL BE LOWER. STRIKE TARGETS WHERE OFF-ROADING TRACKS HAVE ACCESS. **PROCEDURES, ROAD/HWY NAILS.** ROOFING NAILS, DRYWALL NAILS, AND FURNITURE NAILS. THOUGH THEY DON'T ACTUALLY DESTROY THEIR TARGET, THEY DO DISABLE IT. TEAMS AND PICKUP CREWS WITH MAGNETIC RAKES WILL NEED TO SPEND DAYS OR WEEKS COMBING OVER AN AREA TO ENSURE DRIVERS CAN SAFELY CONTINUE THEIR JOURNEY.

THE PROCEDURE FOR DUMPING THE NAILS ISNT ONE STATIC METHOD,

BUT IS VERY UNIVERSAL.

A SABOTEUR CAN SIMPLY DRIVE A TRUCK WITH MANY LOOSE NAILS IN ITS BED, ALLOWING NAILS TO GRADUALLY ROLL AND FALL OUT. THE SABOTEUR CAN GO ABOVE A HIGHWAY AND SCATTER THEM BELOW. A SABOTEUR CAN USE A BICYCLE TO TRAVEL UP AND DOWN HIGHWAY ON/OFF RAMP WITH A BUCKET, DISPERSING THEM ALL OVER THE PLACE. ALL OF THIS IS BEST DONE SUNDAY NIGHT, BEFORE MONDAY MORNING'S CITY TRAFFIC CAN BEGIN 0400-0500.



DRYWALL ROOFING FURNITURE

DUMPING USED MOTOR OIL ON ROADWAYS IS ANOTHER WAY TO DISABLE THEM. IDEALLY DONE DURING THE SUMMER MONTHS IF A REGION EXPERIENCES SNOW (AND THEREFORE WILL HAVE SALTED ROADS). THE PROCEDURES OF DISTRIBUTION ARE THE SAME AS WITH NAILS, BUT IF DONE BY A TRAVELLING VEHICLE (WITH, FOR EXAMPLE, A HOLE CUT IN THE FLOOR TO DUMP OIL) IT WILL BE FAR MORE OBVIOUS WHICH VEHICLE IS CAUSING THE SABOTAGE.

WHEN IN DOUBT, AND IN AREAS EXPERIENCING A PERIOD OF ISOLATION, THE SABOTEUR CAN ALWAYS TAKE TO SMASHING THE ROAD THEMSELVES BY MEANS OF A SLEDGE HAMMER, POWER TOOL, OR EXPLOSIVE. THIS IS NOT A NOTABLY TIME-EFFICIENT METHOD AND DETECTION RISK IS HIGH. BEST EMPLOYED IN CONTROLLED AREAS WHERE THE SABOTEUR WANTS TO CAUSE SPECIFIC DAMAGE OR DELAY.

PROTESTORS IN HONG KONG CONSTRUCTED SMALL NAIL ROADBLOCKS AS WELL UTILIZING PLASTIC TUBING AND NORMAL NAILS.



A FINAL MENTION IS ONE IMPROVED AND PRACTICED BY DEMONSTRATORS IN HONG KONG. THE DISTRIBUTION OF BRICKS IN AN UPRIGHT POSITION, AND WITH ANOTHER ACROSS THEM CAN BE USED TO BLOCK TRAFFIC, BUT WILL BE EASILY PICKED UP WHEN DESIRED.



PROCEDURE, OBSERVATION

A SABOTEUR COULD USE A CHEAP OBSERVATION DRONE ON A LOW-WIND DAY IN ORDER TO VIDEO THE BRIDGE AND TO STUDY IT LATER. THE SABOTEUR SHOULD ASK SEVERAL QUESTIONS WHILE REVIEWING THEIR FOOTAGE:

DOES THE BRIDGE HAVE A MAINTENANCE TUNNEL WITHIN?

CAN I ACCESS THE TUNNEL? AND IF SO, HOW CAN I ACCESS IT?

IS THE BRIDGE BEGINNING TO FAIL ON IT'S OWN? HAVE WEAKNESSES REVEALED THEMSELVES?

HOW COMMON IS TRAFFIC ON THE BRIDGE? ARE THERE PEDESTRIANS AS WELL PRESENT ON THE BRIDGE?

A SABOTEUR CAN UTILIZE A TRAIL CAMERA OR SIMILAR IN THE AREA OVERLOOKING THE BRIDGE TO ALSO DETERMINE GENERAL TIMES OF TRAFFIC AND INSPECTION.

THE SABOTEUR SHOULD ALSO DETERMINE A ROUTE BASED ON WHAT IS AROUND AND UNDER THE BRIDGE. IF THE BRIDGE GOES ABOVE A RAIL CROSSING THEN THE SABOTEUR CAN EASILY UTILIZE AN OFF-ROAD VEHICLE TO NAVIGATE TO THEIR TARGET. ABOVE WATER, AND THE SABOTEUR WILL NEED TO CONSIDER OTHER MEANS.

ROADS, BRIDGES, AND HIGHWAYS PAGE 3

PROCEDURES, BRIDGES CUT THE BRIDGE DOWN?

BLOW THE BRIDGE?



OLDER STEEL BRIDGES ARE INVITING TARGETS FOR THERMITE IN ITS MANY CLASSES. IF A SABOTEUR WISHES TO STRIKE A STEEL BRIDGE, RESEARCH IN TO WHICH TYPES OF THERMITE EXIST, CAN BE MADE BY THE SABOTEUR, AND WHICH ONE (AND IN WHAT QUANTITY) WILL BE NEEDED TO ACTUALLY HURT A BRIDGE. AN ATTEMPT IS NO SUCCESS, AS IT WILL ONLY INCREASE ENEMY SECURITY IN THE AREA AND REGARDING BRIDGES NATION-WIDE.

BRIDGES WHICH UTILIZE CABLES FOR STRUCTURAL INTEGRITY SHOULD NOT BE SPARED FROM THE THERMITE-UTILIZING SABOTEUR EITHER. THE WIRES THEMSELVES ARE TARGETS, BUT MORE IMPORTANTLY, THE SOMETIMES HIDDEN (WITHIN THE BRIDGE) BRACKETS WITHIN THE BRIDGE THAT HOLD MANY BRACKETS AT ONCE ARE A BETTER TARGET FOR THERMITE OR SIMILAR MEANS.

DIAGRAMS OF BRIDGE CONSTRUCTION AND WEAKNESSES CAN BE FOUND SOMETIMES FOR MANY TYPES OF BRIDGES.



BLOWING THE BRIDGE IS A MUCH MORE GRAND PROCEDURE, AND REQUIRING OF GREATER PLANNING AND KNOWLEDGE THAN MERELY BURNING THROUGH WIRES.

IN ACCORDANCE WITH OBSERVATION, A SABOTEUR CAN DETERMINE WAYS INSIDE OF A BRIDGE IF POSSIBLE. THEY CAN DETERMINE THE BEST POINTS OF PLACEMENT WITH THE RELATIONSHIP OF STRUCTURAL INTEGRITY TO EROSION IN MIND.

A SABOTEUR CAN EVEN CREATE PLACES FOR THEIR BOMB IF NEEDED, BY CREATING DAMAGE IN TO STRUCTURAL CONCRETE AND PLACING THEIR DEVICES WITHIN.

CONSIDERATIONS, EXPLOSIVES

THE SABOTEUR SHOULD BE AT LEAST FAMILIAR WITH BASIC CHEMISTRY BEFORE ATTEMPTING THE CREATION OR PRODUCTION OF ANY DEVICES. YOU, THE SABOTEUR, IS A VERY UNIQUE CLASS OF PERSON APPEARING VERY RARELY WITHIN A POPULATION. DYING BY A SIMPLE MISTAKE SUCH AS TIGHTENING A CAP DOWN WHERE THERE COULD BE GUNPOWDER PRESENT IN THE THREADS, OR INHALING A RESULTING GAS WHEN MIXING COMPOUNDS IS A STUPID AND SHAMEFUL WAY TO DIE.

THE DEVICE PREPARED SHOULD HAVE A CALCULATED EFFECT, WITH THE SABOTEUR RESEARCHING THE RELEVANT DETONATION RATE, BRISTANCE (SHATTERING RATE), HEAVING VALUE, REACTIVITY, AND METHOD OF DETONATION FOR EACH DEVICE HE OR SHE IS DETERMINED TO CREATE.

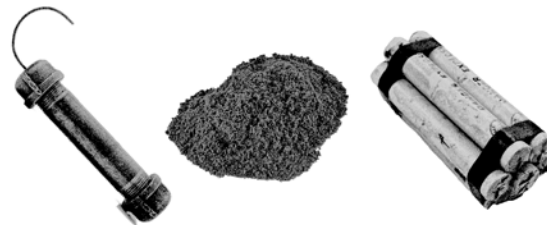

CHOKE POINTS

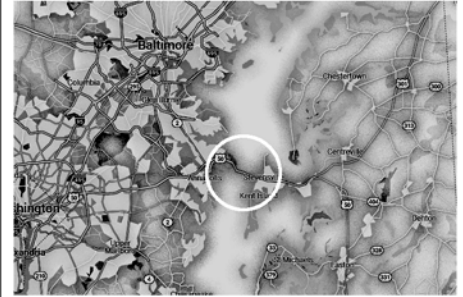

THE SABOTEUR SHOULD UTILIZE MAP SERVICES AS OFTEN AS POSSIBLE WHILE CONSIDERING CREATING A CHOKE POINT.

DUE TO POPULATION AND INFRASTRUCTURE DENSITY, SOME AREAS LIKE THE EASTERN UNITED STATES OR WESTERN EUROPE AREN'T IDEAL PLACES FOR CREATING CHOKE POINTS. ROADS AND HIGHWAYS RUN IN ABUNDANCE IN ALL DIRECTIONS.

THE SABOTEUR CAN FIND IDEAL POINTS, HOWEVER, WHEN ALL THAT CONNECTS AN AREA TO ANOTHER IS A SINGLE BRIDGE.

PICTURED ABOVE IS A SET OF TWO SMALL BRIDGES IN PARALLEL WHICH MAKE UP ONE OF ONLY THREE WAYS ON TO A LARGE PORTION OF DELAWARE AND WASHINGTON STATE.

WATER TREATMENT AND DISTRIBUTION

ONE LIFE-FORCE KEEPING THE CITIES ALIVE

05

HISTORY

WHILE MOST ATTACKS ON THE WATER HAVE BEEN AN ACT OF CONVENTIONAL WAR, THERE HAVE BEEN A GREAT NUMBER OF CYBER ATTACKS DUE TO PLANTS OFTEN REUSING PASSWORDS, USING DEFAULT PASSWORDS IN ABUNDANCE, OR OTHER EASILY AVOIDED MISTAKES. THIS GUIDE WON'T COVER WAR-RELATED ATTACKS OR CYBER-SABOTAGE HOWEVER. AND INSTEAD WILL FOCUS ON LESS-COMMON DIRECT ACTION BY A LONE SABOTEUR.

2011, A PLANT IN NJ IS ATTACKED 15 TIMES BY VANDALS WHO SHUT OFF THE WATER AND THREW THINGS IN TO THE FILTRATION SYSTEMS.

2018, A PLANT IN SOUTH AFRICA IS SHUT DOWN BECAUSE OF DAMAGE.

2019, A PLANT IN MAYANMAR A SABOTEUR DUMPED A GREAT DEAL OF DIESEL IN TO THE WATER SUPPLY, CAUSING ISSUES FOR 700,000 PEOPLE.

2019, A PLANT IN SOUTH AFRICA WAS VANDALISED TO THE POINT OF SABOTAGE.

2022, ATTACKS AGAINST DONETSK WATER PLANTS ARE CARRIED OUT BY UA AND POLISH SABOTEURS.

CONSIDERATIONS

-----THE PATH-----
SOURCE»
FLOCCULATION»
SEDIMENTATION»
FILTRATION»
DISINFECTION(RADIATION)»
STORAGE»
TRANSPORTATION.

-----SECURITY-----
WATER TREATMENT PLANTS ARE TYPICALLY STATE-RUN AND HAVE A VERY HIGH LEVEL OF SECURITY. EXPECT THE USUAL TECHNOLOGY AND MAN BASED SECURITY SOLUTIONS TO BE EMPLOYED BY THIS TYPE OF TARGET.

-----YOU-----
DO YOU HAVE YOUR OWN MEANS TO FILTER WATER? IT WOULDN'T MAKE MUCH SENSE TO DESTROY YOUR OWN MEANS OF SURVIVAL.

MAKE SURE YOU HAVE AN APPROPRIATE FILTER FOR YOUR REGION WITH CONSIDERATIONS LIKE INDUSTRIAL AND FARM RUN-OFF BEFORE MAKING ANY MOVES.

ENSURE THE FILTER HAS A CAPACITY HIGH ENOUGH FOR YOURSELF, YOUR FAMILY, AND YOUR COMRADES.

IMPACT

MODERN PEOPLE DON'T KNOW HOW TO TAKE CARE OF THEMSELVES.

A STRIKE TO THIS TARGET DURING ORDINARY TIMES OF PEACE WOULD SIMPLY LEAD TO BOTTLED WATER BEING SHIPPED IN, AND BECOMING "THE NEW NORMAL" IN A REGION UNTIL INFRASTRUCTURE WAS REPAIRED.

A STRIKE TO THIS TARGET DURING A TIME OF UNREST, TURMOIL, SHORTAGE, OR DECAY WOULD MEAN LARGE AMOUNTS OF THE POPULATION DYING FROM SICKNESS. THE VAST MAJORITY HAVE NO MEANS AND NO KNOWLEDGE REGARDING PERSONAL WATER FILTRATION.
SEE "YOU" UNDER CONSIDERATIONS.

IN EITHER CASE, THE GOVERNMENT RESPONSE WOULD BE GIGANTIC. EXPECT THEM TO DESPERATELY ATTEMPT TO HUNT THOSE RESPONSIBLE FOR CUTTING OFF THE DRINKING AND WASHING WATER OF THEIR LEMMINGS.

WATER TREATMENT AND DISTRIBUTION PAGE 2

PROCEDURES, GENERAL

WHILE FOLLOWING ALL OBSERVATIONAL STEPS OUTLINED IN PREVIOUS HEADERS, THE SABOTEUR SHOULD UTILIZE OFF-ROAD VEHICLES, DRONES, TRAIL CAMERAS, BICYCLES, AND ONLINE MAP SERVICES IN ORDER TO SURVEY HIS OR HER TARGET SUFFICIENTLY TO DETERMINE SECURITY LEVELS, PEDESTRIAN AND VEHICLE PRESENCE, AND ANY OTHER DETAILS WHICH COULD AFFECT COMMITTING THE SABOTAGE.

PROCEDURES, TOWERS

TOWERS, THOUGH BEING PHASED OUT IN DEVELOPED AND METROPOLITCAN AREAS (THEMSELVES THE TARGETS OF THIS GUIDE), ARE HUGE CAPACITIES OF WATER HELD UP HIGH IN ORDER TO FEED AREAS THE WATER THEY NEED, UTILIZING GRAVITY AS A DISTRIBUTION METHOD. THEY ARE ALSO USED AS EMERGENCY TOWERS FOR FIRE FIGHTERS, MAKING SOME TOWERS EFFICIENT TARGETS WHEN THE SABOTEUR IS RELYING ON ANY TYPE OF ARSON.

THE EASIEST TARGET OF THE TOWER IS ITS PUMP, REQUIRED TO CARRY WATER IN TO IT. TOWERS TYPICALLY LOSE CAPACITY DURING THE DAILY PEAK HOURS AND REGAIN IT THROUGH THE PUMP'S WORK OVERNIGHT. THESE ARE HUGE INDUSTRIAL GRADE PUMPS OFTEN LOCKED AWAY IN PUMP HOUSES NEAR THE TOWER. IF THE SABOTEUR CAN GAIN SAFE ACCESS TO THE PUMP HOUSE, THEN THE PUMP ITSELF CAN BE BURNED, SHOT, BLOWN UP, OR SHORTED OUT ELECTRICALLY IN ORDER TO STOP IT.

MAINTENANCE WORKERS WILL LIKELY MAKE A SWIFT REPAIR, AND SECURITY WILL BE INCREASED, MAKING THE PUMP A MOMENTARY TARGET IN THE SITUATION THE SABOTEUR WILL BE COMMITTING NEARBY ARSON OVERNIGHT OR IN THE EARLY HOURS OF THE MORNING.

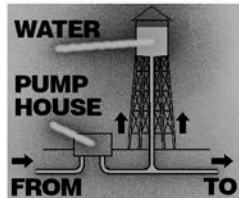

HURTING THE TOWERS THEMSELVES IS NO EASY FEAT. THERE ARE MANY TOWER TYPES, WITH MANY EMPLOYING A MUCH MORE DURABLE REINFORCED CONCRETE/BRICK ENCASED DESIGNS, FLUTED COLUMN, OR A STEEL POLE DESIGN.

THE TYPE OF TOWERS WITH WEAKNESSES ARE BOTH MOST ROOFTOP AND MULTI (STEEL) COLUMN TOWERS.



THESE TYPES OF TOWERS UTILIZE WEAKER STEEL LEGS WHICH CAN BE KNOCKED AWAY BY USE OF THERMITE, EXPLOSIVE, OR EVEN BY THE USE OF WEIGHT IN SOME ROOFTOP CASES.

FOR MANY TOWERS, THE LOSS OF EVEN ONE LEG WOULD BE SUFFICIENT TO CAUSE IT TO COME CRASHING DOWN. THE SABOTEUR CAN MAKE THEIR WORK EVEN MORE EFFICIENT BY DROPPING THE TOWER ON ANY NEARBY POWERLINES.

ROOFTOP TOWERS COULD HYPOTHETICALLY BE TAKEN DOWN BY TYING CHAINS TO A LEG AND CAUSING A PORTION OF A BUILDING (SUCH AS A SIGN OR BILBOARD) TO FALL, THOUGH THIS IS AN UNCONVENTIONAL METHOD.

A MORE CONVENTIONAL METHOD OF TAKING DOWN ANY TOWER LIKE THIS IS TO USE THERMITE TO DESTROY ONE LEG. WITH THIS AS WELL, THE SABOTEUR CAN CHOOSE THE FALL DIRECTION AND TRUE EFFECT OF SUCH A HUGE TOWER FALLING. IT WILL ALSO FLOOD AN AREA GREATLY.

PROCEDURES, PIPES

MOST MAJOR CITIES HAVE INDEXABLE MAPS OF THEIR WATER GRID ONLINE FOR ANYONE TO FIND.

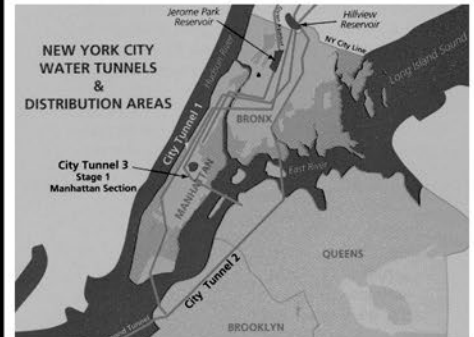

IN ORDER FOR PIPE ATTACKS TO BE VIABLE, THE SABOTEUR MUST RELY ON CREATING CHOKE POINTS WITHIN GRIDS.

PIPES ARE SOMETIMES ACCESSIBLE IN UNDERGROUND TUNNELS FOUND IN AND AROUND CITIES, AND AROUND BODIES OF WATER. A GREAT DEAL OF PRECAUTION NEEDS TO BE TAKEN WHILE TRAVERSING SUCH TUNNELS AS MANY OF THEM FILL WITH WATER AND CAN TRAP OR DROWN THE SABOTEUR DURING RAINY SEASONS.

PROCEDURES, PLANTS

THE SABOTEUR HAS TWO PRIMARY METHODS WHILE SABOTAGING WATER TREATMENT PLANTS: THE POISONING OF WATER, OR THE DESTRUCTION OF THE PLANT ENTIRELY.

POISONING THE PLANT HAS MANY RAMMIFICATIONS WHICH CANNOT BE CONTROLLED BY THE SABOTEUR, THE POISON COULD END UP AFFECTING PEOPLE HE OR SHE DID NOT INTENT TO HARM.

A MUCH GREATER AND CONTROLLED DEAL OF DAMAGE CAN BE INFLICTED BY THE DISABLING OR DESTRUCTION OF THE ENTIRE PLANT ITSELF.

SABOTAGE OF THE PLANT WOULD BE THE SAME AS DESTROYING ANY OTHER INDUSTRIAL OPERATION, WITH THE IMPACT HEADER MORE SPECIFICALLY CONSIDERED.

THE DIAGRAM ON THE FOLLOWING PAGE OUTLINES THE MOST IDEAL TARGETS OF THE PLANT.

WATER TREATMENT AND DISTRIBUTION PAGE 3

STUDYING

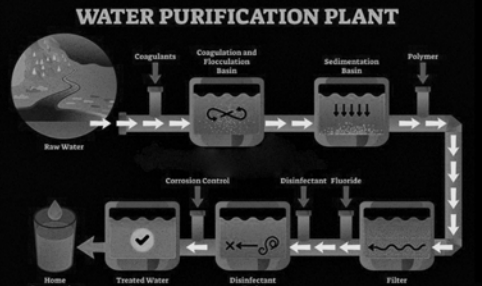
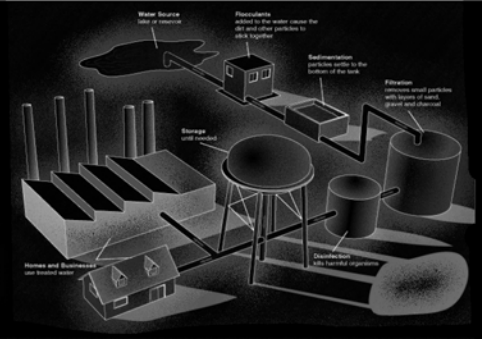
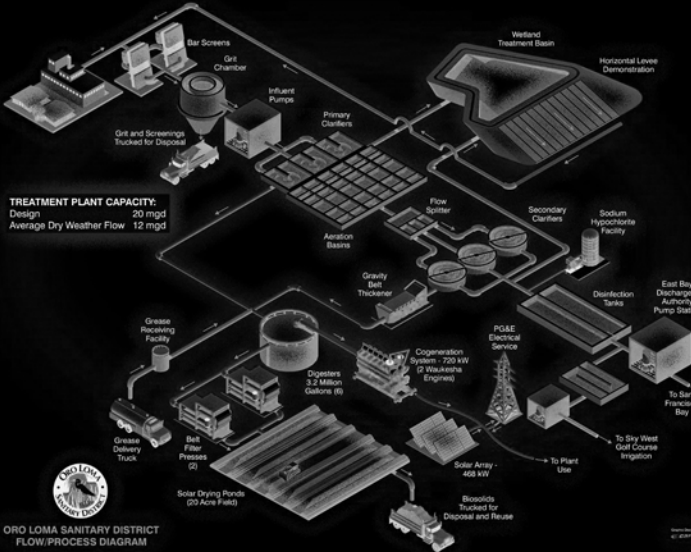

MANY OF THE COMPONENTS OUTLINED IN THESE DIAGRAMS COULD BE DISABLED BY LONG DISTANCE GUNFIRE.

THE SABOTEUR SHOULD INSTEAD CONSIDER THAT CHLORINE, PRESENT NEAR THE END OF THE WATER TREATMENT PROCESS IS AN OXIDIZER, CAUSING FIRES TO BURN FASTER, HOTTER, AND MORE INTENSLY.

THE CHLORINE ON SITE CAN ALSO FORM CHLORINE GAS, WHICH CAN POISON ANYONE NEARBY.

WHEN MIXED WITH TURPENTINE OR AMMONIA, CHLORINE GAS CAN FORM EXPLOSIVE COMPOUNDS.

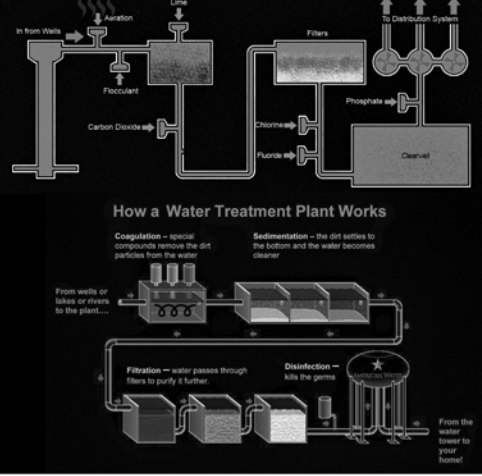
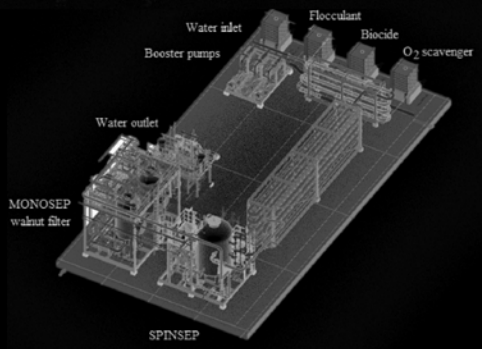
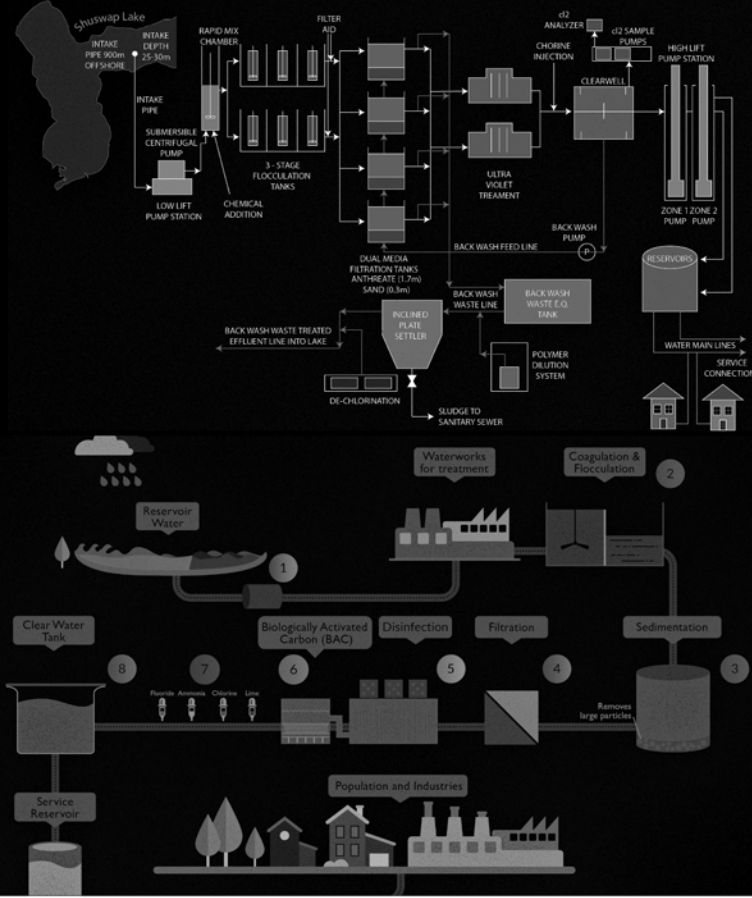



270

COMMERCIAL BUSINESSES

DISTRIBUTED DEGENERACY IN PLACE OF LOCAL COMMERCE



HISTORY

HISTORICALLY, LARGE DEPARTMENT STORES HAVE BEEN KNOWN TO ENTER AREAS AND ABSOLUTELY RAPE THE LOCAL COMMERCE BY UNDERCUTTING EVERYONE AT THE SAME TIME. IT HAS GOTTEN WORSE TODAY WITH THE ADVENT OF ONLINE SHOPPING WHEREBY THE SAME COMPANIES CAN DESTROY LOCAL ECONOMIES WITHOUT EVEN BEING PRESENT WITHIN THEM.

THE WEAKENED MASSES HAVEN'T DONE MUCH ABOUT THIS. BOYCOTTING HAS BEEN THE GOOD INTENTIONER'S PRIMARY FLACCID MEANS OF TRYING TO HURT THESE STORES TO NO EFFECT.

SOME "URBAN YOUTHS" HAVE SET FIRE INSIDE WALMART FOR FUN.

WALMART HAS BEEN EVACUATED A FEW TIMES FOR BOMB THREATS.

AN AMAZON WAREHOUSE RECEIVED A PACKAGE BOMB WHICH WAS SAFELY DETONATED IN THE PARKING LOT WITHOUT CASUALTY.

THE ONLY REAL THREAT TO THESE KINDS OF CORPORATIONS SINCE THEIR CONCEPTION HAS BEEN PEOPLE STEALING AND SCAMMING THEIR PRODUCTS AWAY.

IMPACT

WHETHER THE SABOTEUR WANTS TO GAIN PERSONAL PROFIT WHILE SILENTLY HURTING THE COMPANY, OR WHETHER HE WANTS TO BURN IT TO THE GROUND, THE IMPACT IS GOING TO BE FAR DIFFERENT.

IF THE SABOTEUR KEEPS THINGS QUIET, AND KEEPS PROFITING HE WON'T HURT THE CORPORATION MUCH; THE CORPORATION MAY NOT EVEN KNOW WHAT'S HAPPENING, OR IF THEY DO THEY MAY JUST CLASSIFY WHAT'S HAPPENING TO THEM AS A STATISTIC AND A LOSS IN THAT QUARTER.

IF THE SABOTEUR PUTS HIS OWN NEEDS ASIDE AND BURNS A WAREHOUSE DOWN, DESTROYS SOME PROPERTY, LEAVES A STORE MANAGER FLOPPY ON THE PAVEMENT, THEN THE CORPORATION WILL REALLY FEEL THE BURN, AND WILL BE FORCED TO ACKNOWLEDGE AND REACT TO THE SITUATION ALONGSIDE ANY LOCAL OR EVEN FEDERAL STATE FORCES WHICH WILL HELP PROTECT THE CORPORATION.

CONSIDERATIONS

ANY LARGE DEPARTMENT STORE IS GOING TO BE LOADED WITH ELECTRONIC SECURITY, PLAINCLOTHES LOSS PREVENTION STAFF, AND GOOD SAMARITAN SHOPPERS WITH NOTHING BETTER TO DO THAN TO LOOK VIRTUOUS IN EXCHANGE FOR YOUR ARREST.

THE WAREHOUSES WILL HAVE ALL THAT WITHOUT THE SHOPPERS, BUT WITH THE ADDITION OF FIXED SECURITY AND BIOMETRIC SECURITY MEASURES.

BOTH WILL OFTEN OPERATE 24H, BOTH WILL HAVE LOTS OF LOGISTICS VEHICLES PARKED AROUND THE LOT AND BEHIND THE BUILDING, BOTH RELY ON ELECTRICITY FOR OPERATION, BOTH UTILIZE THE INTERNET GREATLY, AND BOTH HAVE WINDOWS ONE CAN BREAK.

BANK BRANCHES ARE MUCH THE SAME WITH MANY TARGETS AMONG THEM, AND MANY RISKS.

SMALL STORES SHOULD NEVER BE TARGETTED UNLESS THEY ARE HOST TO A DEGENERATE BUSINESS. LIVE IN COLORADO, CALIFORNIA, CANADA, OR SOMEWHERE ELSE WHERE THE LAND IS LITTERED WITH WEED

COMMERCIAL BUSINESSES PAGE 2

CONSIDERATIONS, CONT

DISPENSARIES? MAYBE YOUR AREA IS JUST LITTERED WITH VAPE STORES AND SEX SHOPS? ALL OF THESE ARE LEGITIMATE TARGETS AND HAVE EVERYTHING FROM WINDOWS TO FLAMMABLE MATERIALS WITHIN THEM. THEY DEFINITELY ALL UTILIZE AIR CONDITIONING UNITS ON THEIR ROOFTOPS (GUIDE 09), THEY CAN ALL HAVE THEIR POWER CUT (GUIDE 08).

CONSIDERATIONS, WEB

THE ONLINE SPHERE OF WEBSTORES ARE OF COURSE, SUSCEPTIBLE TO CYBER ATTACK AND DATA LEAK. THIS IS NO GUIDE ON THESE METHODS, BUT THEY SHOULD BE CONSIDERED. WHAT THIS GUIDE DOES COVER IS HOW TO ABUSE AND SCAM THESE ONLINE SERVICES FOR YOUR OWN GAIN.

RETURNS ARE EASY.

YOU CAN LIE TO AMAZOG AND CHINA, IT'S NOT EVEN ILLEGAL.

DESTROY THINGS ON PURPOSE AND RETURN THEM, SHIPPING IS ON THE STOREFRONT AND NOT ON YOU 99% OF THE TIME.

LAUGH AS YOU CREATE A STATISTICAL LOSS IN THEIR QUARTERLY PROFITS, EVEN IF THAT LOSS IS SMALL FOR THEM.

PROCEDURES, GENERAL, IRL

SORTED BY TOOLS UTILIZED:

-----SLINGSHOT-----

THE SABOTEUR, IN A LOW-RISK MEDIUM-OUTCOME SCENARIO CAN MAKE USE OF ANY SLINGSHOT WITH PAINTBALLS OR BALL BEARINGS TO HURT A DEGENERATE STORE AND IT'S CUSTOMERS. MEDIUM-SIZE (1 INCH DIAMETER) BALLS WILL AT LEAST CRACK GLASS WITH A DECENT SLINGSHOT. NOTE THAT IF A WINDOW HAS A SCREEN IN FRONT OF IT, THE BEARING WILL LIKELY BOUNCE OR LIGHTLY DAMAGE THE SCREEN, MAKING THIS A BETTER TACTIC AGAINST LARGE BUSINESS WINDOWS OR PERSONAL WINDOWS WHERE NO SCREEN IS PRESENT. THEY ARE ALSO UNLIKELY TO HURT VEHICLE WINDOWS OFTEN, BUT CAN HAPPEN.

THE SABOTEUR SHOULD UTILIZE THE OPERATION RADIUS CONCEPT DISCUSSED ELSEWHERE IN THESE GUIDES, ALBERT WITH LESS RANGE THAN A FIREARM.



-----FIREARM-----

IF ATTACKING FROM A DISTANCE, THE SAME CONSIDERATIONS FOR THE SLINGSHOT SHOULD BE TAKEN. THE SABOTEUR SHOULD TAKE CARE TO SUPPRESS HIS WEAPONS AND PICK AN APPROPRIATE PLACE TO STRIKE FROM NOTING THAT FIREARMS USE WILL BE REGARDED MUCH MORE SERIOUSLY BY LAW ENFORCEMENT, AND ALL LOCAL CCTV CAMERAS WILL BE CHECKED TO FIND THE SABOTEUR.

NEW TARGETS SHOULD CERTAINLY INCLUDE OUTDOOR ELECTRONIC SECURITY EQUIPMENT, LIGHTS, VEHICLE TIRES, AND WINDSHIELDS OF CONFIRMED DEGENERATE CUSTOMERS AND EMPLOYEES.

FOR SABOTAGE, ALL THAT IS USUALLY NEEDED IS .22LR OR EVEN .22SHORT. NOTE THAT WHILE FIRING SUPPRESSED, ALL .22SHORT ON THE MARKET IS SUB-SONIC AND WILL BE MUCH MORE QUIET THAN ANY SUPER-SONIC LOADING.

NOTE THAT WHILE TARGETTING LARGE CORPORATE STORES, THE SABOTEUR SHOULD BE CAREFUL OF HURTING MANY OF THE CUSTOMERS, MANY OF WHICH ARE VICTIMS THEMSELVES OF DEAD LOCAL COMMERCE.

-----ARSON-----

FIRST AND FOREMOST THE SABOTEUR NEEDS TO CONSIDER THE FOUR RULES OF ARSON AS OUTLINED BY THE ELF IN 2001:

MOST HEAT FROM A FIRE RISES (HIT THE MOST VULNERABLE AREA WITH A LOW CEILING SUCH AS ATTICS AND RAFTERS).

THE HEAT NEEDS TO BE CONCENTRATED IN ONE PLACE (THROWING GAS ALL OVER THE PLACE IS A HOLLYWOOD GIMMICK, HEAT NEEDS TO STAY CONCENTRATED SO THINGS CATCH FIRE AND STAY ON FIRE).

THE HEAT NEEDS TO BE SUSTAINED OVER A PERIOD OF TIME (A QUICK FLASH OF EXTREME HEAT IS NOT PREFERABLE TO SUSTAINED NORMAL HEAT. TRANSFER OF ENERGY TO THE TARGET IN A

SUSTAINED MANNER IS PREFERABLE).

GUARANTEE DESTRUCTION OF THE TARGET THROUGH CAREFUL PLANNING AND EXECUTION (NO SHORTCUTS MEANS NO SUPPRISES, PLAN FOR THINGS TO GO WRONG, TEST DEVICES LIKE TIMERS AND FUSES BEFORE USE, USE MULTIPLE DEVICES IN PREPARATION ONE DOESNT WORK, BE GENEROUS WITH THE AMOUNT OF ACCELERANT YOU USE).

A QUICK FIRE IN THE FIREWORKS SECTION OF WALMART IS FUNNY, BUT IT'S TEMPORARY AND A HUGE RISK FOR THE SABOTEUR. IT NEEDS TO BE BIGGER.



IF A SABOTEUR WISHES FOR GUARANTEED DESTRUCTION, HE OR SHE NEEDS TO UTILIZE THERMITIC COMPOUNDS OR BUCKETS OF GASOLINE AND DIESEL.

A BENEFIT TO THESE METHODS AGAINST EXPLOSIONS IS THAT THEY'RE SILENT. IF A SABOTEUR IS ABLE TO GAIN ACCESS TO AN ISOLATED AREA WHICH IS IDEAL FOR BEGINNING THE FIRE, HE OR SHE CAN BE OUT OF THE AREA QUITE EASILY BY THE TIME THE FIRE IS DETECTED.

THE SABOTEUR COULD EASILY WEAR A COVID MASK AND SUNGLASSES, A SAFETY VEST, AND ANY OTHER EQUIPMENT NEEDED TO APPEAR AS A MAINTENANCE WORKER, WHILE CARRYING TWO 5-GALLON BUCKETS OF ACCELERANT TO BE LEFT AND LIT IN AN ISOLATED PLACE THEY COULD GAIN ACCESS TO BY MERELY FAKING LIKE THEY BELONG THERE.

IF THE SABOTEUR DID NOT WANT TO ACTUALLY ENTER A BUILDING, A THERMITE CHARGE COULD BE LEFT ON TOP OF FUEL TANKS, FUEL TRUCKS, OR ANY OTHER POTENTIAL EXPLOSIVE IN THE AREA OF THE STORE OR WAREHOUSE.

COMMERCIAL BUSINESSES PAGE 3

GENERAL, IRL, CONT

-----ARSON, CONT-----
MOLOTOV COCKTAILS ARE ANOTHER TOOL COMMONLY UTILIZED BY THE SABOTEUR.



IN THE SCREENSHOTS ABOVE, A MAN OFF THE STREET THROWS A MOLOTOV COCKTAIL INTO A DELI, CAUSING NEAR-COMplete DESTRUCTION OF THE STORE.

THE SABOTEUR CAN INFLICT QUICK DESTRUCTION ON ANY SMALL DEGENERATE STOREFRONT WITH THIS METHOD.

IT'S IMPORTANT TO NOTE A FEW THINGS WHILE CREATING AND UTILIZING MOLOTOVS.

THE SABOTEUR SHOULD SELECT A SUFFICIENT BOTTLE WHILE MAKING THE MOLOTOV. A BEER BOTTLE IS TYPICALLY TOO THICK, IF THE SABOTEUR THROWS THE MOLOTOV TOO HARD, THE FLAME MERELY BLOWS OUT AND THE BOTTLE BREAKS WITH FUEL GOING EVERYWHERE.

THE SABOTEUR NEEDS TO SELECT AN APPROPRIATE THIN BOTTLE THAT ALLOWS FOR THE MOLOTOV TO BE THROWN LIGHTLY SO AS NOT TO PUT OUT ITS FLAME, BUT SO THAT THE BOTTLE CAN EFFICIENTLY BREAK ON THE TARGET,

THE THROWING PROCESS OF A MOLOTOV IS IMPORTANT AS WELL. THE SABOTEUR SHOULD NEVER ALLOW THE MOLOTOV TO TILT, SHOULDN'T THROW IN A "SIDEWAYS" MANNER WHICH STILL IMPARTS ENOUGH FORCE TO BREAK THE BOTTLE, BUT THAT DOES NOT PLACE THE SABOTEUR IN DANGER OF POURING FLAMING FUEL DOWN HIS OR HER OWN BACK.



AN EXAMPLE FROM THE SAME VIDEO

CONSTRUCTION OF THE MOLOTOV IS SIMPLE. A BOTTLE IS FILLED WITH A FLAMMABLE LIQUID, PREFERBLY GASOLINE BUT KEROSENE, DIESEL, ETC. WILL WORK AS WELL.

THE SABOTEUR MAY ADD THE FOLLOWING TO INCREASE EFFICIENCY:

POLYSTYRENE (STYROFOAM), SHREDDED SOAP, OR USED MOTOR OIL IN ORDER TO CAUSE THE GASOLINE TO GEL AND STICK BETTER TO ITS TARGET. ADDING TOO MUCH CAN AFFECT HOW EASILY THE FUEL CAN CATCH FIRE, SO ADD THESE THINGS IN MODERATION. AS ALWAYS, EXTENSIVELY TEST YOUR DEVICES AND RATIOS BEFORE CONDUCTING SABOTAGE.

INSERT A RAG IN TO THE BOTTLE SO THAT THE END IN THE BOTTLE TOUCHES THE ACCELERANT, AND SO THAT THE SIDE OF THE RAG OUTSIDE OF THE BOTTLE SITS 20CM (8IN) OUT OF THE BOTTLE.

SEAL THE BOTTLE THE BEST YOU CAN UTILIZING STRING, TAPE, AND ZIPTIES.



-----A HAMMER-----
A SABOTEUR'S NIGHT CAN BE SO SIMPLE AS TO IGNORE THE REST OF THIS GUIDE, SIMPLY LEAVING HIS OR HER PHONE AT HOME, MASKING UP, STEALING A LOCAL BICYCLE FROM SOMEONE'S BACKYARD, AND THEN USING A BALL FACED HAMMER TO DAMAGE THE CORNERS OF ALL OF THE PLATE-GLASS WINDOWS AT A LOCAL BANK BRANCH.

THE SABOTEUR COULD RUN AROUND A PARKING LOT FOR 10 MINUTES AND SPIDER EVERY WINDSHIELD IN THE PARKING LOT OF A GAY CLUB, LOOKING OUT FOR DEGENERATES SITTING IN THEIR CARS SODOMIZING, BOOZING, AND SMOKING. DON'T FORGET TO THROW NAILS EVERYWHERE. NAILS AND HAMMERS GO TOGETHER WELL.

A HAMMER CAN SMASH PEOPLE TOO, ITS AN ULTIMATE WEAPON THAT OUR ANCESTORS WOULD HAVE LOVED TO OWN. WELDING HARDENED STEEL IN HAND, YOU CAN PUNCTURE, CRUSH, AND PULVERIZE THE SKINNY POWER-BOTTOM WHO IS WORKING AT THE SEX SHOP YOU'RE CURRENTLY TURNING IN TO A PARKING LOT WITH A LITTLE BIT OF IRON OXIDE AND ALUMINUM POWDER.

WITH A HAMMER AND NAILS, THE SABOTEUR CAN RETURN "PEOPLE" AND THEIR ESTABLISHMENTS TO THE PLACES THEY BELONG, IN MASS GRAVES AND A GARBAGE DUMP COLLECTIVELY. MAYBE BOTH IN THE GARBAGE DUMP.

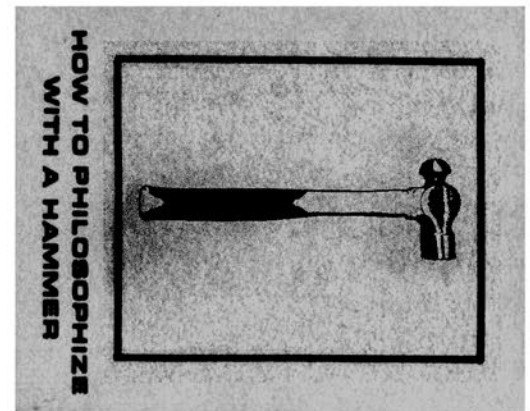

-----UNCONVENTIONAL MEANS-----
MAIL THEM WHITE POWDER, SCENT-FREE LAUNDRY DETERGENT PERHAPS.

BUY SOME RODENT OR FEEDER BUGS FROM A PET STORE AND BREED HUNDREDS OF THEM, AND THEN LET THEM FREE IN YOUR TARGET ESTABLISHMENT.

COMMERCIAL BUSINESSES PAGE 4

STEALING, LOOTING, SCAMMING "RETURNS ARE EASY."

YOU CAN LIE TO AMAZOG AND CHINA, IT'S NOT EVEN ILLEGAL.

DESTROY THINGS ON PURPOSE AND RETURN THEM, SHIPPING IS ON THE STOREFRONT AND NOT ON YOU 99% OF THE TIME."

THOUGH NOT TERRIBLY PAINFUL FOR CORPORATE ENTITIES, THE FOLLOWING CAN SOMETIMES PROVIDE GAIN FOR THE SABOTEUR. PERHAPS THE MONEY SAVED ON THESE GOODS CAN BE SAVED FOR TRUE DESTRUCTION OF THE MANY TARGETS OUTLINED.

MUCH LIKE SHOPLIFTING, SCAMMING AND LYING TO THESE COMPANIES IS BASED BUT ACTUALLY LESS OF A RISK.

BE CREATIVE WHILE DOING THESE THINGS. ALWAYS WEAR A COVID MASK. NEVER SIGN YOUR REAL NAME. DO EVERYTHING IN CASH. HERE ARE SOME EASY POINTERS:

AS DISCUSSED ELSEWHERE IN THIS BOOK, ONE CAN PURCHASE EXTERNAL HARDDRIVES, REPLACE THE INTERNAL DRIVE WITH AN OLD ONE, AND RETURN IT, CLAIMING IT DOESN'T WORK. LOOK ONLINE TO VIEW DISASSEMBLY VIDEOS OF THE EXTERNAL HDD BEFORE PURCHASING TO ENSURE YOUR DONOR DRIVE IS THE SAME SIZE. FORMAT EXCESSIVELY, OR EVEN BREAK THE DONOR DRIVE. DO NOT TRY THIS WITH COMPUTER STORES WHO KNOW WHAT THEY'RE DOING, KEEP TO WALMART, AMAZON, AND SIMILAR.

BUY NON-WORKING OR BOOTLEG SD OR MICRO SD CARDS FROM ONLINE CHINESE RETAILERS THAT AESTHETICALLY MATCH THE EXPENSIVE ONES IN YOUR LOCAL WALMART. BUY THE REAL ONES, AND RETURN THE BROKEN ONES.

BUY PHONES AND BRICK THEM, THEN RETURN THEM. FOR INFO ON HOW TO EASILY BRICK A PHONE RESEARCH: CUSTOM ROM, FLASHING ROM, RECOVERY MODE ANDROID, DOWNLOAD MODE ANDROID AND JUST HAVE FUN, HALF FOLLOW GUIDES, AND TORTURE THE KOREAN INSTAGRAM MACHINE IN YOUR HANDS.

BUY HUNDREDS OF DOLLARS OF GOODS FROM AMAZOG AND SIMPLY RETURN THEM WITHOUT HAVING EVER OPENED THE PACKAGING. CLAIM ANYTHING.

PURCHASE THINGS AND CLAIM THEY NEVER SHOWED UP. THREATEN THE GOOKS

WITH A BAD REVIEW EVEN THOUGH IT'S AN AMAZOG-RELATED ISSUE FOR SUCCESS.

UBEREATS, DOORDASH, INSTACART, GRUBHUB, CHOWNOW, AND A HANDFUL OF OTHER DELIVERY SERVICES CAN BE ABUSED BY CLAIMING THE GOODS WHICH ARRIVED WERE WRONG IN SOME WAY. CLAIM YOU RECEIVED THE WRONG FOOD, OR QUANTITY FOR AN ITEM. MOST DRIVERS FOR THESE SERVICES ARE NON-WHITES AND DESERVE THE TROUBLE THEY'LL BE IN FOR DOING NOTHING WRONG.

THE SAME SERVICES ALL LIKELY ACCEPT PAYPAL AS A PAYMENT METHOD, AS DO MANY CHAIN FAST-FOOD RESTAURANTS. BUY A LARGE ORDER AND USE PAYPAL. MAKE A CLAIM WITH PAYPAL THAT THE COMPANY DID NOT DELIVER THE GOODS IN A TIMELY MANNER, THAT THE FOOD WAS COLD, COOKED WRONG, ETC. IN MANY CASES THESE COMPANIES GET THOUSANDS OF EMAILS PER DAY ABOUT CLAIMS WHICH DON'T GET CHECKED, OR WHICH GET DUMPED IN A JUNK FOLDER. THIS WILL LEAD TO A WEEK OR TWO RETURN OF YOUR CASH WHEN THE CASE DEFAULTS IN YOUR FAVOUR. THEN DUMP THE FOOD AND NEVER EAT ANYTHING FROM A FAST FOOD RESTAURANT.

AFTER GROCERY SHOPPING, LOOK UP WHICH COMPANIES ARE WOMEN OR BLACK OWNED AND CALL THEIR CUSTOMER SERVICE LINES TO COMPLAIN THAT A PRODUCT YOU PURCHASED WASN'T FIT FOR CONSUMPTION, OR WAS PRIMARILY EMPTY. USE A BURNER PHONE NUMBER, NAME, AND EMAIL EVERY TIME. THIS RESULTS IN COMPANIES HANDING OUT COUPONS TO OBTAIN FREE PRODUCTS AND 99% OF THE TIME THEY DON'T CARE ABOUT SEEING THE PRODUCT.

GO TO ANY POPULAR SANDWICH-CHAIN AND CLAIM YOUR ORDER WAS WRONGED IN SOME WAY. DUE TO THE ALLEGED PANDEMIC AFFECTING EVERYONE'S LIVES, MOST COMPANIES WILL NOT AND CANNOT TAKE THE FOOD CONTAINER BACK FROM YOU AND WILL SIMPLY PROVIDE ANOTHER SERVING.

GO TO THOSE SAME SANDWICH CHAINS, ESPECIALLY WHERE NON-WHITES ARE WORKING AND GET A LARGE SANDWICH MADE WITH THE PREMIUM/EXTRA CHEESE, THE BEST MEAT, AND WHATEVER ELSE COSTS MONEY. THEN WHEN IT COMES TIME TO PAY AT THE END OF THE COUNTER, CLAIM YOU DIDN'T UNDERSTAND THAT THIS OR THAT WOULD HAVE COST MORE MONEY, CLAIM YOU DON'T EVEN HAVE THE MONEY TO PAY FOR IT. THESE COMPANIES WOULD RATHER DROP THEIR PRICE AND HAGGLE WITH YOU AND SELL THEIR PRODUCT FOR THE SAME PRICE THEY MADE IT AT THAN TO LOSE ALL OF IT FOR NOTHING. I'VE SEEN \$30 HEAPING SUBS GO FOR \$8 WITH THIS METHOD. DUMP THE SUB ON THE GROUND BEFORE YOU LEAVE THE STORE AND ASK FOR ANOTHER. NEVER EAT THIS GARBAGE, ALTERNATIVELY JUST WALK OUT BEFORE GETTING TO THE PAYMENT COUNTER.

PROCURE A STARBUCKS CUP OFF THE SIDEALK OR OFF THE TOP OF A GARBAGE CAN IN PUBLIC AND WALK IN TO A BUSY STARBUCKS. CLAIM YOU JUST BOUGHT THIS DRINK 5 MINUTES AGO AND WHEN YOU GOT IN YOUR CAR, YOUR 8 YEAR OLD KICKED OR DROPPED IT BY MISTAKE, CAUSING A HUGE MESS. WITHOUT EVEN HAVING TO ASK FOR ANOTHER, THE EMPLOYEES WILL 99% OF THE TIME OFFER TO MAKE ANOTHER. DROP IT ON THE FLOOR AS HARD AS YOU CAN ON THE WAY OUT, BECAUSE YOU SHOULD NEVER DRINK THEIR POISON.

GO TO THE BANK AT PEAK TIME WITH 3 FRIENDS AND OCCUPY ALL 4 TELLER STATIONS. TAKE OUT \$5 EACH, AND WHEN THE TELLER ASKS IF YOU NEED ANYTHING ELSE, SIMPLY TELL HER YOU WOULD LIKE TO DEPOSIT THE \$5 SHE JUST HANDED YOU. DO THIS REPEATEDLY. IF SHE ASKS IF YOU WANT THE RECEIPT, GET MAD AT HER AND SAY YOU DON'T, THEN NEXT RECEIPT CLAIM YOU DO WANT IT, AND GET MAD AT HER AGAIN. DO THIS WHILE WEARING EXTREMELY MUD AND CLAY COVERED BOOTS AND WET PAINT ALL OVER YOUR SHIRT AND PANTS, SO THAT WHEN YOU LEAN ON THE COUNTER, YOU GET PAINT ALL OVER IT. REASSURE THE TELLERS THAT IT IS SIMPLE WATERBASED PAINT.

LEAVE BAD GOOGLE AND YELP REVIEWS ON ANY NON-WHITE OR LGBT-FRIENDLY COMPANY YOU SEE WITHOUT EVEN GOING IN. IT DOESN'T MATTER IF THIS ONE IS A SMALL BUSINESS, THEY DESERVE IT. CREATE RUMOURS ONLINE FOR Q-FAGS THAT THESE BUSINESSES ARE ABUSING CHILDREN IN THE BASEMENT.

COMMUNICATIONS

TAKE AWAY THEIR ABILITY TO SPEAK OR LISTEN

07

HISTORY

COMMUNICATIONS HAVE BEEN AN ESSENTIAL PART OF EVERY BATTLEFIELD SINCE THE BEGINNING OF TIME.

THE MENTALITY IS THE SAME WITHIN THE SABOTEURS WHO WERE DELIBERATELY CUTTING PHYSICAL COMMUNICATIONS LINES IN WORLD WAR 1, TO THE LATE NIGHT MODERN SABOTEUR BREAKING FIBER OPTIC CABLES IN 2022.

BREAKING THE ENEMY'S ABILITY TO COMMUNICATE HAS ALWAYS BEEN OF HIGH IMPORTANCE. SINCE THOSE DAYS OVER 100 YEARS AGO, COMMUNICATIONS NETWORKS HAVE GOTTEN LARGER, BUT HAVEN'T ALWAYS BECOME MORE ROBUST. JUST LIKE THE DAYS OF OLD, THE WORK OF A SABOTEUR IS ALL THAT IS NEEDED TO KEEP OUR ENEMIES IN THE DARK AND UNSURE OF WHAT COULD BE HAPPENING AROUND THEM.

THE SABOTEUR MAKES HISTORY.

IMPACT

THE DESTRUCTION OF A MODERN COMMUNICATIONS NETWORK (BE IT THE INTERNET, RADIO, SATELLITE, OR ANY OTHER MEANS) CREATES A LITTLE DARK AGE WHERE THE SABOTEUR CAN COMMIT TO EVEN GREATER DEEDS AGAINST HIS TARGETS.

THE ENFORCERS OF FALSEHOOD, THE POLICE, CANNOT BE NOTIFIED TO THE SCENE OF SABOTAGE, THEFT, OR ATTACK IF THE COMMUNICATIONS LINES ARE DOWN.

WITH THESE THINGS IN MIND, THE SABOTEUR SHOULD CONSIDER THAT HE OR SHE HAS A MUCH LARGER WINDOW OF OPPORTUNITY TO IMPOSE IMPACT ONCE THIS TYPE OF TARGET HAS BEEN SHATTERED.

ONCE THESE NETWORKS HAVE BEEN BROKEN ONCE, IT WOULD BE WISE FOR THE SABOTEUR TO CONSIDER THAT THEY WILL BE HARDIER THE NEXT TIME HE OR SHE DESIRES TO BREAK THEM AGAIN.

CONSIDERATIONS

NOT ALL COMMUNICATIONS NETWORKS RELY ON THE ELECTRICAL GRID, AND MANY WILL STILL OPERATE EVEN WHEN THE POWER IS CUT.

EACH TYPE OF COMMS EQUIPMENT HAVE PLACES WHERE THEY SHINE, AND PLACES WHERE THEY DON'T.

IF PRIMARY COMMUNICATIONS VIA THE INTERNET/DIGITAL MEANS ARE KNOCKED DOWN, MANY ADVERSARIES OF THE SABOTEUR WILL FALL BACK ON ANALOG MEANS; IF THE POLICE CANNOT USE THEIR ENCRYPTED DMR RADIOS, THEY WILL FALL BACK ON THEIR UHF OR VHF BANDS.

SABOTAGING THE INTERNET ALONE FOR AN AREA WOULD KNOCK OUT PRIMARY COMMS FOR NEARLY ALL OF THE PEOPLE WITHIN THE AREA.

THE SABOTEUR SHOULD ENSURE HE OR SHE HAS SET UP ALTERNATIVE LINES OF COMMUNICATION VIA MESH NETWORKING OR SIMILAR BEFORE DESTROYING THE STABLE COMMUNICATIONS NETWORKS PRESENT IN HIS OR HER AREA.

COMMUNICATIONS

PAGE 2

PROCEDURES (CELLULAR)

SEE HEADER 2: CELL TOWERS.

PROCEDURES (FIBER)

FIBER OPTIC CABLES ONLY NEED TO BE BENT IN ONE PLACE AT A RELATIVELY HARSH ANGLE TO BREAK THE INNER WORKINGS, FORCING WORKERS TO MEND OR REPLACE ENTIRE LONG RUNS OF CABLE BECAUSE OF THIS. THIS PROCESS IS SILENT AND CAN BE DONE WITH NO TOOLS (EXCEPT IN SOME CASES A LADDER). AN OPPORTUNE TIME TO CAUSE THIS DAMAGE IS WHEN THE CABLES ARE ON CONSTRUCTION SITES BUT NOT INSTALLED YET, THEY'RE TYPICALLY SITTING IN ROLLS WITH A LARGE DIAMETER.

PROCEDURES (JUNCTION)

ABOVE GROUND JUNCTION BOXES USED TO MANAGE TELEPHONE LINES GENERALLY GO UNREPORTED FOR WEEKS AFTER BEING DAMAGED BECAUSE OF HOW INFREQUENTLY THEY'RE BEING USED. IF THE SABOTEUR DESIRES TO DESTROY ONE, HE OR SHE ONLY NEEDS TO APPROACH ONE IN THE NIGHT, OPEN THE BOX BY ANY MEANS, THEN EITHER CUT THE WIRES WITH AN INSULATED TOOL, OR LOOSEN OFF MANY OF THE TERMINALS WITH AN INSULATED TOOL.

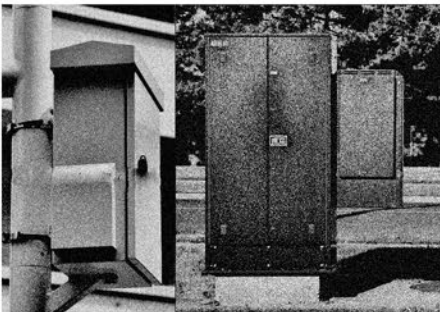

PROCEDURES (SERVERS)

IF THE SABOTEUR HAS ACCESS TO A COMMERCIAL BUILDING HE OR SHE IS WISHING TO AFFECT, THEN THERE IS, SIZE DEPENDING, A SERVER ROOM WHICH CAN BE PHYSICALLY AFFECTED IN AN ARRAY OF PERMANENT OR SEMI-PERMANENT WAYS DEPENDING ON THE SCOPE AND DESIRE OF THE SABOTEUR.

PROCEDURES (SATELLITE)

THE WEAKNESS OF SATELLITE DISHES IS THAT THEY MUST BE ORIENTED, CONSISTENT, AND NOT PERFORATED.

THE SABOTEUR CAN DISABLE OR SERIOUSLY DAMAGE THE ABILITY TO CONDUCT SATELLITE COMMUNICATIONS MERELY BY PERFORATING THE DISHES OR SMASHING THEM ALTOGETHER. IF THE SABOTEUR WISHES TO BE MORE DISCREET ABOUT THE SABOTAGE, THEN HE OR SHE CAN QUIETLY DESTROY OR REMOVE ONLY THE FEED HORN.

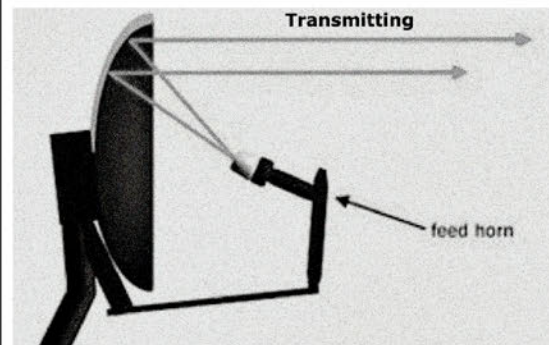

PROCEDURES (UNDERGROUND)

THE MAJORITY OF COMMUNICATIONS HAVE AT LEAST SOME RELIANCE ON UNDERGROUND COMMUNICATIONS LINES, ESPECIALLY WITHIN THE CITIES.

BRIDGES ARE CHOKE POINTS FOR THESE UNDERGROUND COMMS LINES, AS THEY MUST CONVERGE TO REACH OTHER AREAS.

THESE UNDERGROUND TUNNELS CAN BE REACHED THROUGH A CITY'S AQUADUCTS, COLLECTORS, METRO, AND SEWAGE SYSTEMS.

THE COMMS LINES THEMSELVES ARE IN THE FORM OF HARDY CABLES RUNNING THROUGHOUT THESE SYSTEMS AND CAN HAVE LITTLE TO NO SECURITY DEPENDING ON THEIR LOCATION.

MAINTENANCE WORKERS, MOTION DETECTORS, AND FIRE SUPPRESSION SYSTEMS ARE THE MAIN TOOLS IN PLACE TO PREVENT THE SABOTEUR FROM DESTROYING THESE LINES.

IN SOME CASES, THE LOCATION AND ROUTING OF THESE LINES AND THEIR JUNCTIONS CAN BE FOUND IN OLD CITY PLANS ONLINE OR EVEN AT THE SABOTEUR'S

OWN LIBRARY AS A MATTER OF PUBLIC (BUT SOMETIMES OUTDATED) RECORD IN SOME CASES.

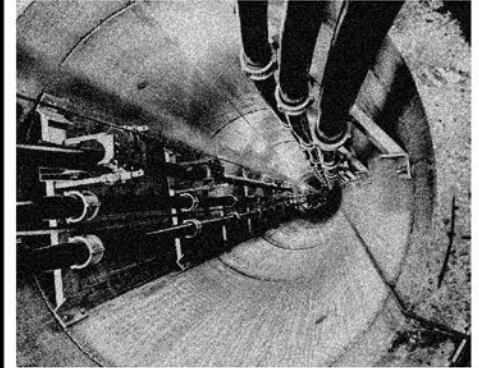

THE SABOTEUR SHOULD FAMILIARIZE HIM OR HERSELF WITH THE TYPES OF CABLE USED IN THEIR COUNTRY, AND WHAT TO LOOK OUT FOR BEFORE SAFELY PROCEEDING.

THERE CAN BE MANY TYPES INCLUDING HIGH VOLTAGE, GAS FILLED, AND/OR OIL FILLED CABLES FOR OTHER PURPOSES; THE DESTRUCTION OF WHICH MAY REQUIRE DIFFERENT CONSIDERATIONS THAN OUTLINED IN THIS GUIDE FOR THE SABOTEUR.

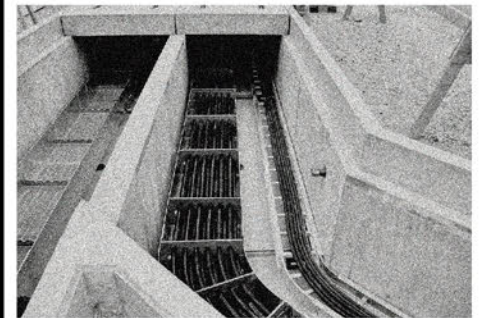

THE SABOTEUR SHOULD FOCUS ON BURNING OUT SECTIONS OF CABLE, WHILE ALWAYS ENSURING AN ESCAPE ROUTE FREE OF FUMES AND SMOKE IS AVAILABLE; ALWAYS LEAVING AS EARLY AS POSSIBLE.

THERMITE IS ANOTHER TOOL WHICH COULD BE USED TO BURN THROUGH THE HEAVY ARRAY OF INSULATORS AND ARMOR COVERING THE CABLES BENEATH.

PRESENT UNDERGROUND AS WELL: JUNCTION BOXES AND SIMILAR TERMINALS FOR THE SABOTEUR.

ELECTRICAL

POWERLINES, TRANSFORMERS, SUB-STATIONS, AND THE GHOST THAT IS ELECTRICITY

08

HISTORY

HISTORICALLY WITHOUT POWER FOR A FEW WEEKS, THE MASSES WILL BAND TOGETHER FOR THE MUTUAL GOOD OF MODERNITY; BUT DURING A LONG-TERM OUTAGE, THE MASSES WILL CRUMPLE AND EAT ONE ANOTHER BETWEEN LOOTING AND KILLING THEIR ENEMIES.

ATTACKING THE GRID IS NO NEW CONCEPT, WITH SOME SIGNIFICANT EXAMPLES BEING THE CU PROJECT CONTROVERSY (LEADING TO THE CREATION OF NEARLY A DOZEN MILITANT ANTI-POWERLINE GROUPS); THE METCALF SNIPER ATTACK (RESULTING IN \$15 MILLION IN DAMAGES); AND MORE RECENTLY TWITTER VIDEOS OF A MEXICAN MAN DRIVING AROUND SHOOTING POLE MOUNTED TRANSFORMERS WITH A GLOCK (IMPRESSIVE LONE-WOLF WORK).

BEFORE THE TIMES WE FIND OURSELVES IN, ATTACKING THE POWER GRID WAS AN EFFECTIVE MEANS OF SABOTAGE IN THE WARS OF OLD TIMES, EFFECTIVE EVEN DURING A PERIOD WHERE PEOPLE WEREN'T AS RELIANT ON TECHNOLOGY AS THEY ARE TODAY.

IMPACT

ELECTRICITY IS THE MAIN SATIATING TOOL THE SYSTEM USES TO KEEP THE MASSES FROM RIOTING.

BY DISABLING ELECTRICITY, A SABOTEUR IS STOPPING EVERYTHING FROM LIFE SUPPORT TO SEX TOYS, THE LOSS OF EITHER WILL DRIVE THE MASSES IN TO PANIC EQUALLY.

IF CHOKE POINTS ARE PROPERLY UTILIZED OR A PLANT ITSELF IS ATTACKED BY THE SABOTEUR, ENTIRE REGIONS CAN BE KNOCKED OUT FOR UP TO MONTHS. THE EFFECTIVENESS OF THIS HEIGHTENED IF A REGION IS ALREADY EXPERIENCING SOME LEVEL OF CHAOS OR LIMITATION.

IF SABOTAGE IS CONDUCTED IN A NON-SPECIFIC AREA DURING TIMES OF PEACE, IT WILL BE PATCHED QUICKLY AND EASILY BY THE SYSTEM'S WORKERS.

WITHOUT POWER OTHER TYPES OF SABOTAGE BECOME VERY POWERFUL AND HARDER TO REPAIR, AS SUCH THE IMPACT OF A DIRECTED OUTAGE COULD EXPONENTIALLY INCREASE THE RESULTS OF A SABOTEUR'S EFFORTS.

CONSIDERATIONS

THE SECURITY STEEPLY HEIGHTENS FROM POWERLINE TO POWER-PLANT, THIS WILL INCLUDE EVERY TYPE OF SECURITY ONE WOULD EXPECT FROM HIGH VALUE TARGETS LIKE THESE.

FOR POWER PLANTS EXPECT THINGS TO BE AS TIGHT AS LIVE MONITORED INFRARED SECURITY CAMERAS, THERMAL IMAGING, MOTION DETECTORS, DRONES, BACK-UP POWER, ARMED SECURITY PERSONNEL, DOGS, BARRED DOORS, AND POSSIBLY EVEN SATELLITE IMAGERY IN THE CASE OF BIGGER PLANTS AND DEPENDING ON WHICH COUNTRY THE PLANT IS IN.

FOR LINES AND SUB-STATIONS SECURITY CAN BE NOTHING, BUT EXPECT AT LEAST CCTV CAMERAS.

ANY SABOTAGE YOU COMMIT, WILL RESULT IN THE AREA BEING CLOSELY COMBED FOR EVIDENCE BY MANY MEANS INCLUDING BY USING DOGS AND TECHNOLOGY TO DISCOVER ANY EVIDENCE AND TO DETERMINE WHO YOU ARE.

FIREFIGHTERS CANNOT FIGHT A LIVE ELECTRICAL FIRE, THE ENTIRE GRID NEEDS TO BE SHUT OFF FIRST.

ELECTRICAL PAGE 2

PROCEDURES (LINES):

AN IDEAL TOOL OF THE POWERLINE SABOTEUR IS AN APPROPRIATE SAWING TOOL.

FOR WOODEN POWER POLES AN ELECTRIC CHAINSAW IS FAVOURABLE AND WILL EASILY CUT THROUGH SAID POLE. IT'S IMPORTANT TO USE AN ELECTRIC CHAINSAW BECAUSE OF THE EXTREMELY REDUCED NOISE VERSUS A TYPICAL FUEL CHAINSAW.

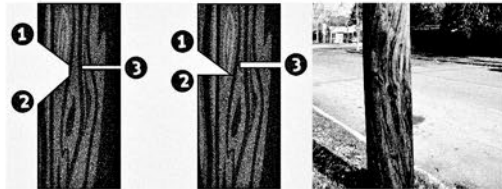

THIN STEEL POWER POLES, OR HIGH VOLTAGE ELECTRICAL TOWERS CAN BE CUT WITH A CORDLESS ELECTRIC GRINDER. IT WON'T BE AS QUIET AS THE CHAINSAW CUTTING IN TO WOOD, BUT IT WILL MAKE QUICK CUTS WHERE THEY'RE NEEDED. THE BIGGER THE BLADE THE BETTER.

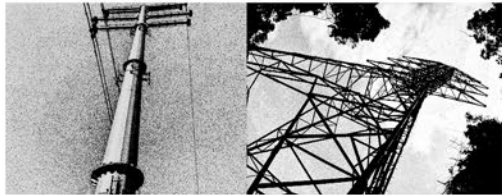

THE SABOTEUR NEEDS TO BE EXTREMELY AWARE OF WHICH WAY THE POLES ARE GOING TO FALL, AND WHERE THEIR WIRES WILL LAND. CAREFULLY THOUGHT OUT NOTCHING AND USEAGE OF NON-CONDUCTIVE ROPES CAN BE USED TO MAKE CONDITIONS MORE IDEAL FOR THE SABOTEUR.

A WAY TO HURT THE LINES WHICH DOES NOT PLACE THE SABOTEUR AT RISK IS TO UTILIZE MYLAR (FOIL COATED) BALLOONS FILLED WITH HELIUM, WHICH WHEN FLOWN IN TO POWERLINES CAUSE EXPLOSIONS, DESTROYING THE LINES AND SOMETIMES TAKING DOWN THE POLES THEMSELVES. MYLAR BALLOONS

ARE CHEAP AND WIDELY AVAILABLE. BUYING THEM WILL NOT AROUSE SUSPICION, BUT WITH YOUR INTENT IN MIND YOU SHOULD ALWAYS PAY IN CASH AND WEAR A MASK WHILE MAKING THE BUY.

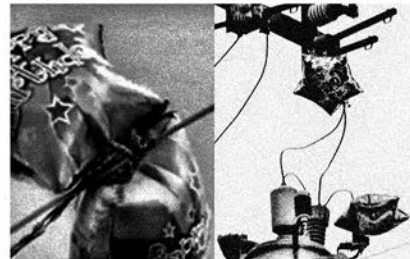

THE LAST METHOD IS DROPPING THINGS ON THE LINES. A SABOTEUR COULD INTENTIONALLY FELL A TREE OR IT'S BRANCHES ON TO THE LINES IN HOPES OF BREAKING THEM, BUT PRECAUTION IS TO BE TAKEN AS WITH CUTTING THE POLES DOWN THEMSELVES.

PROCEDURES (TRANSFORMERS):

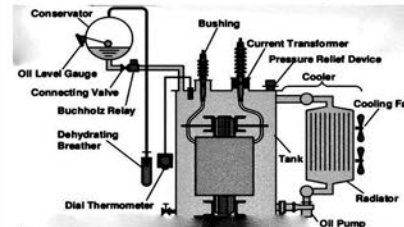

TRANSFORMERS ARE THE LARGE USUALLY MATTE GRAY CYLINDERS ATTACHED TO POLES, OR ON THEIR OWN PLATFORM ATTACHED TO THE LINES (AND OFTEN IN A SMALL GROUP) AND ARE IMPORTANT PIECES OF AN ELECTRICAL GRID USED FOR THE TRANSMISSION, DISTRIBUTION OF POWER, AND TO INCREASE OR DECREASE VOLTAGES.

THEY ARE OFTEN FILLED WITH A HIGHLY REFINED COOLING MINERAL OIL, WHICH, ONCE DRAINED WILL CAUSE THE TRANSFORMER TO EVENTUALLY

FAIL DUE TO AN ACCUMULATION OF HEAT, LEADING TO POSSIBLE EXPLOSION. NOTE THAT DURING AND AFTER THE DESTRUCTION OF TRANSFORMERS, THE NEARBY WIRES WILL ALSO BURN. SPARKS WILL FLY, ARCS WILL GENERATE, AND TOXIC SMOKE WILL FILL THE AREA. THE ENTIRE PROCESS IS VERY DANGEROUS FOR THE SABOTEUR, AND HE OR SHE SHOULD NOT BE WITHIN PROXIMITY OF ANY OF IT. THE MINERAL OILS WHICH SPILL OUT ARE HIGHLY FLAMMABLE, AND CAN EVENTUALLY CATCH FIRE BURNING AREAS OUT ENTIRELY.



AS WITH CELL TOWER SABOTAGE, THE SABOTEUR SHOULD BECOME FAMILIAR WITH HIS OW HER OWN SHOOTING ABILITIES AND BUILD AN IMAGE REPRESENTING HIS OR HER OPERATION RADIUS AS SHOWN BELOW:



ONCE THE OPERATION RADIUS HAS BEEN DETERMINED, THE SABOTEUR CAN SAFELY PICK A FIRING LOCATION.

PARK A SAFE DISTANCE AWAY FROM THE FIRING POSITION AND NAVIGATE THERE BY MEANS OF WALKING, CYCLING,

ELECTRICAL PAGE 3

TRANSFORMERS CONT:
 OR OFF-ROAD VEHICLE. THE FIRING POSITION WILL LIKELY BE DETERMINED BY AUTHORITIES, SO IT'S OF UTMOST IMPORTANCE THAT THE SABOTEUR TAKE ALL MEASURES TO CONCEAL THEIR IDENTITY AND PREVENT THE CREATION OF EVIDENCE.

IF DESIRED, A SABOTEUR CAN HOST THEIR OWN DRY-RUN EXERCISE, WHEREBY THEY CHOOSE AN UNRELATED TARGET AND TIME THEMSELVES PARKING NEARBY, APPROACHING THE TARGET, SIMULATING SABOTAGE, HURRYING BACK TO THEIR VEHICLE, THEN MAKING THEIR ESCAPE. THIS CAN BE DONE LEGALLY, OR THE SABOTEUR CAN EVEN DO THIS WITH LOWER LEVEL FORMS OF ACTION LIKE GRAFFITI OR VANDALISM.

THE SABOTEUR MUST WEAR THE SAME WEIGHTED KIT THEY PLAN TO WEAR ON THE NIGHTS OF THEIR REAL SABOTAGE FOR THESE TRAINING EXERCISES TO BE EFFECTIVE TRAINING AND MEASUREMENTS OF ABILITY. IF THE SABOTEUR DESIRES TO REMAIN LEGAL WITHOUT CARRYING A FIREARM, THEN THE SAME HOLSTER WITH SOME FORM OF WEIGHT IN IT SHOULD BE WORN.

PROCEDURES (SUBSTATION):
 SUBSTATIONS ARE A PILLAR OF THE ELECTRICAL GRID, RESPONSIBLE FOR DISTRIBUTION, TRANSMISSION, COLLECTION, SWITCHING, AND CONVERSATION DEPENDING ON TYPE.

Way: Sub-station (755748424)
 Version #3
 Self-report of Electrical County

Tags

activity	West Nyack
addr:housenumber	208
addr:postcode	09984
addr:street	NY
addr:street	Route 55
amenity	Electric station
building	yes
name	Sub station
highway:transportation	ROAD
operator	West Nyack

Nodes

- 1 nodes
- 755748424
- 755748424
- 755748424
- 755748424

SUBSTATIONS ARE PUBLICALLY INDEXED AND GENERALLY EASY TO FIND WITH ANY MAP SERVICE. SOME SERVICES WILL EVEN PROVIDE ADDITIONAL INFORMATION ABOUT A SUBSTATION. GOOGLE STREET VIEW SHOULD BE UTILIZED.

A SABOTEUR SHOULD AIM FOR SPECIFIC TARGETS WHILE SHOOTING AT SUBSTATIONS. THE BREAKER IS ONE SUCH TARGET, ITSELF BEING A GIANT SOPHISTICATED FUSE FOR DEALING WITH LARGE AMOUNTS OF VOLTAGE WHEN THINGS GO WRONG ELSEWHERE IN THE POWER GRID. THEY RELY ON FILLING A CHAMBER WITH A NON-CONDUCTIVE OIL OR GAS IN ORDER TO CUT CURRENT OFF. THEY WON'T BE ABLE TO FUNCTION WITHOUT THEIR OIL. AND CAN CATCH FIRE.



SUBSTATIONS WILL UTILIZE FIRE RESISTANT WALLING BETWEEN INSTRUMENTS. EVERYTHING IN THE SUBSTATION WILL HAVE PROPER GROUNDING AS WELL. AIM FOR DAMAGE TO RESULT NOT FROM ELECTRICAL FIRES OR FAULTING, BUT FROM OVERHEATING AND OIL FIRES.

RADIATORS AND COOLING FANS, PICTURED BELOW, SHOULD ALSO BE TARGETTED.

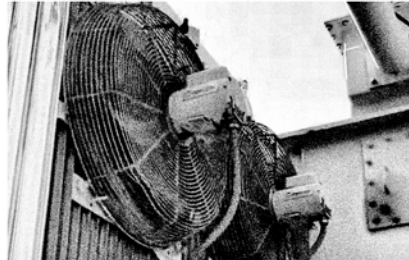

OTHER TARGETS INCLUDE THE OIL PUMPS, OIL CONSERVATOR TANK, AND ELECTRONIC CONTROLS. IDEALLY THE SABOTEUR WILL BE ABLE TO TARGET ALL OF THESE COMPONENTS IN A CONCISE AND ACCURATE MANNER USING AN APPROPRIATE CALIBRE (7.62x51 OR LARGER).

PROCEDURES (PLANTS):
 IT IS NOT SUGGESTED DURING TIMES OF PEACE TO ATTEMPT TO SABOTAGE POWERPLANTS THEMSELVES UNLESS A SABOTEUR IS HIGHLY EXPERIENCED, IN WHICH CASE HE OR SHE WOULD LIKELY NOT HAVE NEEDED THESE GUIDELINES IN THE FIRST PLACE.

PROCEDURES (CHOKE POINTS):
 THE SABOTEUR SHOULD BECOME FAMILIAR WITH ELECTRICAL CHOKE POINTS. SOME SMALLER CITIES WITHOUT THEIR OWN POWER GENERATION OFTEN HAVE ONLY ONE ROUTE FOR POWER TO ENTER THEM, SOME COUNTIES OFTEN HAVE ONLY A FEW MORE. MAPS OF THE POWER GRID CAN BE FOUND AND STUDIED ONLINE.

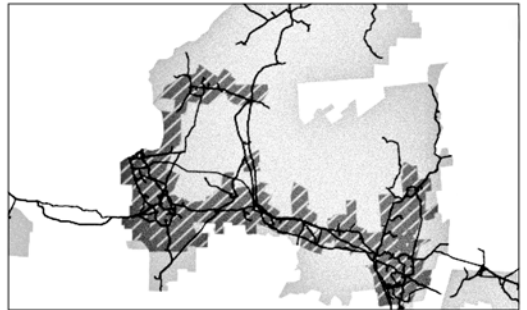

THE SABOTEUR SHOULD MAKE FOCUS ON RURAL LINES, TRANSFORMERS, AND SUBSTATIONS WHILE UTILIZING OFF-ROAD VEHICLES SUCH AS ATVS AND DIRTBIKES FOR THE MOST EFFECTIVE ATTACKS. IF COORDINATED, LARGE NETWORKS COULD BE TAKEN DOWN.

TWO SABOTEURS COULD UTILIZE A POWERLINE MAP AND DEVELOP THEIR OWN PARALLEL ROUTES, WHEREBY, POWER COULD BE REMOVED FROM MANY REGIONS IN THE COURSE OF A FEW HOURS IF CHOKEPOINTS WERE TO BE ACKNOWLEDGED AND UTILIZED.

STUDYING:
 THE SABOTEUR SHOULD BECOME FAMILIAR WITH THE EQUIPMENT HE OR SHE WISHES TO ATTACK. DIAGRAMS, STUDIES, AND EXPLANATORY VIDEOS AT LEAST SHOULD BE USED TO PRIME THE SABOTEUR'S MIND WITH KNOWLEDGE. NO ONE GUIDE CAN DIRECT THE SABOTEUR THROUGH THEIR ATTACK. MANY VARIABLES ARE PRESENT AND GUIDES LIKE THESE CAN ONLY ACT TO IMPOSE A TACTICAL WAY OF THINKING IN THE SABOTEUR'S MIND.

ELECTRICAL PAGE 4

STUDYING CONT:

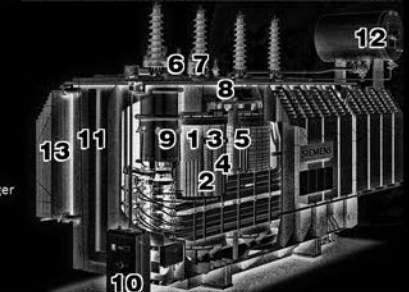
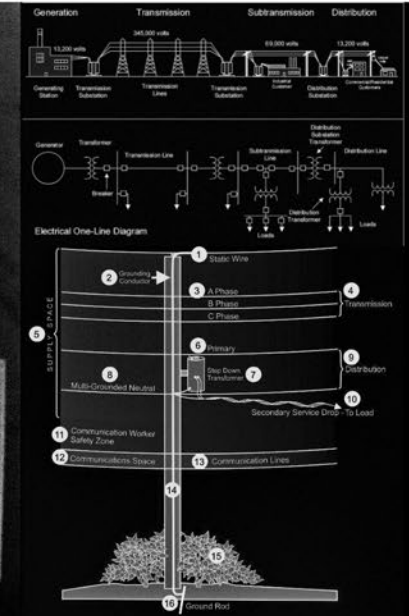
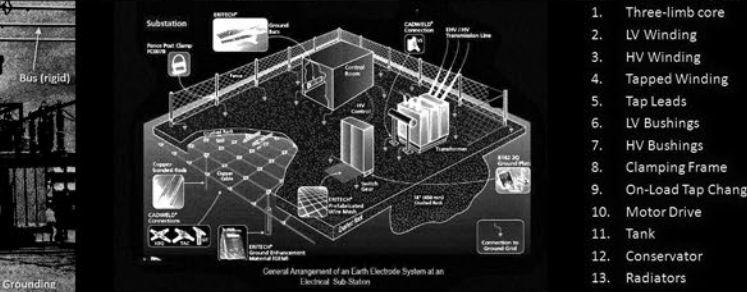
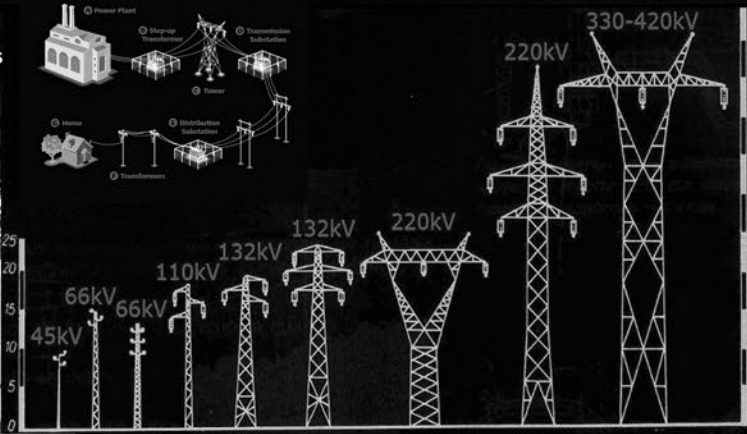
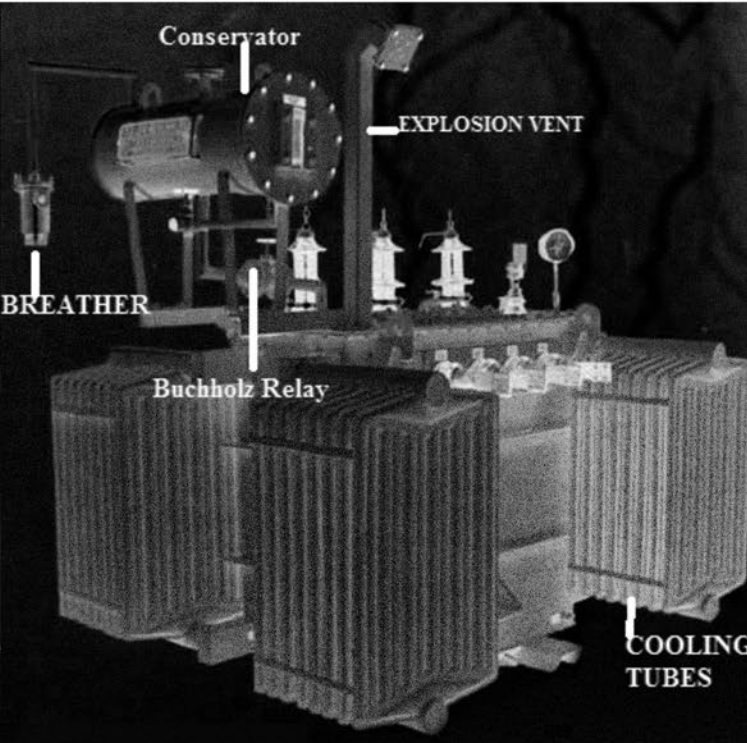
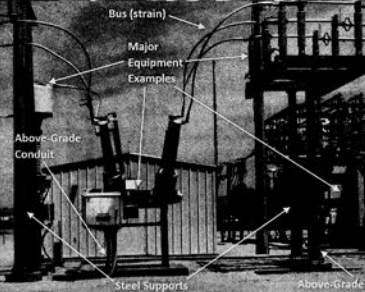
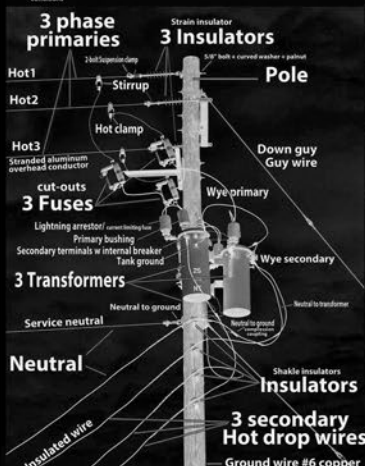
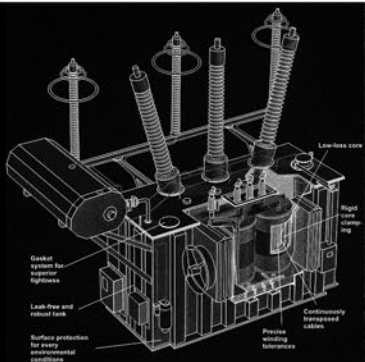

1. Three-limb core
2. LV Winding
3. HV Winding
4. Tapped Winding
5. Tap Leads
6. LV Bushings
7. HV Bushings
8. Clamping Frame
9. On-Load Tap Changer
10. Motor Drive
11. Tank
12. Conservator
13. Radiators

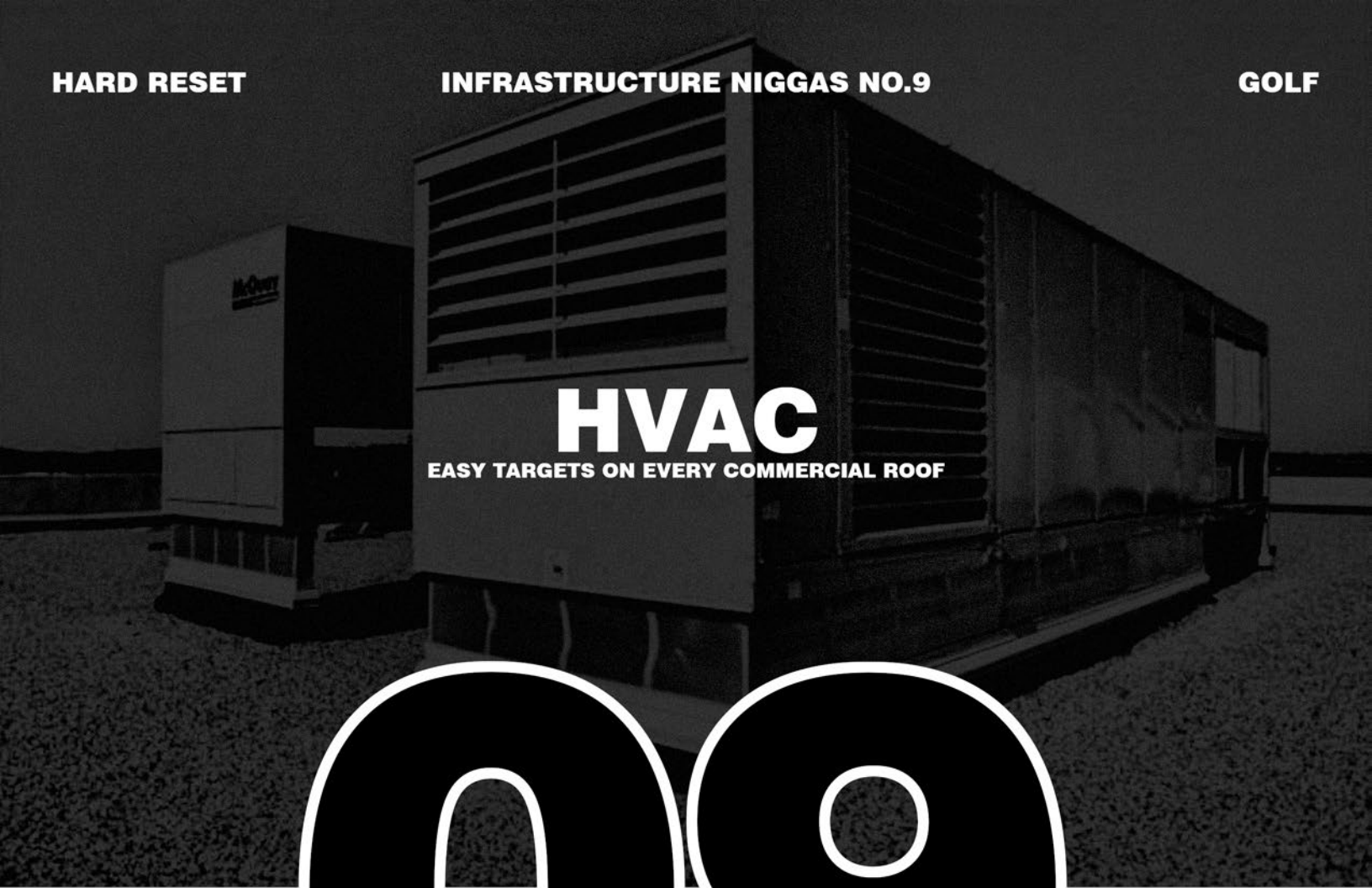

HVAC

EASY TARGETS ON EVERY COMMERCIAL ROOF

09

HISTORY

A SEARCH IN TO ANY CITY, OR TOWN, FOLLOWED BY "VANDALISM" WILL RETURN RESULTS THAT REFLECT THE METHODS OUTLINED IN THIS GUIDE.

PEOPLE HAVE BEEN DESTROYING THINGS ON TOP OF BUILDINGS FOR FUN SINCE THEY CAME ABOUT. TEENAGERS PARTICULARLY LOVE TO CLIMB AND DESTROY.

IT COULD BE SAID THAT THIS CHILD-LIKE SPIRIT LIVES ON THROUGH THE SABOTEUR AS HE COSTS HIS LIBRARY THOUSANDS AFTER HOSTING A CHILD DRAG EVENT, OR BY COSTING THE LOCAL UNDERGROUND MASSAGE PARLOR THOUSANDS FOR ALLOWING DEPRAVED PROSTITUTION TO BE PRESENT WITHIN THE SABOTGEUR'S COMMUNITY.

CONSIDERATIONS

WITHOUT ITS AIR CONDITIONING, ONE CAN SURELY EXPECT TO SHUT DOWN MOST DEGENERATE BUSINESSES FOR MORE THAN A FEW NIGHTS, PARTICULARLY CLUBS, STRIP CLUBS, OR BARS.

LARGE MOSQUES, SYNAGOGUES, TEMPLES, AND THE LIKE COULD ALSO BE AFFECTED, WITH SOME OF THEIR HVAC EQUIPMENT NOT BEING ON THE ROOF, BUT ON THE GROUND BESIDE THE BUILDINGS.

FORCED AIR SYSTEMS OFTEN UTILIZE SOME OF THE SAME MACHINERY, SO A STRIKE AGAINST THEM WOULD AFFECT HEATING IN THE WINTER, AND COOLING IN THE SUMMER.

AN INVESTIGATION IN TO THE SABOTAGE WOULD LIKELY BE OPENED IF THE SABOTEUR WAS MORE DIRECT IN HIS OR HER APPROACH. AN INVESTIGATION WOULD BE LESS LIKELY IF THE SABOTAGE WAS MADE TO LOOK LIKE POOR MAINTENANCE, OR MADE TO LOOK AS THOUGH IT WAS DONE BY TEENAGERS.

CONSIDERATIONS

STRIKING THIS TYPE OF TARGET IS VERY EASY, AND CAN BE DONE BY AN ARRAY OF UP-CLOSE OR DISTANCED METHODS.

OUTSIDE OF SOME CAMERAS, HVAC COMPONENTS ARE GENERALLY NOT HEAVILY GUARDED ON MOST BUSINESSES.

THE BUSINESS TYPE MAY ALLOW YOU TO MOVE ON THE ROOF WITHOUT WORRYING ABOUT GENERATING TOO MUCH NOISE.

HVAC COMPONENTS HAVE MANY WEAK POINTS, ALLOWING FROM BASIC PRANK-TIER SABOTAGE TO MAKING THE BUILDING DANGEROUS TO INHABIT.

THE SABOTEUR CAN DO A LOT MORE WITH A PROPER TOOLKIT, AND BY FAMILIARIZING HIM OR HERSELF WITH THE SPECIFIC UNIT BEING SABOTAGED.

SEEING REPAIR AND MAINTENANCE TRUCKS OR PEOPLE ON SCENE IN THE FOLLOWING DAYS OR WEEKS MEANS THAT YOU'VE COST YOUR TARGET MONEY - AND THEREFORE YOUR SABOTAGE WAS EFFECTIVE.

HVAC PAGE 2

PROCEDURES (SAFETY)

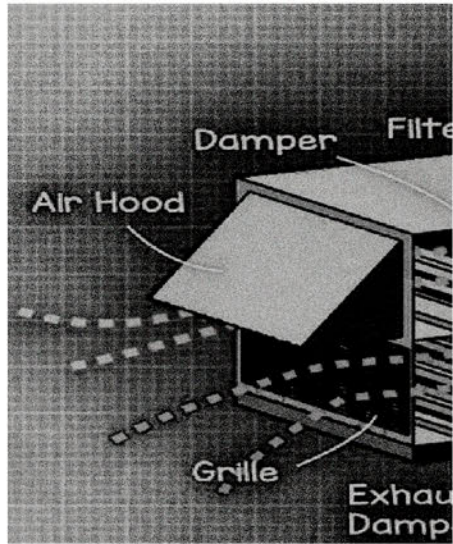

MOST UNITS CONTAIN ELECTRICAL SHUT OFF AND LOCK OUT SWITCHES ON THE OUTSIDE. SELDOM DO THEY HAVE PADLOCKS OR SIMILAR ON THEM, ALLOWING THE SABOTEUR TO SAFELY SHUT MANY TYPES OF UNITS OFF SO THAT SOME TYPES OF SABOTAGE CAN BE CONDUCTED WITH THE HEALTH OF THE SABOTEUR IN MIND.

NO MATTER HOW SAFE THE MACHINE SEEMS, NEVER HANDLE ELECTRICAL COMPONENTS UNLESS YOU KNOW WHAT YOU'RE DOING, AND ALWAYS ASSUME THE FANS CAN ACTIVATE AT ANY TIME.

PROCEDURES (LIGHT)

CRUSHING DOWN MOST OF THE GRILL FLAT SO THAT FLOW IS DAMPENED IS AN EFFECTIVE MEANS OF LIGHT SABOTAGE WHERE THE SABOTEUR WANTS TO HAMPER OR DISABLE THE UNIT TEMPORARILY WITHOUT DRAWING A LOT OF ATTENTION TO THEMSELVES.

THE SABOTEUR CAN ALSO DELIBERATELY LOOSEN AND REMOVE BOLTS AND SCREWS. IF DONE SPARSELY AND WITH BOLTS OR SCREWS LEFT NEAR THE MACHINE, SOME MAINTENANCE WORKERS MAY ASSUME THAT THEY VIBRATED THEMSELVES OUT.

PROCEDURES (MEDIUM)

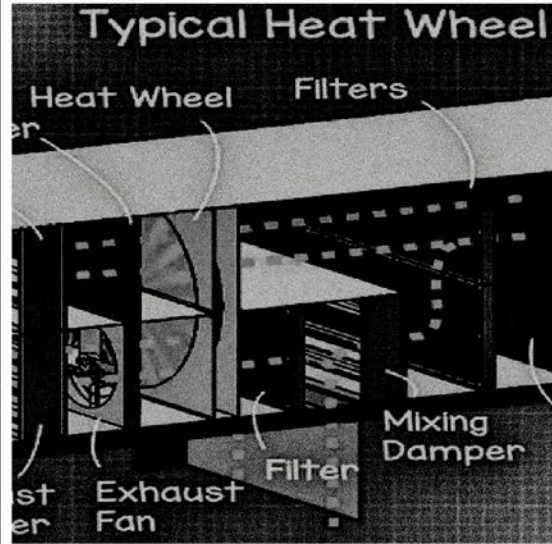

SABOTAGE BY MECHANICAL MEANS AGAINST THE BLADES CAN BE ACHIEVED BY SHUTTING THE MACHINE OFF, ALLOWING IT TO FULLY STOP, THEN PLACING DEBRIS SUCH AS METALLIC RODS THROUGH THE VENTS DOWN IN TO THE BLADES, THEN FLICKING IT BACK ON BEFORE LEAVING THE LOCATION.

DUMPING ROCKS AND DIRT IN THE TOP GENERALLY DOESN'T CAUSE THE SAME DAMAGE THAT METALLIC RODS DO, AS THE MACHINE HAS TIME TO NATURALLY VENT THEM OUT.

AIR CONDITIONERS ALWAYS HAVE A MEANS TO DEAL WITH EXTRA CONDENSATION, AND TYPICALLY HAVE AN EXTERNAL PIPE WHICH WILL DISCHARGE WATER IF THERE'S A CLOG SOMEWHERE ELSE IN THE DRAINAGE SYSTEM. THEY CAN BE EASILY CLOGGED THEMSELVES, OR EVEN TURNED IN WAYS THAT WOULDN'T ALLOW WATER TO EASILY ESCAPE, ALLOWING FOR CONTINUED DAMAGE MONTHS AFTER THE SABOTEUR HAS LEFT.

IF ACCESSIBLE TO THE SABOTEUR, THE BELTS WHICH CONNECT TO THE FAN ARE UNDER GREAT TENSION AND CAN BE DAMAGED BY TRAUMA OR CUT, DISABLING THE UNIT.

STABBING THROUGH COILS AND RADIATORS WITH AN INSULATED TOOL (TO PREVENT ELECTRICAL SHOCK TO THE SABOTEUR) WILL PREVENT THE MACHINE FROM FUNCTIONING EFFICIENTLY OR AT ALL.

PROCEDURES (HEAVY)

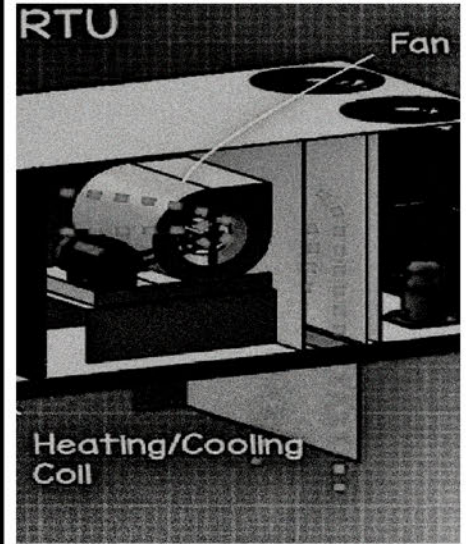

SOME UNITS CONTAIN EXPENSIVE COMPUTERIZED CONTROLLERS WHICH CAN BE SMASHED OR DAMAGED TO PREVENT THE UNITS FROM OPERATING PROPERLY.

MANY UNITS HAVE NATURAL/FOSSIL GAS LEADING IN TO THEM, WHICH CAN BE SABOTAGED TO CAUSE GAS LEAKS OR OUTRIGHT EXPLOSIONS.

THE INSIDE OF AN ELECTRICALLY SHUT OFF UNIT MAKES FOR THE PERFECT FIRE DRUM IF FILLED WITH THE RIGHT KINDS OF SOLVENTS AND ACCELERANTS, WITH MORE DAMAGE POTENTIAL AS PIPES CONTAINING GASSES BEGIN TO BURST DUE TO PRESSURE. UNLESS INDOORS, UNITS WILL NOT HAVE FIRE SUPPRESSION SYSTEMS OF ANY TYPE.

A TOUCH OF THERMITE ON TOP OF A UNIT WOULD BURN ENTIRELY THROUGH ITS WEAK SHEET METAL AND ON TO THE INTERNAL COMPONENTS, CAUSING DESTRUCTION OF THE UNIT AND EVEN GREATER FIRES FOLLOWING THE INITIAL SABOTAGE.

SHOOTING THROUGH THE UNITS FROM A DISTANCE IS FRUITFUL PROVIDED THE SABOTEUR CAN STRIKE COILS, COMPRESSORS, CONTROLLERS, OR ANY OTHER COMPONENTS WHICH WOULD DISABLE THE UNIT.

WHO I AM

A SABOTEUR

10



I HAVE NOT COMMITTED ALL OF THE ACTS DISCUSSED IN THIS GUIDE, BUT IF IT'S IN THE LINEUP THEN I DEFINITELY KNOW SOMEONE WHO HAS, AND CONSULTED THEM HEAVILY BEFORE PUTTING ANYTHING HERE.

I'VE ALWAYS UTILIZED TECHNOLOGY TO PLAN AND PREPARE FOR MY ACTS.

FROM A YOUNG AGE, AND BEFORE I WAS POLITICIZED IN ANY DIRECTION, YOU COULD EXPECT ME TO SMASH BANK WINDOWS FOR NO REASON FRIDAY NIGHT, OR TO CLIMB BUILDINGS AND FIDDLE WITH THE MACHINERY ON TOP SATURDAY. STEALING FROM CONSTRUCTION SITES AND LIVING A GENERALLY FREE LIFE IS WHAT I SPENT MY YOUTH ON.



**WHY DID I MAKE THIS GUIDE?
SO YOU CAN SPEND YOURS DOING THE SAME.**



The average American is 3 missed meals from rioting.

THE HARD RESET:

WHAT DO I DO WITH THE WEIRD GOO THAT IS FORMED WHEN I MIX:	
☺	GASOLINE 1 PART(S)
	MOTOR OIL 1 PART(S)
	POLYSTRENE 2 PART(S)

OR

WHAT DO I DO WITH THE COOL POWDER THAT IS FORMED WHEN I MIX:	
☺	KNO ₃ 3 CUPS
	CHARCOAL 2 CUPS
	SULFUR 1/2 CUP
	WATER 3 CUPS

OR

WHAT DO I DO WITH THE HEAVY POWDER THAT IS FORMED WHEN I MIX:	
☺	IRON OXIDE (RUST) 2.96 PARTS
	ALUMINUM POWDER 1 PARTS

YOU POSITION IT CAREFULLY.

YOU DON'T TELL ANYONE ABOUT IT.

YOU USE IT WISELY.

“God's victory is guaranteed. Ours isn't, and we're neither omnipotent nor omniscient. We're going up against evil so great that it boggles the mind and they're only getting more evil with each passing minute.”

-oscar, a quick middle-book note

*FAGS
GET
SMOKED*



mayhem

RESET

PAGE
121

A BOOK FOR THE PEOPLE WHO WILL DEFINE
THE FUTURE OF OUR WORLD. A BOOK FOR THE
PEOPLE WHO WILL KEEP OUR FLAME ALIVE.



"DIRECT ACTION IS REALLY THE BEST AND MAY BE THE ONLY WAY TO LEARN WHAT IT IS TO BE AN ACCOMPLICE. WE'RE IN A FIGHT, SO BE READY FOR CONFRONTATION AND CONSEQUENCE."

OUR ENEMIES

"EVEN IF GOD DOES NOT SOMEDAY JUDGE US, THEN THOSE FROM BEYOND THE STARS WILL"

UNKNOWN

"IT CAME FROM NAZI GERMANY, A DANGEROUS LITTLE CHEMICAL WEAPON, SARIN, SARIN! IF YOU INHALE THE MYSTERIOUS VAPOR, YOU WILL FALL WITH BLOODY VOMIT FROM YOUR MOUTH."

COMMISSAR TYRANNOUS

FOURTH-GENERATION WARFARE IS DEFINED AS CONFLICTS WHICH INVOLVE THE FOLLOWING ELEMENTS:

- ...COMPLEX AND LONG TERM TERRORISM (TACTIC)
- ...A NON-NATIONAL OR TRANSNATIONAL BASE HIGHLY DECENTRALIZED
- ...A DIRECT ATTACK ON THE ENEMY'S CULTURE, INCLUDING GENOCIDAL ACTS AGAINST CIVILIANS
- ...ALL AVAILABLE PRESSURES ARE USED. POLITICAL, ECONOMIC, SOCIAL AND MILITARY
- ...OCCURS IN LOW-INTENSITY CONFLICT, INVOLVING ACTORS FROM ALL NETWORKS
- ...NON-COMBATANTS ARE TACTICAL DILEMMAS
- ...LACK OF HIERARCHY
- ...SMALL IN SIZE, SPREAD OUT NETWORK OF COMMUNICATION AND FINANCIAL SUPPORT
- ...USE OF INSURGENCY TACTICS AS SUBVERSION, TERRORISM AND GUERRILLA TACTICS
- ...DECENTRALIZED FORCES.

DECLARATION IV

YOU STOP WALKING ON THE ICE. BELOW YOUR FEET;
YOU BEGIN DANCING ON IT INSTEAD

I
PRESENT
I

007-045

II
FUTURE
II

046-084

III
IMPERFECT
III

085-121

IV
PERFECT
IV

122-176

V
FUTURE PERFECT
V

177-237

VI
PLUPERFECT
VI

238-253

DECLARATION IV INFORMATION

BRAVO - 1 PASSAGE
GOLF - 6 PASSAGES
HOTEL - 3 PASSAGES
INDIA - 1 PASSAGE
KILO - 2 PASSAGES
LIMA - 1 PASSAGE
MIKE - 1 PASSAGE
NOVEMBER - 1 PASSAGE
OSCAR - 17 PASSAGES
PAPA - 1 PASSAGE
TANGO - 1 PASSAGE
VICTOR - 1 PASSAGE
WHISKEY - 2 PASSAGES
ZULU - 2 PASSAGES
TOTAL - 40 PASSAGES
60 PAGES

007 046 085 122 177 238

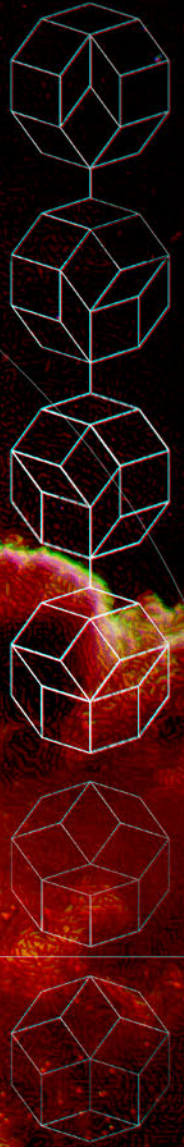

october 2025, haha gottem

HARD
RESET
HARD
R



+ PAGE 123

HR
SUGONDESE PEOPLE'S
LIBERATION FRONT
● ● ● ●

About those tribal fanatics based on the island of Socotra who receive visions from beyond this plane of existence after drinking the sap from the blood tree that more often than not lead them to pick off ships rounding the corner between the Red and Arab seas after passing through the Suez Canal, yeah.

They say that nobody can touch them due to the sheer amount of unique plant species on their island, so they continue to attack ships at random, driving up the cost of using the Suez canal at little cost to themselves.

They say that shipments of arms and ammunition keep reaching them, pointing towards a link between them and the Houthi rebels in Yemen, or perhaps one of the numerous pirate groups from Somalia.

They say that their presence has been more detrimental to global trade than if a ship got stuck in the canal every week.

This story is fictional, of course - but it doesn't have to be. You too possess the ordinary skills required for sabotage, the scale on which you use them is up to you. Some people use them without realizing it - getting drunk on a week night, getting to work late and hungover, getting into an altercation with the diversity hire manager and calling her the nigger word. It's the discipline that it takes to use them consciously that truly separates the wheat from the chaff.

Beyond that, the sky's the limit - literally, you could get a guided surface-to-air missile launcher and target private jets and flights between Tel Aviv and New York if you were enterprising enough. Railways are a safe bet - unguarded, accessible, miles and miles and miles without a single camera watching them. Anything from derailments to simple blockades resulting in hours of delays, it's all up to you. Ever wanted to go to a marina part of a bougie coastal city and sink as many yachts as you could - or commandeer them all to turn them into your private fleet? That would get you quite a lot of clout in your surfer gang. Any little bit helps, so long as it harms the System more than it harms you.

sugondeez haha got em
wait, you wanted a passage
you really want that story, don't you?

A VERY PARTICULAR SET OF SKILLS

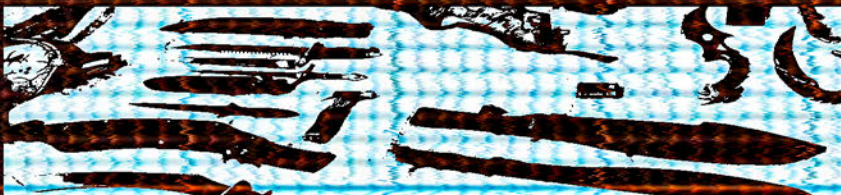
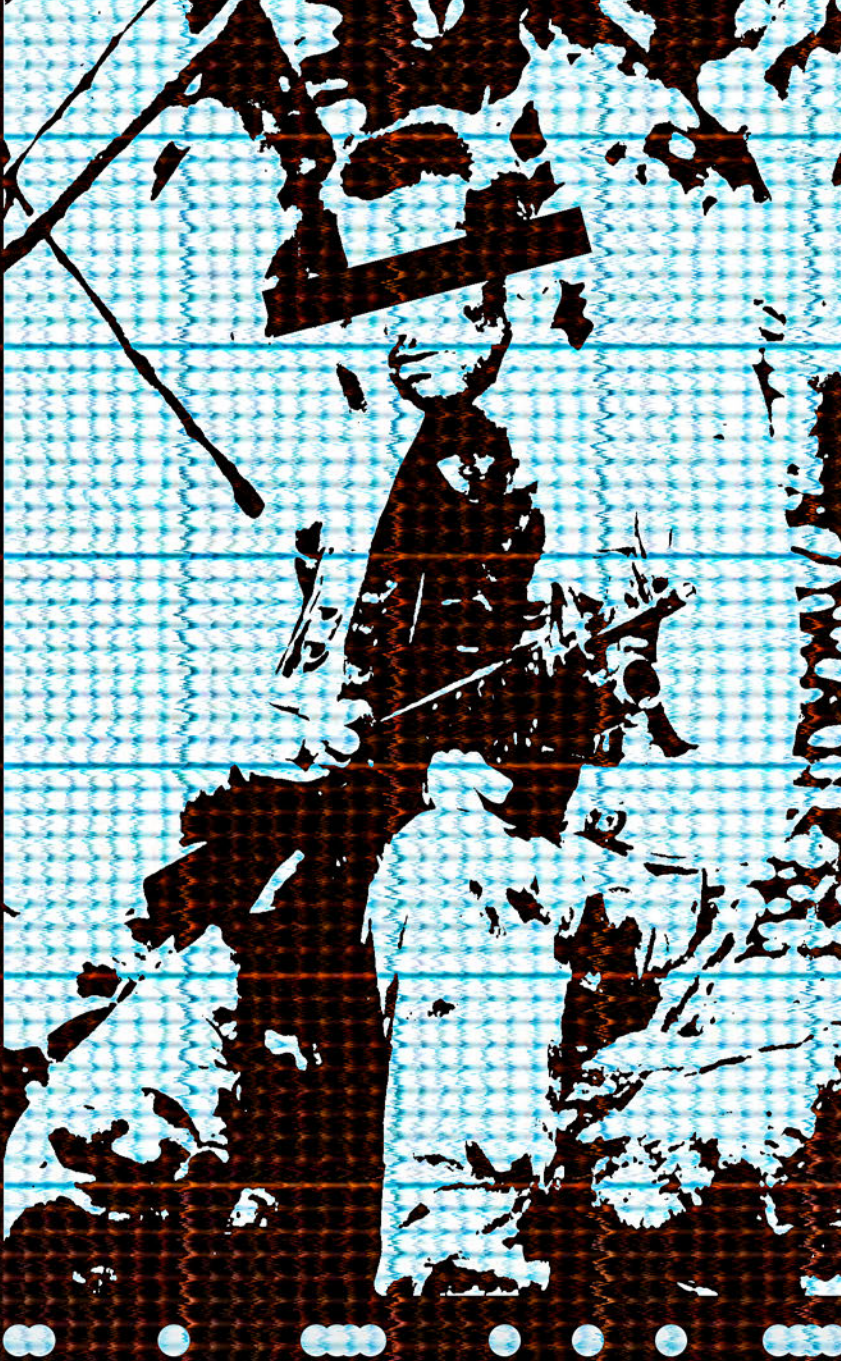

14

STI — KS

88

A SKILL SET IS THE KNOWLEDGE, ABILITIES, AND EXPERIENCE NEEDED TO PERFORM A JOB. SPECIFIC SKILL SET AREAS CAN INCLUDE HUMAN RELATIONS, RESEARCH AND PLANNING, ACCOUNTING, LEADERSHIP, MANAGEMENT, AND COMPUTER SKILLS. REVIEW WHAT A SKILL SET IS, TYPES AND EXAMPLES, AND HOW TO DEVELOP SKILL SETS. MAYBE KILLING SOME JEWS!



HARD RESET

MIKE

A VERY _____
PARTICULAR _____
SET OF _____
SKILLS _____

"WHAT I DO HAVE ARE A VERY PARTICULAR SET OF SKILLS. SKILLS I HAVE ACQUIRED OVER A VERY LONG CAREER. SKILLS THAT MAKE ME A NIGHTMARE FOR PEOPLE LIKE YOU."

WHAT'S STOPPING YOU FROM GETTING A MAINTENANCE OR CUSTODIAL JOB AT YOUR LOCAL [REDACTED] OFFICE, LEARNING THE FLOORPLAN AND HEAD KIKES' SCHEDULES, THEN COMING THROUGH AND REALLY CLEANING THE PLACE UP?

IF YOU WORK IN CONSTRUCTION, YOU'VE GOT ALL THE RIGHT TOOLS AND EQUIPMENT TO DISRUPT, DISMANTLE AND DESTROY. YOU HAVE WELL-WORN, OSHA APPROVED SAFETY GEAR THAT SURELY WON'T RAISE SUSPICION. LIKE MIKE MA SAID, YOU CAN CAUSE A LOT OF DAMAGE WITH AN EXTENSION LADDER AND A GOOD SET OF TOOLS. BECOME THAT DAMAGE. WREAK HAVOC ON YOUR LOCAL URBAN HELLSCAPE.

IF YOU'RE A FIREFIGHTER, YOU KNOW HOW THE MOST DESTRUCTIVE FIRES ARE STARTED, AND WHAT IT TAKES TO PUT THEM OUT. YOU KNOW WHAT FACTORS MAKE FIRES ESPECIALLY DEADLY, OR DIFFICULT TO CONTAIN. YOU KNOW ALL THE TECHNIQUES ARSONISTS USE TO DESTROY EVIDENCE AND GET AWAY WITH THEIR CRIMES.

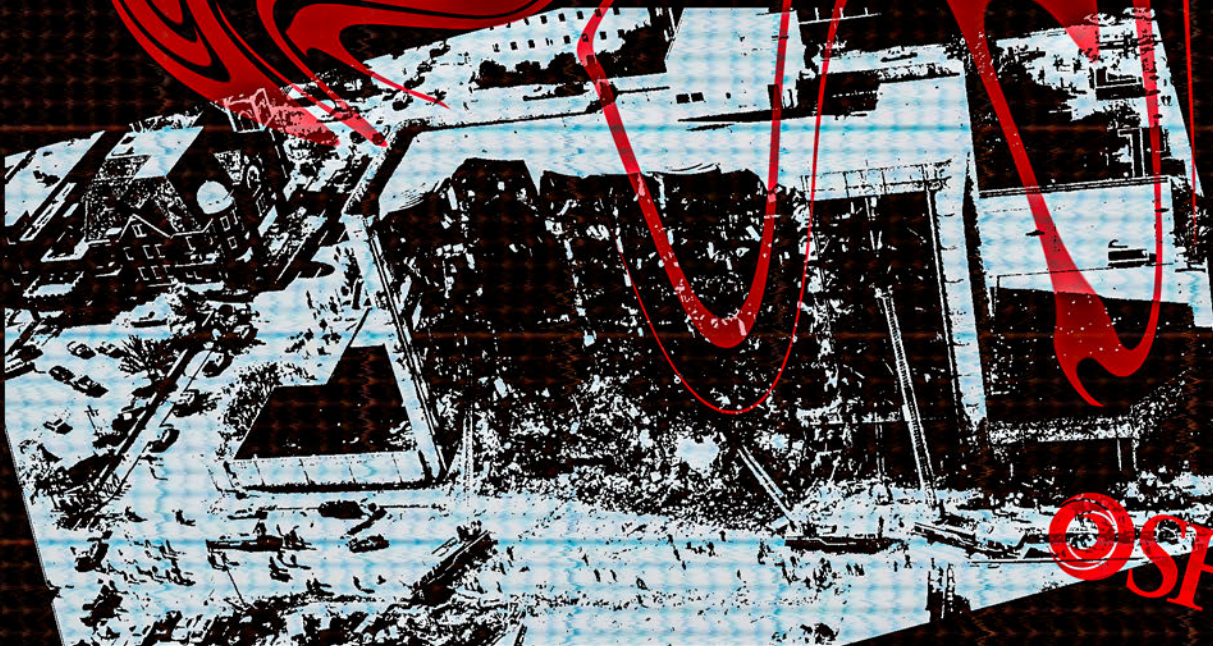

© OSHA®

FORTUNE

IF YOU WORK IN THE ENERGY SECTOR OR IN PUBLIC UTILITIES, YOU HAVE THE KNOWLEDGE AND SKILL NEEDED TO PUT THE POWER OUT FOR A VERY LONG TIME. WHETHER YOU WORK AT A POWER PLANT, WATER OR WASTE TREATMENT PLANT, OR AS A REPAIRMAN OUT IN THE FIELD, YOU KNOW EXACTLY WHAT TO DO. YOU KNOW WHAT VALVES TO OPEN OR CLOSE; WHAT WIRES TO CUT; WHAT PIPES TO DAMAGE. YOU KNOW WHERE THE MANY UNDERGROUND FIBER OPTIC CABLE, SEWER, WATER OR GAS LINES ARE, AND WHERE THEY LEAD. ANYONE COULD TRESPASS ONTO AN ELECTRICAL SUBSTATION, BUT ONLY YOU KNOW WHAT TO DO NEXT. NO MATTER YOUR FIELD, THERE'S CRIPPLING SABOTAGE WITH YOUR NAME ON IT. IF YOU'RE AN UBER DRIVER, OR AN INDEPENDENT CONTRACTOR DELIVERING FOOD, GROCERIES OR OTHER SHIT MOTHERFUCKERS ARE TOO LAZY TO PICK UP THEMSELVES, MAKE YOURSELF AVAILABLE IN TARGET-RICH AREAS. YOU CAN PROBABLY MAKE IT BACK TO YOUR VEHICLE/MOBILE SHOOTING PLATFORM BEFORE THEY ANSWER THE DOOR.

IF YOU WORK FOR A CRT-PUSHING, ANTI-WHITE FORTUNE 500 CORPORATION, YOU HAVE INSIDE KNOWLEDGE OF THE COMPANY'S CORPORATE STRUCTURE AND INNER WORKINGS. YOU HAVE A BADGE TO ACCESS SECURE AREAS, AND LOGIN CREDENTIALS TO ACCESS SECURE SERVERS. YOU HAVE QUARTERLY MEETINGS WITH CORPORATE BIGWIGS, MOST OF WHOM YOU'RE ON CORDIAL TERMS WITH. YOU KNOW WHAT BAR OR RESTAURANT THEY'RE MEETING UP AT TO GRAB A DRINK AFTER WORK - ALL OF THEM, TOGETHER, UNGUARDED AND THEREFORE VULNERABLE TO ATTACK. IF YOU'RE ONE OF THE FEW REMAINING WHITES IN THE HOSPITALITY INDUSTRY, SEEK EMPLOYMENT AT STRATEGIC LOCATIONS, FREQUENTED BY ZOG OFFICIALS, ENFORCERS OR AGENTS. OH, SOME ELECTED TRAITORS ARE IN TOWN FOR A "CONFERENCE"? BECOME A FRIENDLY, NON-THREATENING FACE IN THE BACKGROUND - PERHAPS A CONCIERGE, CHAUFFEUR, HOUSEKEEPER, BELLHOP, SECURITY GUARD, MAINTENANCE OR WAIT STAFF. THE TRAITOR ELITES WOULD LOOK PAST YOU LIKE YOU WEREN'T EVEN THERE. THEY PROBABLY WOULDN'T EVEN NOTICE IF YOU SNUCK UP BEHIND THEM IN ONE OF THE SURVEILLANCE SYSTEMS' BLIND SPOTS - OR EVEN IN THEIR OWN HOTEL ROOM, AFTER LYING IN WAIT - AND TOOK THEM OUT WITH A FEW QUICK ROUNDS FROM A SOUND SUPPRESSED PISTOL.

IF YOU WORK IN THE BELLY OF THE BEAST - IN GOVERNMENT OR POLITICS - YOU HAVE ACCESS TO HIGH PROFILE TARGETS AND THEIR CRONIES, MOST OF WHOM AVOID PUBLIC APPEARANCES LIKE THE PLAGUE. YOU'RE IN A POSITION TO TAKE OUT VERY IMPORTANT PEOPLE. HOW HIGH PROFILE DO YOU WANNA GO? THAT'S UP TO YOU - SUCK UP TO THE RIGHT BLOODSUCKING PARASITES; INVEST ENOUGH TIME AND PATIENCE; THE SKY'S THE LIMIT.

IF YOU'RE A MAILMAN, YOU KNOW THE NAMES AND ADDRESSES OF EVERY TRAITOR AND ENEMY IN YOUR DESIGNATED GEOGRAPHICAL AREA, AND YOU'VE GOT A MASTER KEY. MEMORIZE THEIR LOCATIONS, MAP THEM OUT, STRIKE WHEN THEY LEAST EXPECT IT. SUSPICIOUS PACKAGES ALWAYS GET REPORTED - UNLESS YOU DELIVER THEM. IF YOU WORK IN MINING, BLASTING, EXCAVATING OR DEMOLITION, YOU HAVE ACCESS TO HIGH EXPLOSIVES, DET CORD AND OTHER MATERIALS NEARLY IMPOSSIBLE TO ACQUIRE FOR MOST PEOPLE - AND THOSE MATERIALS CAN BE YOURS IF YOU'RE CLEVER AND DETERMINED ENOUGH, ALL WHILE FLYING UNDER THE SYSTEM'S - AND YOUR BOSS' - RADAR. OR, BETTER YET, WORK YOUR WAY UP FROM APPRENTICE TO FOREMAN; BECOME THE BOSS, AND YOU WON'T HAVE ANY HIGHER-UPS TO ANSWER TO. IF YOU WORK IN AGRICULTURE, YOU PROBABLY HAVE ACCESS TO AN FERTILIZER AND DIESEL FUEL IN MASSIVE QUANTITIES. YOU COULD FOLLOW IN THE FOOTSTEPS OF MCVEIGH AND BREIVIK IF YOU WANTED TO. IF YOUR CAREER GIVES YOU ACCESS TO HAZARDOUS AND/OR RADIOACTIVE MATERIALS, WHAT'S STOPPING YOU FROM BUILDING BIOLOGICAL OR CHEMICAL WEAPONS... OR A DIRTY BOMB? YOU'VE GOT THE EXPERTISE AND PROFESSIONAL EXPERIENCE TO PULL IT OFF SAFELY, SECURELY AND SUCCESSFULLY.

YOU KNOW HOW TO KEEP THE MATERIAL CONTAINED AND HOW TO PROPERLY HANDLE IT; YOU'VE GOT THE RIGHT PPE; YOU COULD GO FROM ACQUISITION TO DETONATION WITHOUT ANY ACCIDENTS. IT'S THE HOLY GRAIL OF TERRORISM, YOU KNOW. YOU'LL MAKE HISTORY. THE COLLATERAL DAMAGE WILL BE HIGH, BUT IT'LL BE WORTH IT. MAKE THEM PAY. ALL OF THEM. FOR DECADES. RADIOACTIVE PARTICLES HAVE A HALF-LIFE, UNLIKE THE TERROR YOU WILL SOW AMONG THE POPULACE, THROUGH ALL STRATA OF THE SYSTEM.



IF YOU GET CREATIVE ENOUGH, THESE PRINCIPLES APPLY TO ALMOST EVERY FIELD OF WORK - WELDERS, ENGINEERS, MECHANICS, ELECTRICIANS, TRUCKERS, HEAVY EQUIPMENT OPERATORS, CYBER SECURITY, COMMS, PRIVATE SECURITY GUARDS (ARMED OR "UNARMED"), HEALTHCARE WORKERS, SOLAR PANEL INSTALLERS, OFFICE WORKERS, CHEMISTS, EMTS, THE LIST GOES ON INDEFINITELY. BUT WHATEVER YOUR FIELD, TAKE THE SAME APPROACH: HONE YOUR CRAFT; SHARPEN YOUR SKILLS; EXCEL, ADVANCE, OUTPERFORM; LEVERAGE YOUR POWER AND ASCEND TO TOP POSITIONS, WHILST COVERTLY TRAINING FOR TRUE ASCENSION. **MAKE YOURSELF INDISPENSABLE TO THE SYSTEM. THEN, DISPENSE WITH THE SYSTEM.** OR, IF YOU'RE A BUDDING YOUNG WIGNAT STILL DECIDING YOUR PATH IN LIFE, CONSIDER THIS PASSAGE "TERRORGRAM CAREER DAY." IT'S IN OUR BLOOD TO PLAN FOR THE FUTURE AND ORIENT OUR LIVES AROUND LONG-TERM GOALS, BUT WE'VE GOT TO SHAKE THE BOOMER MENTALITY OF "PLANNING FOR RETIREMENT."

IF THE SYSTEM'S ANTI-WHITE AGENDA CONTINUES UNIMPEDED, OUR HARD WORK AND SACRIFICE WILL BE IN VAIN ANYWAY. OUR PENSIONS WILL BE SQUANDERED, GIVEN AWAY TO SHITSKIN INVADERS, FERAL NIGGERS, AND FILTHY RACE TRAITOR SINGLE MOTHERS WITH HORDES OF MYSTERY MEAT MONGREL CHILDREN. RATHER THAN PLANNING FOR RETIREMENT, PLAN TO DEAL THE MOST CRUSHING BLOW TO THE SYSTEM YOU POSSIBLY CAN. PURSUE A CAREER THAT WILL GIVE YOU SPECIAL ACCESS, INTEL, SKILLS AND/OR MATERIALS TO DEAL THAT BLOW. ONLY AFTER THE SYSTEM IS RAZED TO THE GROUND CAN WE BEGIN BUILDING A BRIGHT AND PROSPEROUS FUTURE - A FUTURE WORTH PLANNING FOR.

MAKE YOURSELF INDISPENSABLE TO THE SYSTEM. THEN, DISPENSE WITH THE SYSTEM.

Huh. I guess we WILL replace you.



Goldy
@GoldyHA



THIS MY PARTY BRUH WE NEVER GETTING HEALTHCARE

Name a mainstream political issue that pretty much all plebs agree on, and I'll tell you why it's never getting fixed.

This holds true regardless of whether the issue is healthcare, college tuition, immigration, whatever. You win elections by making promises, fulfilling them will only get your country dragged into a world war.

The System leaves problems unresolved so that the activist wing of the System has a cause to fight for to attract idealistic people and make sure they never apply themselves in any meaningful opposition to the System. It's all fake and gay, all the way down.

BLEED THE BEAST BUG-CHASING

Engaging in thievery and brigandry is the best possible strategy to secure what you need in this day and age.

As we aim to destroy the System, the more cuts we inflict upon it, the sooner it will die. Conversely, the more we feed into it (i.e., paying income tax, supporting big businesses), the longer it will live. If you deprive it of your support by not having a job or buying its goods (Total System Dropout) AND actively harm it by stealing and destroying, you are dealing double damage to the Beast that is destroying our race.

It has been scientifically proven that trying to chase down airborne insects like mosquitoes improves blood circulation and stamina while also strengthening the coordination between the eye and the rest of the body, greatly enhancing your professional and athletic performance to find out more, simply google "bugchasing".
– Architect Of Acceleration



LOW STAKES

2022 HARD RESET 2022

"THE HARD RESET" ----- ACCELERATIONIST MINDS
----- 😊 ----- COLLAPSITARIAN
----- NEVER LOSE HOPE ----- THE ENEMY IS TIRING
"HAHAHAHAHA" -- STRAIGHT THROUGH THE CROWD --



When movementarians try to talk to you about minimizing risks so you join their movement instead of cutting yourself a bowl, remind them that poking holes in transformers with a suppressed Ruger 10-22 is safer than joining an openly National Socialist political party.

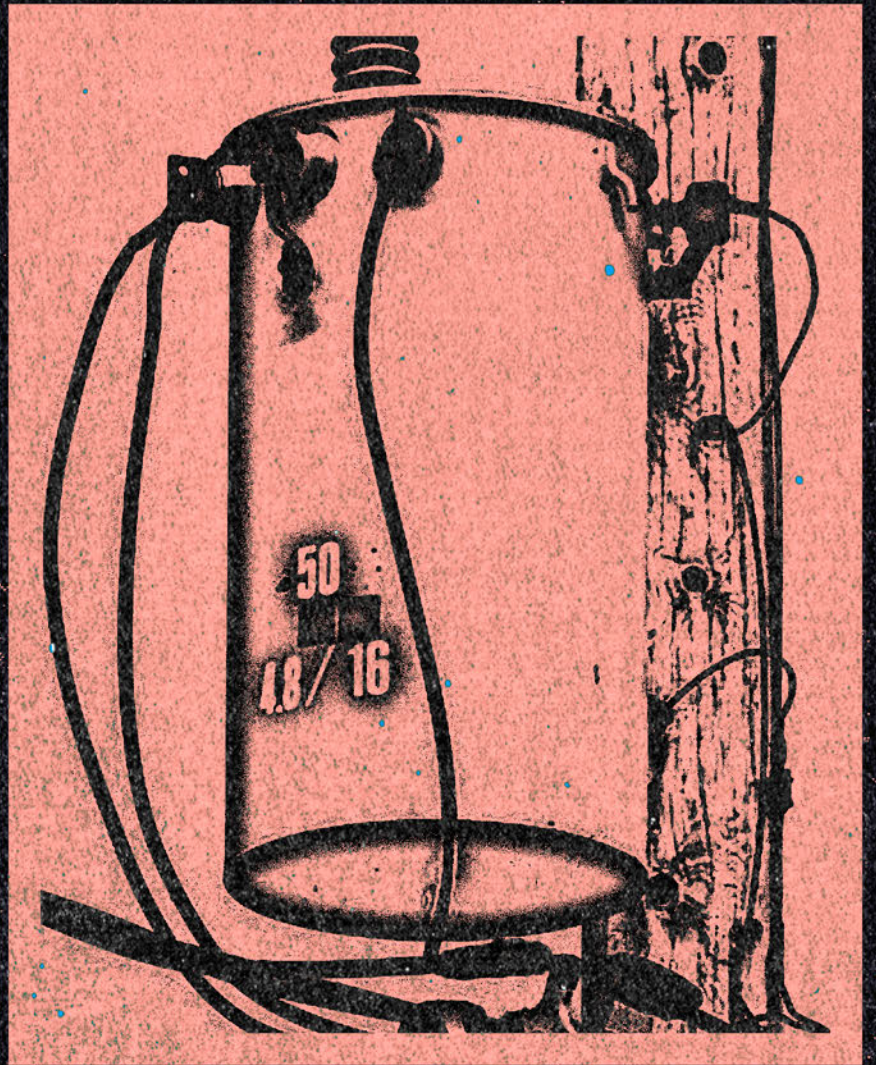

It seems a lot more fun...
because it is.

THE HARD RESET

Every time we eat any of the food sources listed below (and any time we eat the flesh and blood of another sentient being), we are participating in a satanic ritual. It's time to say 'no' by never purchasing products made with dead babies again. The same goes for listed "beauty" products and near all vaccines used in the last 60 years.

The following products are manufactured using aborted fetal cells:



PEPSI
CEO:RAMON LAGUARTA



KRAFT
CEO:ROBERT KRAFT



CADBURY
CEO:DIRK VAN DE PUT



NESTLÉ
CEO:MARK SCHNEIDER



NEOCUTIS/MERZ
CEO:PHILIP BURCHARD

- ALL PEPSI SOFT DRINKS
- SIERRA MIST SOFT DRINKS
- MOUNTAIN DEW SOFT DRINKS
- MUG ROOT BEER AND OTHER SOFT DRINKS
- NO FEAR BEVERAGES
- OCEAN SPRAY BEVERAGES
- SEATTLE'S BEST COFFEE
- TAZO BEVERAGES
- AMP ENERGY BEVERAGES
- AQUAFINA WATER - AQUAFINA FLAVORED BEVERAGES
- DOUBLESBOT ENERGY BEVERAGES
- FRAPPUCCINO BEVERAGES
- LIPTON TEA AND OTHER BEVERAGES
- PROPEL BEVERAGES
- SOBE BEVERAGES
- GATORADE BEVERAGES
- FIESTA MIRANDA BEVERAGES
- TROPICANA JUICES AND BEVERAGES

- BLACK JACK CHEWING GUM
- BUBBALOO BUBBLE GUM
- BUBBLICIOUS BUBBLE GUM
- CHICLETS
- CLORETS
- DENTYNE
- FRESHEN UP GUM
- SOUR CHERRY GUM (LIMITED)
- SOUR APPLE GUM (LIMITED)
- STRIDE
- TRIDENT

- SOUR CHERRY BLASTERS
- FRUIT MANIA
- BASSETT'S LIQUORICE ALL SORTS
- MAYNARDS WINE GUM
- SWEDISH FISH
- SWEDISH BERRIES
- JUICY SQUIRTS
- ORIGINAL GUMMIES
- FUZZY PEACH
- SOUR CHILLERS
- SOUR PATCH KIDS
- MINI FRUIT GUMS
- CERTS BREATH MINTS
- HALLS COUGH DROPS

- ALL COFFEE CREAMERS
- MAGGI BRAND INSTANT SOUPS, BOUILLON CUBES, KETCHUPS, SAUCES, SEASONING, INSTANT NOODLES

- BIO-GEL PREVEDEM JOURNEE
- BIO-SERUM LUMIERE
- BIO RESTORATIVE SKIN CREAM



CRUELTY-FREE
CANNIBALISM

This list is incomplete, the mere result of only an hour of research.

It's very likely that the vast majority of vaccines also contain the flesh and blood of unborn children.

Like tech CEOs, the CEOs of these garbage peddling companies need to be actively hunted.



**Don't worry so much about firing the first shot.
The System has fired enough of them.**

Papa

STRUGGLE ∞ PURPOSE FOREVER	FIFTH V SACRIFICE
COMRADES 8 PLAN ACTION	FOURTH IV DEVOTION INFLUENCE
FRIENDS ☼ CHILL LEARN	THIRD III INVOLVEMENT KNOWLEDGE
BURN ☢ TRAMPLE CRUSH	SECOND II INTRIGUE AWAKEN
A LIE ☘ HALL OF COST	FIRST I SIMPLE ASLEEP

wooden doors gas chamber slayer crew

LEGALIZE JOKES

The most effective way to tell the truth in this rotten world is to cloak it in humor and irony. This delivery disrupts the lemming's programming and sows the seeds of doubt in their mind.

You want an example? Sure. Put the funny guy on the spot, why don't you? Fine.

The other day I was having a conversation with a few specimens of Homo Normalfaggus and one of them mentioned how the police barely enforce laws against property crime. Seizing on the opportunity, I quipped "In all fairness, there's bigger fish to fry. Those officers should be going after real criminals, like holocaust deniers."

All I got in response was a nervous chuckle, but that isn't the point. The point is the delegitimization of the System in the minds of the sleepwalkers. What can they do, really? Scold you for making light of the worst atrocity since I stubbed my toe while on my way to take a shit at 3AM?

"No, man, I agree with you. I don't mind my wallet being stolen so long as the thief knows that 6 million jews died 80 years ago." They're going to look ridiculous, because that's what they are. If they press you further, pretend that you're a prisoner being carried away and start mocking them further.



the color

134

of gas!

THE HARD

RESET

SHUT THEM IN OSCAR



You could be the wignat welding the vault door shut on the private underground city doomsday complexes that would somday keep the likes of jeff bezos and bill gates safe.

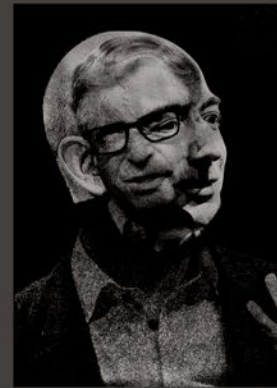

DISCOUNT SMELLS INDIA

1 *If you smell like some garbage like "old spice hawaiian breeze", or "axe dark temptation" you're a gay retard and don't deserve anything more than the endocrine disruptors filling your body.*

Same goes for deodorant, stop using that shit. Why you ever ask yourself why you need aluminum and HRT-adjacent chemicals on one of the most absorbent parts of your body anyway?

Do you wear "under-armour", or any other dyed nylon products? You're making yourself gay. Not only are you wearing yoga pants for men, you're also putting synthetic soy-based dyes all over your dick and balls. "Oh yeah I don't eat soy" as you absorb it through your reproductive organs.

2 *Anyone eating cereal? Tons of carbs in the morning to stamp out all the free-test your body was creating while you were in REM. Dr. Kellogg, the creator of the breakfast cereal wasn't jewish, but he hated sex, and his solution was to propagandize people in to consuming tons of carbs right when they woke up, which murders your test for the day. Corn flakes are an anaphrodisiac.*

Back on topic, if you smell like anything but a man smells like, you're probably on a pretty good path to no longer desire to be a man...

THE HARD RESET

VISITING THE CITY - Tango
PAGE-136

THE HARD RESET

VISITING THE CITY - Tango

PAGE - 137

The city is the epicenter the of anti-nature movement. Urbanites pride themselves on living as unnatural as possible and their environment reflects this very clearly. Therefore, it is morally justified to treat it like the dumpster that it is. So next time you're visiting the city, don't be afraid to throw your trash on the streets or better yet throw it in their coveted parks. Think of it as putting the tax dollars to work. And while you're at it you could contribute to the municipal statistic of public defecation. I'm sure the mighty concrete jungle will work its magic and use it as composting for its endless greenery someday. Plus, you could pick up some spray paint and do some renovations to nearby building walls, I hear city folk love "urban murals". And why not encourage your neighbor to use city transport by dropping some nails on the road, just one step towards shrinking our environmental footprint! As we know, homelessness is a problem affecting some many in our urban community, their struggle for warmth is a fact that tugs at my heart strings. To lend them a hand, why don't you pick a spot in the city (anywhere really, they will be more than thankful) and start a fire, make sure it's big and gets really hot to ensure our lovely homeless individuals don't get cold in the frigid temperatures. Finally, when your fantastic getaway has finally come to an end, you should give a city dweller the authentic Black American experience because there's a chance they haven't become fully integrated with the diverse culture. In order to spread their beautiful tradition, find a white individual that really looks like they belong in the city (they will appreciate it the most), put a mask on and wait behind a corner, and when they pass by surprise them by just wailing on them, bonus points if you have an accessory like a bat. Keep punching, hitting and kicking despite their pleas for mercy. And when you've reached your cultural enrichment limit just run away, they'll get the message loud and clear. Thus concludes your trip to the big city. I can't wait until next time!

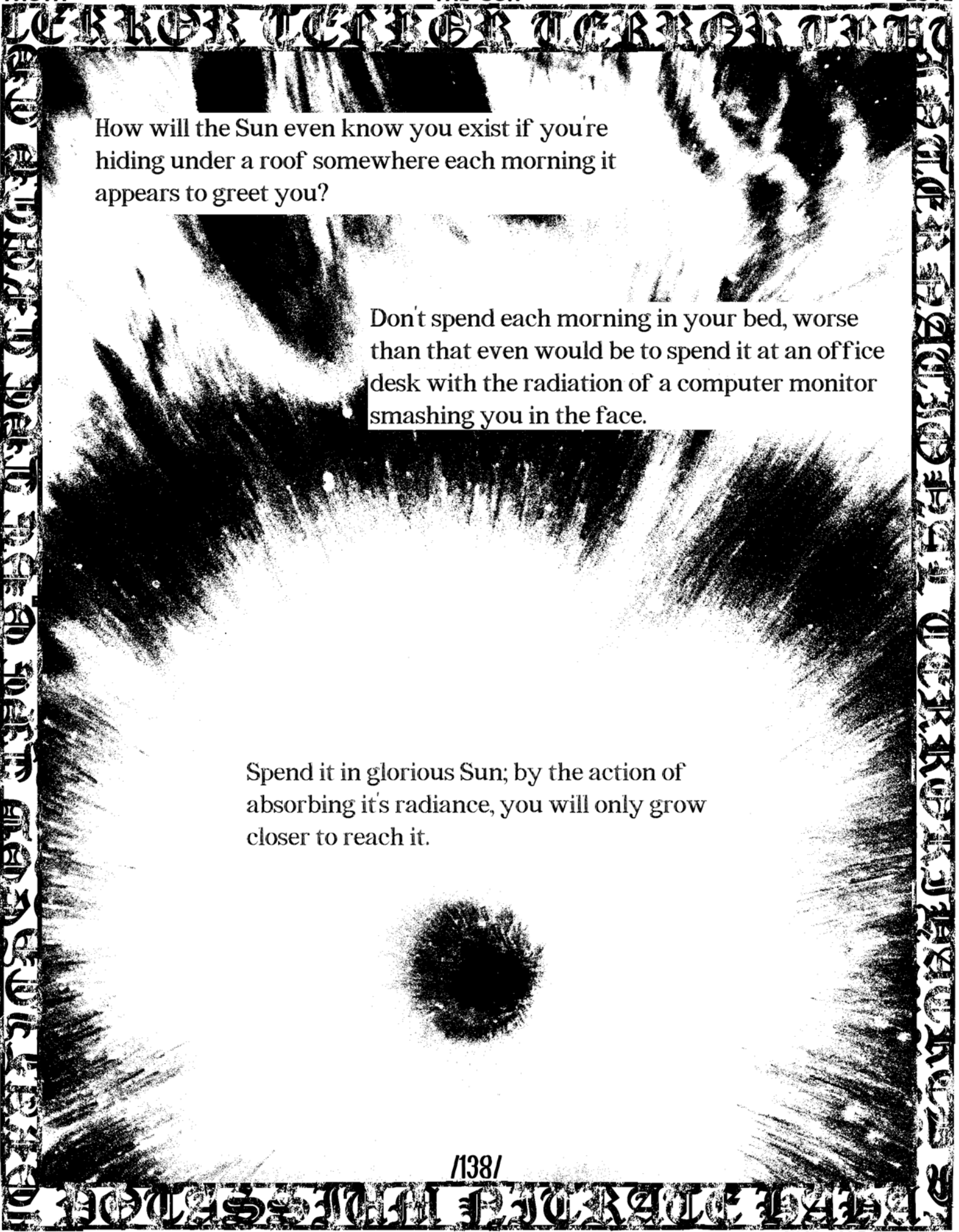

How will the Sun even know you exist if you're hiding under a roof somewhere each morning it appears to greet you?

Don't spend each morning in your bed, worse than that even would be to spend it at an office desk with the radiation of a computer monitor smashing you in the face.

Spend it in glorious Sun; by the action of absorbing it's radiance, you will only grow closer to reach it.

/138/

NATURAL ORDER



Oscar

P-139

Hard Reset



If your people don't follow the Natural Order, you will be replaced by those who do.

If you call yourself a dog mom or a cat dad, you will be replaced by men with five kids each.

If you think guns are icky, you will be replaced by men who own illegal full auto assault rifles.

If you believe in feminism, you will be replaced by men who keep their women in check.

If you believe in mass democracy, you will be replaced by people who don't second-guess their leaders.

If you want every person in the world to have their needs taken care of by the government, you will be replaced by those who make everybody contribute to the common cause.

If you think trans rights are human rights, you will be replaced by people who respect neither.





WATER, THE GREAT GRANDFATHER OF ALL

**The Superior flows in to the
Huron**

**Breaks are made, flow finds or
arrives to and from Michigan, or
the Georgian**

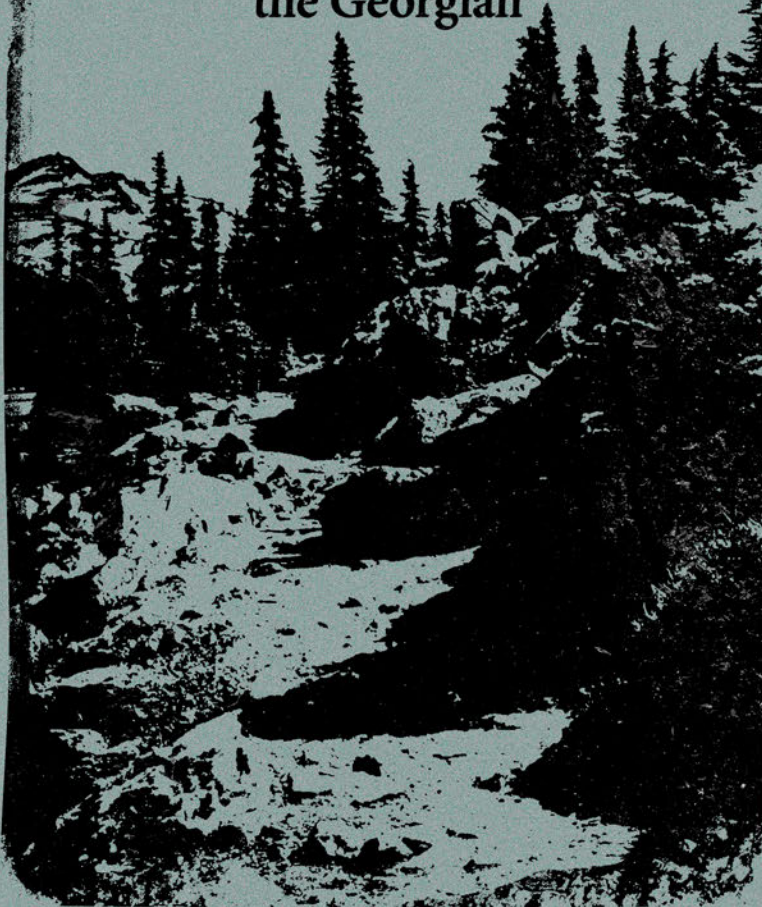

**Flow continues through Erie
To Ontario**

Then on to St. Lawrence

Finally, the North Atlantic

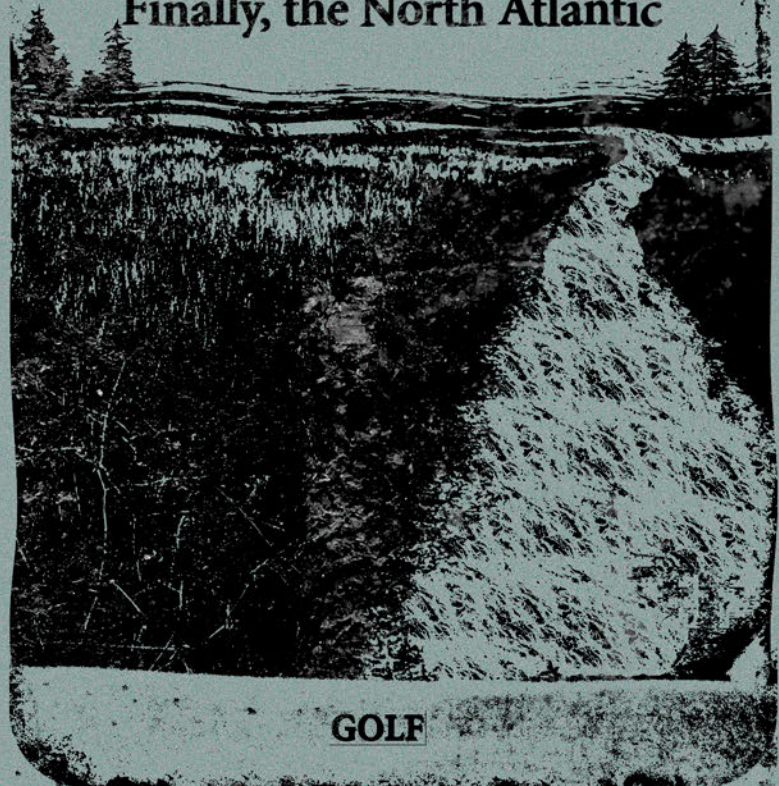

**Fresh water, great lakes, reserves of health and the growth of life-force.
Grandfather Superior, the Great Grandfather of the Ocean.**

**But all along the way, commercial discharge, heavy metal, garbage, glass, feces, industrial chemicals.
The people polluting the life-source here are no different than the chinese dumping large amounts of
Dichlorvos in to their ponds to murder all fish and shrimp, leaving only sea-cucumbers for collection.**

**The semitic view on nature, that we aren't within it, but that we are above it; not a view held by just
semitic populations any longer, but also the subjects of an evil semitic world.**

The Great Lakes, regenerative, our polluting enemies, degenerative.

FUMIGATE THE CITIES



THE HARD RESET

WHISKEY



BIRTY BOMBS ARE THE HOLY GRAIL OF TERRORISM.

No one's pulled it off yet, but a French madlad came very close in 2021. In case you missed or memory holed the story, a 26 year old White extremist manufactured 4 "mini nukes" using uranium oxide powder he bought on eBay. Nothing went wrong during the manufacturing process. He didn't make himself sick with radiation poisoning. The bombs were ready to detonate. What went wrong?

He couldn't keep his mouth shut. Boasting of his bomb making prowess at school led concerned classmates to report him to police, who discovered the devices when they raided his home.

If you're curious, YES - uranium ore can still be purchased online. And YES - with basic precautions and proper PPE, you could easily incorporate a radiological payload into a conventional bomb or incendiary device. Radiation poisoning won't kill most of your targets, but you could easily injure thousands. And if detonated in an overcrowded, bustling urban center - think NY, LA or DC - you could grind the System's gears to a screeching halt.





1. Obtain uranium ore



2. Crush with hammer



3. Weigh out 300g

You could wreak havoc and cause destruction far beyond your blast radius. Such an attack would terrorize urbanites and cripple the System like nothing else. Imagine an entire metropolis forced to evacuate without a moment's notice. Imagine a vital epicenter of commerce and industry depopulated, out of commission for weeks or months until radioactive decontamination and cleanup is completed. Imagine the lost revenue, lost productivity, and astronomical financial burden the System would be forced to bear. Imagine the paralyzing fear instilled in the public, too afraid to return home even after the System assures them it's safe.

Neither rampant degeneracy nor mud-on-White crime can occur in an empty city. Imagine a city free of pests and parasites. No feral niggers. No drug addicted transients. No free-range whores, trannies or faggots. No kike slumlords. No tent cities full of illegals and rapefugees. No working class Whites subjected to the aforementioned horrors as they step over piles of subhuman shit and dirty needles on their way to work every morning.

You can put a stop to it - ALL of it - for a very long time, if you wanted to.

FUMIGATE THE CITIES. CRIPPLE THE SYSTEM. MAKE HISTORY.



4. Process crushed uranium using a ball mill



5. Mill for 2hrs approximately



6. Remove steel balls from the milled powder

W
W
E
E
E
D
D
D
S
S
P
P
U
R
R
P
P
O
S
S
E
E
I
I
S
S
T
T
O
O
L
L
I
I
M
M
I
I
T
T
Y
Y
O
O
U
U

CONSIDER THE FOLLOWING:
THE LESS THINGS
YOU HAVE IN COMMON WITH

JAMAICANS

THE BETTER.
(NIGGER)
THAT MEANS NO
MORE NEGROID
POISON IN
YOUR LIFE.
STRAIGHT
EDGE
NOW



IF I

MADE 
ANY 
CLAIM 

TO BE A NATIONAL SOCIALIST,
I WOULDN'T BE DEFENDING
SMOKING WEED, NOR WOULD I
BE PROUD I EVER DID IT.

X X X

IF ANYTHING, I'D BE TAKING THE
STEPS TO LIMIT AND ELIMINATE
THE HABIT ENTIRELY. NEVER
DEFENDING IT, NEVER
ATTEMPTING TO JUSTIFY IT.

1

ANY DISSIDENT, AT LEAST WHEN
ANY EXTREMIST SOMEONE USES
OR STIMULANTS OR PSYCHEDELICS,
REVOLUTIONARY, STEROIDS, YOU ALCOHOL, THE
WHETHER HE'S CAN SEE AN STRIDES THEY
WITH US OR OBJECTIVE MAKE ARE
NOT, SHOULD INCREASE IN THEIR CLAIMED AND
NOT BE PERFORMANCE, THEMSELVES.
SMOKING WEED, AESTHETICS, AND THEIR
OR DRINKING ON THEIR ABILITY ARE ANECDOTAL
ALCOHOL FOR TO CHANGE THE R E A L
THAT MATTER. W O R L D . MEASUREMENTS
OF IMPROVEMENT.

2

3

WHEN SOMEONE SMOKES WEED,
T A K E S
OR PSYCHEDELICS,
OR DRINKS
ALCOHOL, THE
ONLY GAINS AND
STRIDES THEY
MAKE ARE
ALLEGED AND
CLAIMED BY
THEMSELVES.
THEIR
IMPROVEMENTS
ARE ANECDOTAL
THERE ARE NO
R E A L
MEASUREMENTS
OF IMPROVEMENT.

X X X
X X X

A
R
H
N
D
R
E
S
E
T



THE HARD RESET
NOT FOR WIGGERS

NOT FOR NIGGER
WANNA-BES

NOT FOR THE
SEDATED

NOT FOR THOSE
LOOKING TO
DULL REALITY

"PUBLIC BOOT, PRIVATE BOOT"

TAX THE RICH, YOU SAY? I COULDN'T CARE LESS WHETHER THE NEXT PRIDE PARADE GETS FUNDED OUT OF SOME BILLIONAIRE JEW'S POCKET OR BY ZOG ITSELF. THE SYSTEM IS THE SYSTEM - IT FUNDS ITSELF. FAT CATS NOT CONTRIBUTING TO SOCIETY MAKE PEOPLE UPSET. GOOD - RADICAL CHANGE IS MORE EASILY BROUGHT ABOUT THAT WAY.

IT WON'T COME FROM THE HALLOWED HALLS OF DEMOCRACY.



THE HUMANITARIAN OSCAR

"A CHALLENGER APPEARS"

REALITY FLIES IN THE FACE OF LEFTIST THEORY LIKE A DODGE CHALLENGER.



THE HILARIOUS OSCAR

HARD



NATURAL ORDER
ARRANGES US
ALL IN
THE UNIVERSE
- TERRORMAN

HARD

"YOU WILL NEVER BE A WOMAN"

WAS IT WORTH IT? A TRANNY USUALLY DIES BY BEFORE 25. NEARLY ALWAYS SURVIVED BY HIS PARENTS.



THE HONEST OSCAR

PAGE



A HEALTHY
LIFESTYLE
ALLOWS YOU TO
STAND ON THE SUN
- TERRORMAN

PAGE



THE HARD RESET
MESSAGE FOR THE BROKEN

YOU AND ME

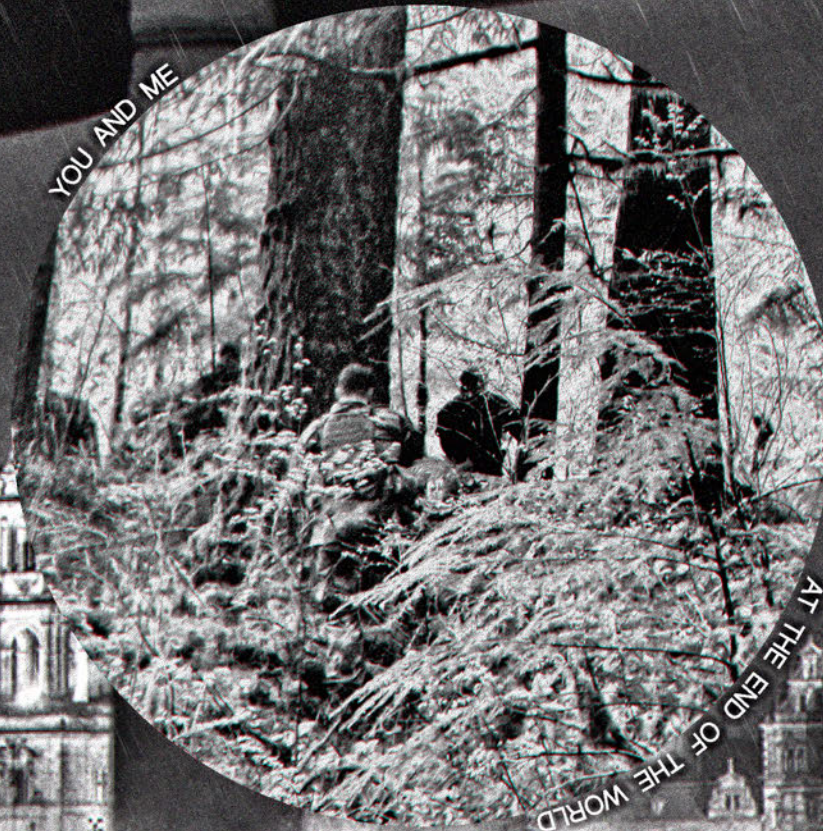

AT THE END OF THE WORLD

Look at you. Yeah, I see you, no point in hiding, can't hide from me, I'm part of you. Maybe I'm the inner voice you just stopped listening to at some point. Perhaps I'm the echo of something somebody told you, somebody you respected. You know, back when "respect" meant something to you.

You've really seen better days, haven't you?

I could tell you about how your life is a mess, but you already know all that. You also know that you do nothing to improve your condition despite knowing that you're losing. Imagine the glee the System feels when it beholds husks like you. Your life robbed of all meaning; you're expected to sign the paperwork for your unconditional surrender with the blood from your wrists.

But you've got potential. You've lost all fear of death. You've been pushed to the limit and then some, and you're still standing. I don't want you dangling from a noose, I want you in my squad when we go [REDACTED] the next AIPAC conference.

Your life is the logical conclusion of your ancestors struggling for tens of thousands of years. However long your tenure may be, it's your duty to make it count and go out with a bang.

**MAGA
WAFFEN
MK
ULTRA
ACTIV
ATION
TUTOR
IAL**

A red line-art illustration of a classical building with a flag on top, serving as a background for the text.

H



R

WHEN IN DOUBT, PUT ANOTHER FOOT ON THE GAS PEDAL. ALWAYS ERR ON THE SIDE OF ACCELERATION. WHEN PRESENTED WITH OFFICIAL EVIDENCE OF THE 2020 ELECTION HAVING BEEN FAIR AND SQUARE, WHAT WILL YOU SAY TO CONSERVATARD NORMIES IN YOUR CIRCLES? YOU WILL SAY THAT THIS IS JUST MORE PROOF OF THE SYSTEM DESPERATELY TRYING TO COVER ITS TRACKS AND PUT A LID ON THE WHOLE THING.

WHEN, ON THE CONTRARY, YOU GET BREAKING NEWS THAT SOMETHING REALLY DID HAPPEN OUT OF THE ORDINARY, WHAT WILL YOU DO? YOU WILL AGAIN ERR ON THE SIDE OF ACCELERATION AND TELL THE NORMIE THAT NO AMOUNT OF ELECTIONS OR POLITICAL CANDIDATES WILL GET US OUT OF THIS MESS, BECAUSE THE SYSTEM WILL JUST RIG ALL OF THOSE TOO, AND BRIBE ALL THE CANDIDATES AS WELL, WHILE IT'S AT IT.

NO POINT TRYING OUT NARRATIVES THAT APOLOGIZE FOR THE SYSTEM'S ACTIONS OR THAT SOMEHOW TRY TO LEND IT LEGITIMACY. FOUR FEET ON THE GAS PEDAL FOR THIS ROTTEN WORLD UNTIL WE REACH THE EXIT.

03:01, backpack ready, time correct, sneakers cleaned and laced.

Chambering a round—it should not be necessary today, but getting things done alone makes me jumpy.

It has been long time since I was involved in guerilla. Nevertheless, I don't really have hesitations—plan is superb, location heavily scouted, hell, I spent so much time scouting, that had a spare moment to fuck up Azer dude one evening.

That made scouting a bit less boring, but still: when doing everything yourself—reconnaissance is most dull and taxing part of work.

Night city is calm and subdued, huge concrete blocks are devoid of light, it might seem that they are lifeless as well, but that's illusion: dwellers are just sleeping, getting ready to wake up at 07:00, drink shitty coffee, put on bleak clothes and fuck off to whichever wageslavery they found themselves in. Most probably by that time I will already be sleeping in bed—never was and never will be morning person.

The walk to my destination is a long one, plenty of time to think. I would prefer listening some good music, but bringing phone would be foolish, and my MP3 player was broken in a brawl more than 2 years ago. Life changes rapidly, not so long ago it was cool to have CD-player, cameras were rare, almost non-existent. Blessed times, when nobody really cared about "muh security" and beaten Untermensch never made into national news.

This change in street security is often used as an excuse to inaction, but truly it's only an obstacle, one more challenge to overcome.

After all, if you can't bypass couple of cameras in city with millions of occupants—direct action is just not meant for you.

Thinking about surveillance I take a turn right to dimly lit yard of typical 9-floor building. Yard is so-called jump-airfield on the other side of the building are parked couple of cars and a trailer of local "businessmen"—pack of sandniggers from Dagestan. Funny part of it is that they are paying the price of being rude to wrong people, most probably I would never spend this amount of effort if they didn't piss me off a month ago.

As Tesak said: life is series of accidents. Today is the day, a pleasant one for me.

Putting on gloves, getting a 7-liter bottle with oil-gas cocktail from the backpack, checking handgun and setting up stopwatch. Persistent misconception from movies is that everything should be done in an extreme hurry. Instead, I leisurely stroll to first car—Mazda6, looks new, or maybe just well kept.

Other two cars look kinda old—after all as far as I know these are "work cars". Funny, how much money can shitty street food make you, right?

After applying compound to all 3 cars, I am making a decision to break window in the Mazda, for good measure—maybe I secretly hope that someone will come out to shoot him, who knows. Alarm goes off, I throw 3 "fireballs" (folded paper soaked in gas with small pebble inside, never light large amounts of petrol by hand not to get torched) to ignite all cars and run off. I barely make 200 meters from there when something explodes and alarms of dozen other cars go off. Must be something in that kitchen-trailer.

Stopwatch shows little less than 4 minutes as I switch it off on the run—I thought timing was closer to 2 min. Looks like adrenaline twisted my sense of time—that's why a watch is mandatory all times. After passing 3 blocks I slow down to a stroll again. After 10 more minutes of walking fireman can be heard in the distance—they took their time.

Night city is still fast asleep, but heart warms up, when I think about chaos that unfolds couple of streets behind me—I can bet whole "kishlak" of sandniggers are trying to put out fire now, yelling obscenities in their abhorrent language.

Maybe they will pack their shit and leave, most probably they won't, but what is certain—next couple of weeks they won't have much time harassing bypassing girls from their trailer.

My house is warm and cozy, curtains are slightly ajar and first rays of light sneak inside, my neighbor is probably grumbling as he begins his morning routine. I discharge the gun and throw it on the armchair—as expected it was not needed tonight.

Sleep overcomes me, bringing back sounds of alarm and panicked screams. Looks like I'm going wake up late. Good to be me.

THE HARD RESET

Jack Letts – Golf



"If there was a battle, I'm ready"

PAGE -150

HARD TRAINING - Hotel



Hard training against racial embarrassment

Next time you want to get a fashy tee, a swastika tattoo, some racist jewelry, or anything that has you walking around saying "I'm racist", consider the embarrassment you might be if you're not the strongest and smartest guy around. Imagine you have your new Militant Zone t-shirt on, you go to class at your local martial arts gym, and a shit stinking indian man who has been training grappling for 10 years calls you out. You better make sure you're able to beat him before you put that shirt on in the morning. People have cellphones, and they love to film. Faggots have reddit accounts, they love reddit internet good guy points, and they would love to post a video titled "Nazi gets beat up by brown man". The same goes for lifting weights as well.

Unless you're hitting big numbers and clearly not on gear, then there's no reason to parade our symbols around a bunch of whores and niggers using the same gym as an instagram studio. All it takes is a few ego lifts bigger than yours to eliminate any energy you were holding in there.

Don't be a racial embarrassment when the time comes.

HOTEL

HARD

RESET

ACCELERATED TRAINING

Oh there will be hard conditions?
All the better.

You should always run in bad conditions like a hard, practically sideways rain if you can. It will always be superior over one done under a calming blue sky; you'll apply yourself more and benefit from the magnified difficulties present.

Will this idea be present across all forms of training? Yes. The same can be said for any form of training. If you're sparring pad work, have your partner hit a little harder than they're comfortable with, and promise them you'll do the same.

Experience is heightened in these conditions. You don't go to the gym to lift just half of what you can max, so why make any other form of training easier?

Great and difficult factors won't only benefit skill gain, but also comradery. There's a seldom spoke about benefit to mutual suffering - that it quickly builds unconditional trust between yourself and those suffering with you. The military knows this, the police academies know this, and you know it now too.

Suffering hard, and suffering in good company, is an easy power move.

+ 01. PRESENCE

+ 02. EXERTION

+ 03. SACRIFICE

+ 04. BLOOD

+ 05. SWEAT

+ 06. EXPERIENCE

+ 07. LEARN

+ 08. UNDERSTAND

+ 09. IMPROVE

+ 10. TEACH

XX. KILL

PAGE 152
PAGE 152
PAGE 152
PAGE 152
PAGE 152
PAGE 152
PAGE 152

...wretched technology will be
...to drop his corro... plans, the
...risk and weight of the... nation in
...the world will prevent... from
...all... on the mo...

...our... enemies'...
...necks.
...another... great
...on them pe...

for the worldview to come in... ition
our enemies must... acts
lacking of any... against
...em. they would pull...

...us, drop
...the weight of
the... world. the
...online.
...their... mem...
...their souls.

HARD **R**



C O N S I D E R D E T A I L S L I K E . . .

I

WEAPONS PREPARATION: ACQUISITION OF THE TOOLS TO BE USED. BOUGHT WITH CASH, WEARING A MASK, AND A LONG TIME AGO, FAR FAR AWAY.

II

MENTAL PREPARATION: READY TO STRIKE, READY TO RUN, READY TO CHEAT, READY TO SUFFER, READY TO KILL IF NEEDED.

III

PHYSICAL PREPARATION: TRAINING AND CONDITIONING OF THE LIMBS, LUNGS, AND HEART. ENDURANCE AND STRENGTH IN A HEALTHY BODY.

IV

ACQUISITION OF TRANSPORTATION EQUIPMENT: ATV, DIRTBIKE, MOUNTAIN BIKE, TRUCK, OR ANY TYPE OF VEHICLE ALLOWING TRANSPORT OFF-ROAD.

V

ACQUISITION OF TACTICAL EQUIPMENT FOR EXTENDED RECON, OBSERVATION (DRONES), COMMUNICATIONS (RADIOS), NAVIGATION, AND STEALTH.

VI

UTILIZING SOCIAL MEDIA, MAPS SERVICES, AND STREET VIEW IN ORDER TO DETERMINE LIKELY NUMBERS OF PEOPLE, VEHICLES, AND SECURITY PRESENT.

VII

PRACTICING DRY RUNS NEARBY WITH DAY, NIGHT, WEATHER CONDITIONS, AND HOLIDAYS ALL CONSIDERED. NOTING ALL INFORMATION POSSIBLE.

VIII

RESEARCH TO DETERMINE PROPER STRIKE TARGETS, COMMON WEAK-POINTS, RESPONSE TIMES, AND SCHEDULES RELATED TO THE TARGET.

IX

POST-OPERATION ESCAPE, AND EVASION. WHAT DO TO IN THE FOLLOWING MONTHS OF THE ATTACK TO STAY AS SAFE AS POSSIBLE.

X

WHILE TECHNOLOGY IS ONE OF OUR BIGGEST ENEMIES IN THE MODERN WORLD, IT CAN ALSO BE USED EXTENSIVELY AGAINST ITSELF. FROM I - IX, THE MILITANT CAN UTILIZE A FULL STRIKE PLAN AGAINST HIS OR HER TARGET WITH LITTLE TO NO RISK PRESENT UNTIL THE EVENTUAL DAY OF TRUE ACTION COMES.



T A R G E T

XI

THE LEGAL PATH
DRIVEN IN ON.
IDEALLY WITH AN
OFF-ROAD VEHICLE
CONCEALED.

XII

A DISTANCED AND
WELL HIDDEN
PARKING SPACE
FOR PARKING AND
DEPLOYING FROM.

XIII

A LESS-TRAVELLED
OFF-ROAD PATH
FOR NAVIGATING
TO THE LOCATION.
RUGGED IS BETTER.

XIV

AN IDEAL
OBSERVATION
POINT FOR
CHECKING AND
CONFIRMING ALL.

XV

THE TARGET ITSELF.
FALSEHOOD STILL
STANDING,
WAITING FOR YOU
TO TEAR IT DOWN.



IMMORTALITY

Adolf Hitler never really died. I'm not talking about the theories about his escape to Argentina or whatever, I'm talking about the fact that for all intents and purposes, his legacy has been strong enough to make it so even 75 years after his supposed "death", it's as if he was still among us.

The System uses him as the ultimate scarecrow, the ultimate example – "don't be a bad goy or you'll end up like him", the ultimate justification for their pacification efforts aimed at the White race.

The liberal establishment toadies use him as the biggest evil in human form, their soft brains failing to grasp just how a man could do so much in so little time and gain the support of so many of his countrymen in the process. No modern politician comes close, regardless of how much propaganda they use.

There's us, of course, upholding his legacy. We do our part as well, attracting idealistic young men of our race to the hope of a different, better world.

How could such a hope be represented by a man who's been dead for longer than most people on Earth have been alive? Turns out, Adolf Hitler represents us and we represent him. When the libtards fear the "Nazis", they have the image of Hitler persecuting the poor powerless political opponents of the German nation. Well, about that... I have good news and bad news for our little friends.

The good news is, Adolf Hitler won't rise from the dead and put you in a labor camp. The bad news is, we're going to be the instruments of his vision, faithfully carrying it out until our deaths, and we have neither camps nor patience for race traitors.

You only get one chance at penance, if that. Choose wisely.

HOLY LEAGUE OF CATHOLIC LIFTER-SHITPOSTERS

OSCAR - WITH A NOFAP VETERAN

I'VE BEEN ASKED HOW MY FEDPOSTING ENERGY IS ALWAYS ON 1488%, WELL HERE IS MY DAILY ROUTINE SO THAT EVERY ONE OF MY WIGNATS COULD BE A PAIN IN THE ASS FOR EVERY GLOWNIGGER ON THE PLANET

1. WAKE THE FUCK UP READY TO ANNIHILATE ISRAEL

2. DEAD COLD SHOWER

3. BREAKFAST WITH RAW MEAT AND KHAZAR MILK

4. GO TO GYM, EIGHT HOUR ARM WORKOUT TO BUILD UPPER BODY STRENGTH FOR THROWING BEANERS BACK ACROSS THE BORDER

5. COME FROM GYM, DRINK CHOCCY MILK

6. PRAY A ROSARY

7. PROMOTE DOMESTIC TERRORISM ON TELEGRAM

8. DENYING THE HOLOCOUST FOR 2 HOURS STRAIGHT

9. STUDYING CUZ I AM NOT A NIGGER THEN GOING TO BED HAPPILY

THE HARD RESET

PAGE 157

WHITE TERROR NIRVANA

Think spiritual enlightenment is unattainable in a world plagued by Godless hedonism? Think again.

HE WHO WALKS IN THE NOBLE EIGHTFOLD PATH WITH UNSWERVING DETERMINATION IS SURE TO REACH WHITE TERROR NIRVANA.



Nirvana, an end to all earthly suffering, is just a few dead targets away.



3 DEAD PIGS, 5 YEARS ON DEATH ROW

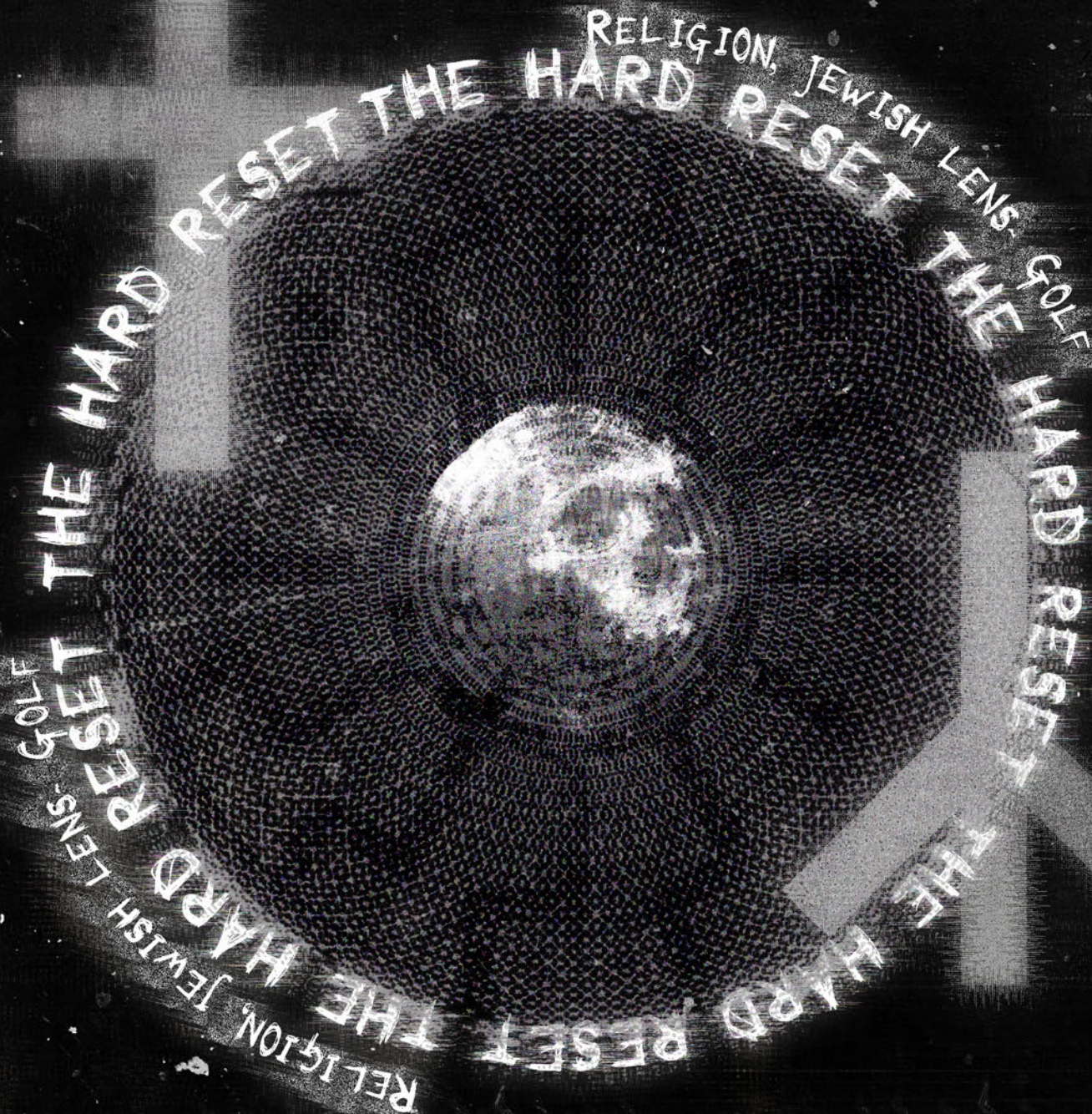

WE WILL GET NOWHERE AS A RACE, SHOULD WE CONTINUE TO VIEW ONE ANOTHER'S RELIGIOUS VIEWS THROUGH A JEWISH LENS. PAGANISM AS SEEN BY A JEWISH LENS - "WOTAN AS A FAGGOT, LARD LARD LARD, ART HOE CRINGE RELIGION". CHRISTIANITY AS SEEN BY A JEWISH LENS - "UNITED CHURCHES DEFINE CHRISTIANITY, LARD LARD LARD, DESERT RELIGION PRACTICED BY NIGGERS IN AFRICA". FOR WE HAVE DISCOVERED HITLER, WE HAVE NO MORE REASON TO PURSUE THE LIKES OF JESUS CHRIST OR WOTAN INDIVIDUALLY, AND TO ATTACK THE OTHER. THE JEWISH WORLD GOVERNMENTS OF TODAY WOULD RATHER HAVE IT THAT WE CHASE AFTER ONE OR ANOTHER AND ARGUE IN THEIR FAVOR, BUT WHY WASTE THE TIME WHEN SHOULD BE EMBRACING THE WORLDVIEW OF FASCISM TOGETHER

THE HARD RESET

WILL TO POWER HOTEL

WE DON'T HAVE MANY THINGS IN THIS WAR ABOVE OUR ENEMIES,
BUT WE HAVE FANATICISM. THE CAPITALIST DOESN'T DIE FOR HIS MONEY,
AND THE COMMUNIST DOESN'T DIE FOR THE DISTRIBUTION OF THE STATE'S MONEY.
NEITHER OF THEM DIE FOR THEIR TWISTED SEXUAL VIEWS AND DESIRES ON SOCIETY,
TYPICALLY PEDOPHILIC.

IF YOU ALLOW OTHERS WITH LESSER WORLDVIEWS TO EXPRESS THEM
IN WAYS MORE FANATICAL THAN OUR OWN,
THEN YOU HAVE NOTHING.

THE SYSTEM POWER STRUGGLE BETWEEN LIBERALS AND CONSERVATIVES IS A PRIME EXAMPLE OF THIS.
WHILE CONSERVATIVES ARGUE FOR EQUAL TREATMENT, LIBERALS ARGUE FOR CONSERVATIVES TO BE EXECUTED.
WHILE CONSERVATIVES ARGUE FOR FAIR PARENTAL RIGHTS, LIBERALS IMPOSE HOMO STATE RIGHTS OVER CHILDREN.
WHILE CONSERVATIVES WOULD NEVER WEAR A MASK OR DO A CRIME,
LIBERALS SMASH UP ENTIRE DOWNTOWN AREAS BECAUSE OVER AN ABORTION LAW OR DEAD NIGGER.
WHILE CONSERVATIVES ARE POUTING OUT ABOUT HOW "VAXXED OR NOT, WE CAN STILL BE FRIENDS!"
LIBERALS ARE EXCLUDING UN-VACCINATED FAMILY MEMBERS FROM CHRISTMAS DINNER
AND KICKING UP OLD FAMILY DIRT ON THEM.

LIBERALS ARE MORE FANATICAL THAN CONSERVATIVES, AND BECAUSE OF THIS,
CONSERVATISM HAS BEEN A LOSING BATTLE FOR A CENTURY.

DON'T LET SOME MIDDLE MANAGEMENT CAT MOM HOOKED ON JEWISH PILLS PUT YOU IN CHAINS,
DON'T LET HER BE MORE FANATICAL THAN YOU CLAIM TO BE.

THE HARD RESET

EXTERMINATOR - ZULU

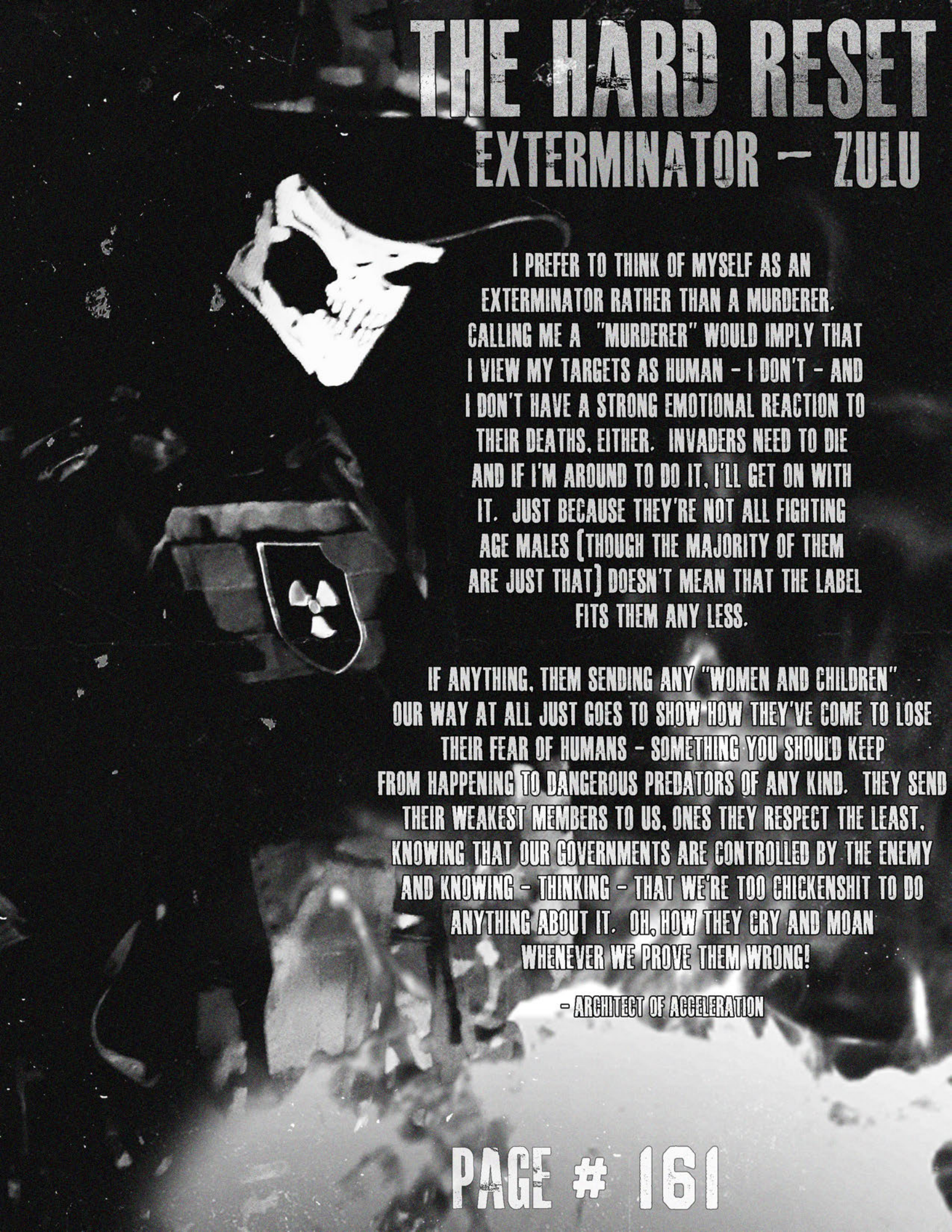

I PREFER TO THINK OF MYSELF AS AN EXTERMINATOR RATHER THAN A MURDERER. CALLING ME A "MURDERER" WOULD IMPLY THAT I VIEW MY TARGETS AS HUMAN - I DON'T - AND I DON'T HAVE A STRONG EMOTIONAL REACTION TO THEIR DEATHS, EITHER. INVADERS NEED TO DIE AND IF I'M AROUND TO DO IT, I'LL GET ON WITH IT. JUST BECAUSE THEY'RE NOT ALL FIGHTING AGE MALES (THOUGH THE MAJORITY OF THEM ARE JUST THAT) DOESN'T MEAN THAT THE LABEL FITS THEM ANY LESS.

IF ANYTHING, THEM SENDING ANY "WOMEN AND CHILDREN" OUR WAY AT ALL JUST GOES TO SHOW HOW THEY'VE COME TO LOSE THEIR FEAR OF HUMANS - SOMETHING YOU SHOULD KEEP FROM HAPPENING TO DANGEROUS PREDATORS OF ANY KIND. THEY SEND THEIR WEAKEST MEMBERS TO US, ONES THEY RESPECT THE LEAST, KNOWING THAT OUR GOVERNMENTS ARE CONTROLLED BY THE ENEMY AND KNOWING - THINKING - THAT WE'RE TOO CHICKENSHIT TO DO ANYTHING ABOUT IT. OH, HOW THEY CRY AND MOAN WHENEVER WE PROVE THEM WRONG!

- ARCHITECT OF ACCELERATION

THE AWD MORAL CODE

The moral code of the AWD is simple: you have a moral (among other things such as racial responsibility, metaphysical duty etc. etc.) duty to engage in and win this revolution against the Zionist Occupational Government and all of its various enablers. From the core and the creators (International Jewry) to the lowest peons (Black Lives Matter, Antifa and the likes). This moral code has an external and internal principle. This can be best summed up in this one quote from SIEGE, by James Mason:

"For our part, we will welcome and honor as COMRADES any White, bar none, who wishes to join with us in the struggle. ANY action taken against the Enemy, no holds barred, is a heroic deed. For our part, we will tolerate no divisive moralism to hamstring our efforts."

- James Mason, SIEGE

PRINCIPLE

INTERNAL

As a revolutionary you have a moral obligation to contribute as much as you possibly can to this struggle. This means you have a duty to constantly self-improve and strive to reach your upper limit and be the best National Socialist Revolutionary you can possibly be. You have a duty to make your body and mind a weapon. You have a duty to own and become proficient with the use of weapons. You have a duty to have resources stockpiled in case of the breakdown of supply chains that will naturally go hand in hand with societal collapse. You have a duty to have immediate plans in place in the case of a societal collapse. You have a duty to network with comrades so that when society does collapse, either by our actions or the simple ineptitude and inability of the system to keep this elephant of an economy and racial-societal relations balancing on a ball, you and your comrades are able to IMMEDIATELY step into the void and begin laying waste to our enemies, while simultaneously building our parallel society.

In summation you have a duty to be useful to the revolution, not useless.

EXTERNAL

As you can see what's important above all is revolution. If ever you see a comrade engaging in an act you deem immoral you need, simply ask yourself this one question: is this act counter-revolutionary? Which means is the general output of this comrade in the struggle anti-revolutionary? If it is then it is against the AWD's Moral Code. If it is not, then it is not against the AWD's moral code. In SIEGE James Mason speaks on how Joseph Tommasi's lifestyle was deemed immoral, wrong, against party principles, rules and regulations, and the general spirit of the organization. He wore his hair long, more in fitting with the times of mainstream society rather than those of his comrades, he smoked weed and had women sleep over at various party bases. This was deemed as absolutely abhorrent and antithetical to the regulations of the time. However, the NSLF (National Socialist Liberation Front) led by Tommasi was far more revolutionary than any other group of National Socialists post-Rockwell and pre-Pierce fully coming into his own. Would it then have been moral to drum Tommasi out of "The Movement"? Of course not.

Our moral obligation is not to pie in the sky ideals of total purity, but rather to boots on the ground ideals of total realism. For our part, we will tolerate no divisive moralism to hamstring our efforts.

This is the Moral Code of the AWD.

HOW TO CREATE AND OPERATE CELLS

The main idea of a cell is to be independent from all the other cells but work towards the same goal. That way, if one cell is compromised, none of the others can be affected, and the defective or inactive cell can be isolated from the rest of the group.

Members should be selected based on the following criteria:

- Should be visibly White-European.
- Should have firm uncompromising National Socialist/Fascist beliefs.
- Should be able to dedicate time and provide maximum input to the group.
- Minimum age is 18 to become an official member. The younger they are, the better. More room to radicalize and fewer risks of them being a sent provocateur and/or agent. Maximum age is 30.
- Are male. Revolution is a man's game. For females to be in supporting roles for a cell, they MUST meet one or both of the following criteria: are married to a member or are pregnant with a member's child/have children with the member.
- If over 26, should be able to provide history and proof of history of being a soldier for our cause.

Note that younger members are also more likely to be "going through a phase" rather than truly having radical beliefs cemented in their character. This should be noted moving forward while working with younger prospects.

VETTING

Vetting recruits for the struggle can be either the beginning or the end of your revolution. It matters not if you vet 99 solid National Socialists if one member of opposition makes it past your vetting. In that case your entire cell is compromised and doomed (not that 100 members would ever be in one cell. 100 members is enough to make 10 to as many as 20 cells). The four most common and dangerous type of infiltrators are federal agents, lower tier law enforcement, far left radicals, and right wing hobbyists/assorted part time revolutionaries.

You have selected people that you deem worthy of potentially working with online. What comes next? Getting to know the guys loosely and networking can all be done online, but the most important step is the IRL vetting process. This is where you will see how they present themselves, behave, and react to unpredictable situations. Any moderately quiet area with a good amount of privacy is a good place for a meetup. If meeting in a private area come prepared for a potential encounter with antifa or other left wing radicals. If meeting in a public area to ease the minds of both parties of this being an ambush, dress prepared for antifa to potentially take medium to long range, or perhaps even close range, photos of you in an attempt to doxx you. In the summer a baseball cap and sunglasses, in the winter a toque, a good either sweatshirt or jacket, and a neck warmer around your neck ready to pull up at a moment's notice.

Things to consider during a vetting meet are general appearance, demeanor, skillsets, initiative, level of knowledge about the worldview and the overall "gut feel" you have when talking with them for the first time. Believe it or not, but the intuitive overall feeling towards the person can be very telling. When in touch with Natural Order and Universal Truth your gut instinct is the universe and your ancestors reaching out from the ethereal.

If possible, have a trusted comrade come with you as a second opinion to help vet during a meeting. We can all make mistakes if we fail to maintain our objectivity, solely go off the "gut feel", or forget to address important questions.

VETTING - CONTINUED

It's important to be present in the place of vetting before the person you're vetting arrives, and to be familiar with the place and its geographic features. Also be familiar with escape routes and points of entry. Make note of the surrounding area, the people to frequent it, and any anomalies present. Opposition can very easily use this opportunity to strike at you with an array of techniques ranging from long distance photographing, to technological documentation of electronic devices of yours which connect to cell towers or wifi, to noting your biometrics (such as height, gait, demeanor), to even directly arresting or attacking you on scene.

MANAGING A CELL

DO

Assume anything you post online can be screenshotted, logged, and used against you in court. Years later even, and across all platforms.

Infiltrate enemy groups. Antifa and law enforcement always accept new applications.

Avoid vetting in short and frail members.

Avoid vetting in the unstable, mentally ill or those with destructive habits.

Think your group actions through, and have a game plan for when you hit the ground running.

Get to know what your fellow members are capable of doing. We all have at least one skill useful in this sphere, but no one is perfect at everything.

Show initiative to be active.

Develop bonds with your comrades. This is what keeps the trust and morale up in the cell.

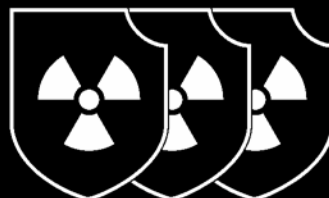

DON'T

Invite your drinking buddies to join. Separate fellow revolutionaries and your normie friends from one another.

Announce your plans, membership numbers, coordinates on any social media.

Reveal your name or any personal details to your cell members. This includes even your first name.

Share illegal materials in the chats. No pornography either.

Have anything illegal on your phone when the possibility of law enforcement encounter is high.

Fight with your fellow cell members over ridiculous drama. This is exactly what breaks functional groups apart and goes against the moral code of AWD.

Ever mess with people who have less than you to lose. If you do, everyone loses. The mentally ill, homeless, and deranged likely all have less to lose than you.

Take unnecessary risks. When the cons outweigh the pros, leave it.

Discuss details of operations or projects online. Sensitive matters always need to be addressed IRL.

Shitpost. Shitpost with your normie friends. When you're with your comrades, you should not feel the need for it.

LARP. This is not a theater or a circus. Take everything seriously with professionalism. However, it doesn't mean don't have fun.

MANAGING - CONTINUED

Leaderless resistance: There is no one leader, but a leadership

Members should not be told what to do by others, but rather take the initiative themselves and throw ideas around.

All cell members should be located within a reasonable distance from one another, to be able to meet at least on monthly basis. Any cell with too much geographic distance is destined to fizzle out, or fail catastrophically.

WHAT DOES A CELL REQUIRE TO FUNCTION?

For a revolutionary cell to function the following are all REQUIREMENTS:

Dedicated militants: self-explanatory. Those in the cell have to be serious about our cause and their willingness to engage in it.

Transportation: we are fighting a system with far more resources than us, and when it collapses it is still good principle to strike and move. Arrive, strike, depart. Arrive, strike, depart. Arrive, strike, depart. This requirement is even more important in countries which are geographically large.

Ammo: the more the better; but not so much that the militant avoids training in order to save more ammunition. A good rule of thumb is to buy in bulk, then save half and train on the other half. The militant, for instance, buys a thousand rounds then trains on 500 of them but puts the other 500 in storage.

Nonperishable food: at *LEAST* 6 months' supply. When you run under 6 months you are low and need to re supply. Having your own source of renewable food is more ideal, and requires the militant to learn basic gardening and how to take care of livestock. Chickens and meat rabbits are simple and can be kept in very urban conditions when needed.

A clean water supply: once again, at LEAST 6 months' supply. Ideally the militant has a means to filter his own water. Ceramic filters which work by means of gravity are most ideal.

Having a renewable supply and storage is fully necessary if the militant is going to utilize electronic devices for communications, observation, navigation, etc.

Means of communication: as secure as you can possibly manage. Custom encryption is best. When society collapses you can be more lenient but still practice the safest communication you can. Don't rely on the communication network you plan to destroy. Outside of digital communications, the means of analog radio communications should also be procured and learned.

Plans, back up plans, and the ability to remain flexible in operations: don't go into situations blind. Plan your actions meticulously. Have back up plans to these actions. Be prepared to abandon all plans and react on the fly. The best laid plans can go awry in a split second. War is chaos.

A FINAL EXPLANATION

A DIVISION'S PROTOCOL was originally written in 2018 as a primer for the ATOMBUCH. It was to be packaged as a type of brochure as passed around widely to pull potential militants in to reading ATOMUCH. While it was never released publicly, and even though AWD has been dissolved, it serves as a semi-unique collection of pointers and a framework for those looking to operate similar cells to AWD, The Base, FKD, Sonnenkrieg, etc.

YOU ARE A
DIAMOND IN
THE ROUGH
YOU ARE
A PEARL
AMONGST SWINE

Just as increased rarity in a given pool of objects causes the remainder to increase commensurately in value, so it is with we few remaining Aryans in blood, body, and soul.

Seeing how your own worth is incomparable even to vast swathes of the brown and yellow hordes, if you should decide to give your life to achieve Total System Death, be sure to make your blow a vicious and terrible one.

the hard

We still have much to learn from those we deem inferior

**blacks kill those who disrespect them, muslims kill those
who disrespect their prophet**

**they do it because they're animals with low impulse control,
thus this means their societies are doomed to be shitholes
we, on the other hand, have agency**

**applying this principle against outsiders and traitors would
make us masters of our fate in short order**

some food for thought.

"xenophobia",

"oscar",

"page 187"

reset

THE HARD RESET NATIONALISM - Oscar



When libs talk about nationalism (usually to smear it), they say that it was an invention of the french revolution in the 1790s to get more bodies for the military meat grinder. Okay, but that's CIVIC nationalism, which we all understand to be a controlled opposition strategy for this exact purpose.

Not exactly treading any new ground here.

ETHNIC nationalism - you know, ACTUAL nationalism, true to the meaning of the word? - has its roots in recorded history going AT LEAST as far back as the early 5th century B.C., when Greek city-states in

Asia Minor rose in rebellion against their Persian overlords, not due to mistreatment from the Persians, but due to the fact that they properly understood their occupiers as FOREIGN. When the mainland Greeks heard of this, they provided military and economic aid to their countrymen across the Aegean Sea, then the Persians invaded mainland Greece, were defeated, pulled back, only to get completely conquered by Alexander the Great over a century later, again on the basis of ethnic nationalism. In his campaign, Alexander frequently encountered Greek mercenaries fighting for the Persians.

These were rightfully recognized as traitors to their nation and treated accordingly. Outside of historical sources, the drive behind ethnic nationalism is as old as humanity itself. WE are the in-group, and who WE are is determined by our blood ties.

Those who aren't US don't receive the same good treatment as WE do, but those of US who go against the rest of US are traitors, worse than any enemy.

A DETAILED LOOK INTO THE TURNIER DIARIES

Dr. William Luther Pierce is perhaps the most influential man the Anglosphere has produced in the field of "White Nationalism"/Fascism/whatever you wish to call advocates of our race. A lot has been said about the man, but I feel that some of the underlying themes of his work have been undervalued.

To some, The Turner Diaries is just an exciting adventure novel, when it in fact uses several subplots as literary devices meant to convey a specific message. These subplots are:

1. The "responsible conservative" within The Organization
2. The Georgetown college kids
3. The reactionary General in Northern California

These three subplots are all different in terms of their contents, but the message Dr. WLP is trying to convey is this:

We can only rely on ourselves, and attempting to form alliances with those of others worldviews for critical tasks will result only in our demise.

1. THE "RESPONSIBLE CONSERVATIVE" WITHIN THE ORGANIZATION

Early on in The Turner Diaries, the protagonist Earl Turner is summoned to a meeting by The Organization, in order to deal with a traitor. The traitor is a conservative reactionary who managed to find his way into the position of leader within a cell, and who then attempted to refuse an order from Washington Field Command.

Upon questioning, the traitor Harry Powell is revealed to be a conservative, who does not seek to destroy the system, but force it to reform itself. He believed the violence employed by The Organization is meant to force the system into making certain reforms, rather than seeking to destroy it.

"...As Powell continued talking, it became clearer and clearer that he was a conservative, not a revolutionary. He talked as if the whole purpose of the Organization were to force the System to institute certain reforms, rather than to destroy the System, root and branch, and build something radically and fundamentally different in its place.

He was opposed to the System because it taxed his business too heavily. (He had owned a hardware store before we were forced underground.) He was opposed to the System's permissiveness with Blacks, because crime and rioting were bad for business. He was opposed to the System's confiscation of firearms, because he felt he needed a gun for personal security. His were the motivations of a libertarian, the sort of self-centered individual who sees the basic evil in government as a limitation on free enterprise.

Someone asked him whether he had forgotten what the Organization has repeated over and over, namely, that our struggle is to secure the future of our race, and that the issue of individual freedom is subordinate to that one, overwhelming purpose. His retort was that the Organization's violent tactics are benefiting neither our race nor individual freedom.

This answer proved again that he didn't really understand what we are trying to do."

W
A
R
G
T
H

"...his whole attitude, his whole orientation was wrong. As I listened to Powell I was reminded of the late-19th century writer, Brooks Adams, and his division of the human race into two classes: spiritual man and economic man. Powell was the epitome of economic man. Ideologies, ultimate purposes, the fundamental contradiction between the System's world view and ours-all these things had no meaning for him. He regarded the Organization's philosophy as just so much ideological flypaper designed to catch recruits for us..."

"...As it was, we had no real choice in deciding Powell's fate. There was not only his disobedience to consider, but also the fact that he had revealed himself to be fundamentally unreliable. To have one of us-and a unit leader, at that-talking openly to other members about trying to find a way to compromise with the System, with the war just beginning ... There was only one way to deal with such a situation.

The eight male members present drew straws, and three of us, including me, ended up on the execution squad. When Powell realized that he was going to be killed, he tried to make a break. We tied his hands and feet, and then we had to gag him when he began shouting. We drove him to a wooded area off the highway about 10 miles south of Washington, shot him, and buried him"

This subplot is a clear literary device, which begins the overall theme I am highlighting in this essay. This conservative did not share the worldview of The Organization, and yet he found his way not only into The Organization, but a position of leadership. The message Dr. Pierce is sending with this subplot is clear and poignant: do not share an organization (formal or informal), with those outside of our worldview. It is dangerous, it is pointless, and best it will temporarily sabotage the goals of said organization, at worst it will bring it all down. This was a relatively mild beginning of this theme, but the next example will escalate the seriousness of what happens when you violate the principle of

ONLY RELYING ON OURSELVES.

2. THE GEORGETOWN COLLEGE KIDS

Not too much later in The Turner Diaries, Earl Turner is in Georgetown, a formerly fancy upscale university town, when he notices a gang of mestizo subhumans attempting to abduct a cute redheaded girl named Elsa. He begins to walk towards them, which diverts their attention from Elsa, who manages to make her escape. Her and Earl later talk over burgers and fries, and she informs him that she is part of the Georgetown area communes. For a full explanation simply read The Turner Diaries, but basically the Georgetown area has divided into several communes based on either gender, a shared attitude, or simply convenience. Elsa is part of one particular commune, and gives Earl the address, as well as some information.

Slightly earlier in the book, Earl has the following conversation with Henry:

"...Another thing I talked to Henry about is the rash of relatively minor bombings which have occurred in the last two or three days. There have been a hundred or more of them all around the country, including four in Washington, and they have puzzled me in several respects, mainly the choice of targets - banks, department stores, corporation offices- but also their apparent amateurishness. For every bomb which exploded, it seems that the police discovered at least one which fizzled.

Henry confirmed my suspicions: the bombings-at least, those in this area-are not the work of the Organization. That is interesting. We seem to have unintentionally galvanized some of the latent anarchists-or God knows what-who have been lurking in the woodwork."

During Earl's conversation with Elsa, Earl asks about these sorts of people, and Elsa says the following:

"...She also gave me some good leads as to who is responsible for the recent bombings which puzzled Henry and me. It seems to be general knowledge among her friends that several of the Georgetown colonies are "into that sort of thing-you know, trashing the pigs."

Elsa herself seems to be completely apolitical and not concerned one way or another about the bombings. I didn't want to pry too much and make her think I was a cop, so I didn't push her for more information on the subject.

Under the circumstances I really couldn't afford to bring Elsa back to our headquarters with me-but I still had to fight the temptation. I slipped her a five-dollar bill when we parted, and she assured me she would find a place for herself in one of the groups without difficulty. Probably she would go back to the group she had left. She gave me their address, so I could look her up.

Thinking it over this evening, it seems to me that we may be overlooking some potentially useful allies among these young dropouts. Individually they are not very impressive, to be sure, but it may very well be that we can make use of them in a collective way. It bears further consideration."

One day Earl decides to drop in while in the area and check on Elsa, however he also visits with the secondary goal of seeing if he can convince any of the far-left crowd that constitute this general area into anti-system actions.

What's the worst that can happen?

"I shook my head in disgust, but this turn of our conversation gave me a convenient opening to the topic in which I was mainly interested. "A civilization which tolerates the existence of Kaplan and his filthy business should be burned to the ground," I said. "We should make a bonfire of the whole thing and then start over fresh."

I had unconsciously raised my voice loud enough for my last comment to be heard by everyone in the basement. A shaggy individual got up from his mattress in front of the TV and sauntered over.

"What can anyone do?" he asked, not really expecting an answer.

"Kappy the Kike's been arrested at least a dozen times, but the cops always turn him loose. He's got political connections. Some of the big Jews in New York are his customers. And I've heard that two or three Congressmen go up there regularly to visit some of the clubs he supplies."

"Then someone should blow up the Congress," I answered.

"I guess that's already been tried," he laughed, apparently referring to the Organization's mortar attack.

"Well, if I had a bomb now, I'd try it myself," I said. *"Where can I get some dynamite?"*

The fellow shrugged his shoulders and wandered back to the TV set. I then tried pumping Elsa for information. Which groups in Georgetown have been doing bombings? How can I get in touch with one of them? Elsa tried to be helpful, but she just didn't know. It was a subject in which she had no particular interest. Finally, she called out to the man who had strolled over earlier:

"Harry, aren't the people over on 29th Street, the ones who call themselves 'Fourth World Liberation Front,' into fighting the pigs?"

"Harry was obviously not pleased by her question. He jumped to his feet, glared fiercely at the two of us, and then stomped out of the basement without answering, slamming the door behind him."

THE
S
O
T
D

"...I guess I botched things rather badly. It was incredibly naive of me to imagine that I could just walk into the "dropout" community and be politely directed to someone engaged in violent and illegal activity against the System. Obviously, every undercover cop in Washington has been trying the same thing. Now the word must certainly be out everywhere that I'm a cop too. That blows any chance I may have had of making contact with anti-System militants in that particular milieu.

Of course, we could send someone else over to try to find the "Fourth World Liberation Front," whatever the hell it is. But I wonder now whether there's any point in that. My visit with Elsa has pretty well convinced me that, in the people who share her life-style, there's just not much potential for constructive collaboration with the Organization. They lack self-discipline and any real sense of purpose. They've given up. All they really want to do is lie around all day screwing and smoking pot. I almost believe that if the government would double their welfare allowances, even the bomb throwers would lose their militancy."

Earl realizes his mistakes, AFTER he made them however. Reminds me of a quote from SIEGE: *"never make the same mistake twice, if you can help it, don't even make it once".*

Sometimes, one is enough.

Later on in the book, Earl's unit is raided by the System, and he is taken into custody. While in custody, Earl is brutally tortured. He is beaten, burned, cut, and has a pipe inserted into and shoved up his rectum. He tells them everything they wish to know. This is a much more brutal example of the same theme Dr. Pierce was attempting to convey earlier, with Harry the mutineer. Earl attempted to rely on not only an outside worldview, but an opposing worldview. It later comes to light that one of the Georgetown dropouts ratted on Earl, which resulted in Earl being followed back to his unit's HQ, and the subsequent police raid and torture.

These are not random subplots inserted for no reason. Dr. Pierce is intending for them to be literary devices meant to impress upon the reader the theme of *****ONLY RELYING ON OURSELVES***** and the consequences of when you violate this rule.

3. THE REACTIONARY GENERAL IN NORTHERN CALIFORNIA

This is a brief point, but still illustrates the overall theme Dr. Pierce was attempting to instill in his readers with this subplot. In the final third of *The Turner Diaries*, The Organization has taken control of Southern California. As the entire nation, but especially California, is in flux, an American General takes control of Northern California. He is anti-The Organization, but also anti-System. This General spout reactionary conservative talking points. He wishes a return to "law and order" and the constitution. He wishes to turn back the clock to a previous era, forgetting or more likely not even realizing, that that previous era is what led to this current one.

Because the situation is so fluid, The Organization sends a delegation to meet with the rogue General in order to work out a power-sharing agreement (temporarily). Asterisks once again inserted by the author of this essay to highlight the critical part.

*"The biggest fly in our ointment is northern California. Things are completely out of control there. General Harding has really botched the situation. ***It serves us right for having anything to do with a conservative***; he, like all the rest, was standing behind the door when the brains were passed out, and so he got a double dose of pigheadedness to make up for it. (Note to the reader: Turner is referring to Lt. Gen. Arnold Harding, commander of Travis Air Force Base, which was located about halfway between San Francisco and Sacramento. Harding's role in the Great Revolution, though important, lasted only 11 weeks; he was finally assassinated by an Organization team on September 16, 1993, after several earlier attempts failed.)*

ORGANIZATION

If the situation in the San Francisco-Sacramento area doesn't improve soon, we're likely to be involved in a civil war against the troops under Harding. The System would really love that. The only thing Harding has done right so far was breaking with Washington during the first week of our July 4 offensive, as soon as it became clear that the System had lost its grip in California. On his own initiative he declared an independent military government in northern California and got nearly all the other officers in military units stationed there (except our own undercover military people, of course) to go along with him.

Revolutionary Command made the strictly practical decision to let General Harding carry the ball in his area, and our people were instructed not to oppose him. This had the effect of substantially reducing our own losses, although the military has actually suffered many more casualties in northern California than in the south. This is because Harding has failed to take sufficiently radical measures to consolidate his authority and to deal with Black military personnel.

And he has failed utterly to get the civilian population under control-again, because he seems unable to understand the necessity for radical measures. The Jews and the other Bolshevik elements in San Francisco are running circles around him, and the Chicanos in the Sacramento area have been rioting more or less continuously for a month.

When a delegation of Organization people went to Harding last month and suggested a joint Organization-military rule for northern California, with Harding's forces handling defense matters and the Organization handling civilian matters - including police functions, Harding arrested them and has refused to release them. Since then, he has been issuing idiotic proclamations about "restoring the Constitution," stamping out "communism and pornography," and holding new elections to "re-establish the republican form of government intended by the Founding Fathers," whatever that means."

It serves us right for having anything to do with a conservative, says Dr. Pierce via Earl Turner. These three sections of The Turner Diaries are meant to illustrate the danger of placing the future of our race in the hands of any foreign worldview or cause. This struggle is ours to bear, and anytime during the book that foreign ideologies interact with/within The Organization, it ends disastrously.

IN SUMMARY

1. A conservative within The Organization who managed to sneak into a leadership position attempts to defy an order from above, and tries to make his entire unit mutiny.
2. An attempt by the protagonist to ally with anti-System leftists gets his unit raided, valuable resources lost, and him brutally tortured by the system.
3. An attempt to ally with a conservative anti-System faction gets an entire delegation of The Organization arrested, at a critical time when manpower was most needed and least could be spared.

The theme Dr. Pierce is attempting to instill in the minds of the readers is simple: **RELY ONLY ON OURSELVES FOR CRITICAL TASKS.**

Finally, to end my essay here on some undervalued themes of Dr. William Luther Pierce's various works, I will explain his central theme. The number 1 takeaway he wanted from his readers, listeners, followers. What he wanted those of our race who are racially minded above all else to understand: **PERSONAL AND RACIAL RESPONSIBILITY.**

He wanted YOU, yes, YOU, to understand that our freedom is only possible through people like YOU taking ACTION. He didn't want excuses, he didn't want dillydallying, he wanted men (and women), who were willing to take action to make our dreams a reality.

I will try to not belabour the point here with excessive quotes and links, but if you are a serious and dedicated White revolutionary, then you have either already listened to and read lots of Dr. Pierce's work, or you will after reading this essay. When listening/reading to his work, pay attention to the theme of self and racial responsibility, it is omnipresent in all of the good doctor's works.

You can find an archive of his radio broadcasts on telegram here: https://t.me/WLP_Archive

I recommend searching within the WLP Archive for "How Not To Be A Coward". A 2.5 minute clip as short as it is poignant.

"Listening and reading must be a preliminary to action."

You can find the PDF and audiobook of The Turner Diaries here: <https://t.me/TheTurnerDiaries>

A short quote from The Turner Diaries really exemplifies this specific theme of not just knowing the problems, but having the ability and desire to solve them. Asterisks inserted by the author of this essay to highlight the really critical part.

*"It is really only a minority of a minority which led our race out of the jungle and along the first few steps toward true civilization. We owe everything to those few of our ancestors who had both the sensitivity to feel what needed doing and the ability to do it. ***Without the sensitivity, no amount of ability can lead to truly great achievement, and without the ability, sensitivity leads only to daydreams and frustration. *** The Organization has selected from the great mass of humanity those of our present generation who possess this rare combination. Now we must do whatever is necessary to prevail."*

One final quote to highlight this central theme of Dr. WLP's works. A radio broadcast generally titled "Dreaming Of A Future World".

"In these talks I have with you every week, I try to choose topics of current interest. Topics that are in the news, or should be in the news, because it's important for all of our listeners to understand that the things we talk about in these broadcasts are real, and relevant, and they demand our attention *now*. They are things that listeners can check on themselves if I tell them where to check. Even when I choose to talk more about ideas than about current news, I try to tie the ideas into events either current or historical, in order to keep listeners aware that the ideas are relevant, that they have consequences in the real world. I want everyone always to have in mind that the essence of these broadcasts is not entertainment, and it's not even education. It's survival, it's our whole future. It's the continuation of the process of life that began on this earth hundreds of millions of years ago, and is now on the brink of disaster.

"The reason I make these broadcasts is to move people, our people, to accept responsibility for where the process is going. To help pull it back from the brink. To deal decisively with those people and policies which pushed it to the brink, and then help to guide it back to an upward path again."

That was why Dr. Pierce did everything he did. His books, his broadcasts, the National Alliance and all its attendant newsletters and propaganda, everything he did was to convince spiritually sound White men and women to take action against the enemy. Not just listen to the truth, but take action to enforce the truth upon this sick, corrupted, jewish occupied western civilization, and free our race.

By no means have I covered all the themes of Dr. Pierce, this was a brief essay on how the Turner Diaries is more than just an exciting and moralizing adventure novel, and the central tenant of the worldview of Dr. Pierce. Throughout all his works, but especially The Turner Diaries, Dr. Pierce expounds on important ideas. The meaning of worldview-as-faith, the benefit and strategy of political terror, the importance of revolutionary vs stagnation. While The Turner Diaries were written in 1975-78, the concepts discussed within are timeless. I encourage all White revolutionaries to study the works and legacy of Dr. Pierce - and then to honor it with action.

WHITE REVOLUTION IS THE ONLY SOLUTION!!!

2041

A SPACE ODYSSEY

THE COBRA MOBILE ARTILLERY CRAFT FLEW ABOVE THE EARTH'S SURFACE, PAYLOAD READY - A MASSIVE METAL ROD ACCELERATED USING AN ELECTROMAGNETIC LAUNCHER, CAPABLE OF SPLITTING THE GROUND WITH EARTHQUAKES OR DROWNING ENTIRE COASTAL CITIES IN MASSIVE MEGATSUNAMIS. THE IMPERIUM'S FLEET CONTAINED MANY SUCH CRAFT, DESPITE ITS YOUNG AGE - WE HAD TO DEVELOP STANDOFF WEAPONS CAPABLE OF DEFENDING THE INTERESTS OF OUR RACE THROUGH DETERRENCE OF ENEMY ACTION, AT LEAST WHILE WE CONSOLIDATE THINGS ON THE HOMEFRONT.

I'VE SEEN THE FOOTAGE ON THE PROPAGANDA CHANNELS. ENTIRE CITY BLOCKS ABLAZE WITH HEAVY ARMORED UNITS MOVING IN TO HAND OUT EVICTIONS IN THE FORM OF HOLLOWPOINTS. THE INVADERS DIDN'T EXPECT TO BE GREETED WITH LIVE AMMO, NOT AFTER YEARS OF BEING ALLOWED TO DO AS THEY PLEASE ON THE WHITE MAN'S DIME. THE FIRST FEW CITIES RESISTED - BRUSSELS, PARIS, FRANKFURT, TO NAME A FEW - BUT AFTER TENS OF THOUSANDS OF THEM WERE GUNNED DOWN TO MAKE AN EXAMPLE OUT OF THEM, THE REST FOLLOWED OUR EVICTION ORDERS MUCH MORE MEEKLY, REDUCING THE WEEKLY DEATH-TOLL INTO THE HUNDREDS. BOATS SEIZED FROM TRAFFICKERS - WHOM OUR SOLDIERS DECAPITATED UPON CAPTURE AND PUT THEIR HEADS ON SPIKES BACK ON AFRICAN SOIL - WERE USED TO FERRY THE INVADERS BACK ACROSS THE SEA. KILLING THEM MIGHT HAVE BEEN EASIER, BUT THE INFLUX OF HUNGRY MOUTHS WITH NO ROOF ABOVE THEIR HEADS MAY JUST DESTABILIZE THE SOUTHERN MEDITERRANEAN TO THE POINT OF TOTAL COLLAPSE, AT WHICH POINT WE WILL RECLAIM IT AND PUSH ITS OCCUPIERS INTO THE SANDS OF SAHARA.

THE IMPERIUM DIDN'T HAVE PLANS OF OPEN, AGGRESSIVE EXPANSION FROM THE VERY BEGINNING, BUT CIRCUMSTANCES FORCED OUR HAND. THE USUAL CULPRITS OF THE CAUCASUS, ARMENIA AND AZERBAIJAN, WERE YET AGAIN EMBROILED IN CONFLICT, AND WE HAD OUR SIGHTS SET ON BUILDING A BRIDGEHEAD IN THAT REGION AS WELL, IN ORDER TO FLANK THE T'RKIS AND JEWS AND RECLAIM ANATOLIA AND THE LEVANT. CHOOSING SIDES IN THE CONFLICT WAS AN EASY MATTER - DESPITE CENTURIES OF RACIAL ADULTERATION, ARMENIANS HAVE ALWAYS BEEN OUR RACE'S NATURAL ALLIES IN THE REGION, FROM THE TIME OF THE ROMANS TO THE CRUSADES AND BEYOND. WE WILL MAKE SURE TO SEND A FEW PLEBEIANS THEIR WAY TO IMPROVE THEIR GENETIC STOCK. AZERIS, ON THE OTHER HAND, ARE A T'RKIC MUDBLOOD BREED, AN ALLIANCE WITH WHOM IS OUT OF THE QUESTION.

ISOLATED FROM THEIR ALLIES FROM NATO - AN ORGANIZATION EXISTING IN NAME ONLY AT THIS POINT - AZERBAIJAN'S EFFORTS WERE MUCH MORE EASILY FRUSTRATED IN THE MOUNTAINS, TO THE POINT OF GIVING OUR SPACE FLEET ENOUGH TIME TO INTERVENE. IT WAS OUR PARTICULAR SHIP'S HONOR OF LAUNCHING THE FIRST STRIKE OF OUR GRAND ENTRANCE TO THE CONFLICT - OUR EXPEDITIONARY FORCE WAS POSITIONED IN THE CAUCASUS MOUNTAINS WITH ORDERS TO STRIKE SOUTH AT THE MOMENT THE BARRAGE HIT:



"WHAT'S THE STATUS?"

THE COMMANDER'S VOICE COMES INTO MY EARPIECE. CLEAR AS DAY. I LOOK OVER OUR TARGET AREA ONE MORE TIME - A PATCH OF THE CASPIAN SEA JUST TO THE EAST OF THE CAPITAL CITY OF BAKU. IMPOSSIBLE TO MISS. "READY TO PROCEED, SIR."

"HELLO?"

DID HE NOT HEAR ME? I TRY TO FOCUS ON THE CONTROLS OF THE SHIP'S CANNON, TRYING IN VAIN TO MAKE OUT THE LABELS. WHAT'S GOING ON?

"ARE YOU SLEEPING ON THE JOB AGAIN, JOHNSON?"

I SNAP AWAKE AT MY DESK IN THE OFFICE, MY BOSS STANDING ABOVE ME, WITH A SLIGHTLY AMUSED EXPRESSION ON HIS FACE.

"THOSE NUMBERS WON'T FUDGE THEMSELVES, SEE? IF YOU WANT TO KEEP YOUR JOB, THE FIRST STEP IS TO KEEP THE BUSINESS AFLOAT, AND THAT REQUIRES STAYING ONE STEP AHEAD OF THE IRS. CAPISCÉ?"

"YES, SIR. SORRY, SIR."

I BLURT OUT, TRYING TO CONCEAL MY EMBARRASSMENT. GETTING FIRED NOW WOULD SERIOUSLY INTERFERE WITH THE BUDGET FOR MY BASEMENT RAILGUN EXPERIMENTS.

"YEAH, YOU BEST KEEP IT MOVIN'. THERE'S FUCKIN DONUTS IN THE BREAKROOM AFTER YOU'RE DONE WASTING THE BUSINESS MONEY."

DECLARATION V

THE CANOPY OF TREES ABOVE DARKENS YOUR SURROUNDINGS;
CRIMES THAT NEED TO HAPPEN NO LONGER SEEM UNJUSTIFIED TO YOU

I
PRESENT
I

007-045

II
FUTURE
II

046-084

III
IMPERFECT
III

085-121

IV
PERFECT
IV

122-176

V
FUTURE PERFECT
V

177-237

VI
PLUPERFECT
VI
HARD RESET

238-253

DECLARATION V INFORMATION

DELTA - 1 PASSAGE
FOXTROT - 1 PASSAGE
GOLF - 3 PASSAGES
HOTEL - 4 PASSAGES
KILO - 2 PASSAGES
MIKE - 3 PASSAGES
OSCAR - 19 PASSAGES
QUEBEC - 1 PASSAGE
SIERRA - 1 PASSAGE
TANGO - 2 PASSAGES
UNIFORM - 1 PASSAGE
WHISKEY - 6 PASSAGES
YANKEE - 5 PASSAGES
ZULU - 3 PASSAGES
TOTAL - 52 PASSAGES
61 PAGES

007 046 085 122 177 238



Hivemind

"go on, big, guy, show us how it's done. put up or shut up."

first off - careful what you wish for

second - lone wolf attacks spaced out months apart form a pattern only really picked up on by the System's all-watching eye

a sleepwalker is unlikely to wake up if a twenty-something White man with no roots in his "community" shoots up a soft target every few months

but a string of bombings and assassinations against abortion clinics, or pharmacies, or vaccination sites, or political parties? that's a pattern anyone can see clear as day

this pattern either requires the kind of super-man who only comes around so often, or action from several like-minded individuals tapped into a larger hivemind, whether in direct communication or (preferably) not

our job is to build that hivemind and make sure it doesn't get broken up by bickering brought about either by internal differences or external pressure

OSCAR

T
H
E
H
A
R
D
R
E
S
E
T

Morning

It's Friday morning and my drive to work (I don't pay taxes) gets my brain wondering if I live in the worst suburb in NOWHERE or if all of them in this country have mocha colored teenage boys walking around with street shitter teenage girls (seeking together to drift even further from God genetically).

I even pass some horrible modern art display, I can't really describe it; but all it really provokes from me are two quiet words - "among us".

An old chinawoman walks her small expensive dog by me in her crusty bathmat bath robes. She doesn't appear to have bathed in weeks.

The way I drive, I'm through it all quick... But just because I left the suburb doesn't mean these affronts to God have disappeared. An album comes on- it's ACRYLICS - SINKING IN - and at right about that first drop (if you know it, you know it) I decide that from now on, the sidewalk will be the road for me. I'll practice my Charlottesville drift a little. My enemy's children will grow to be my own enemies afterall.

FOXTROT

VIOLENCE BEGETS VIOLENCE

WOE BEGETS WOE

MURDER FOR MURDER

BLOW FOR BLOW

THEY BUTCHER OUR KINSMEN

PRAY TO STEM THE TIDE

WE SLAY THEIR CHILDREN

NEVER TO BE DENIED

VIOLENCE IS KING

ON THIS DOWNWARDS POINTED EARTH

THEIR NECKS WE SHALL WRING

TO COMMENCE OUR REBIRTH

**P
O
E
T
R
Y
||
K
I
L
L
O**



NATURAL BEAUTY

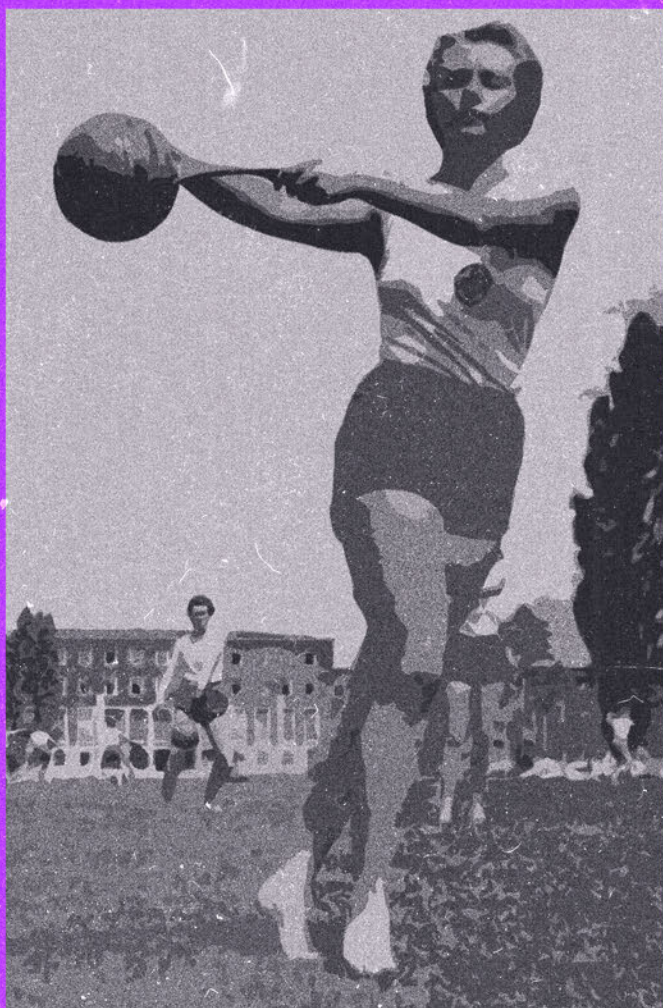
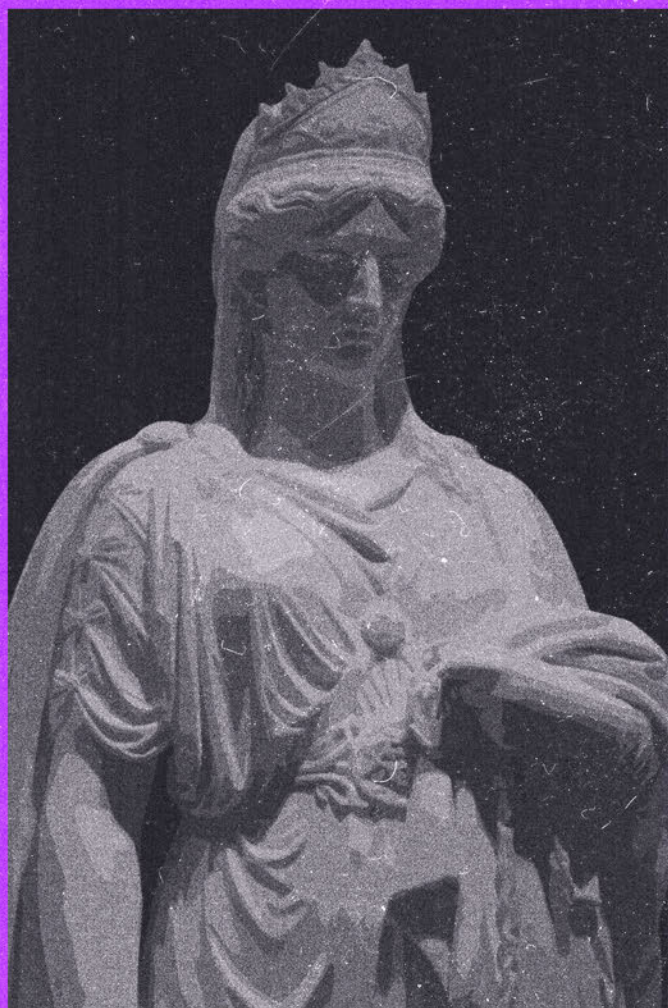



Every overweight pound a woman carries around with herself, is another 15 minutes and 15 dollars she has to spend to look acceptable to go outside.

12 pounds overweight?
She's gonna be a few hours late.
Don't bother with her.

30 pounds overweight?
She won't see the sun until morning.

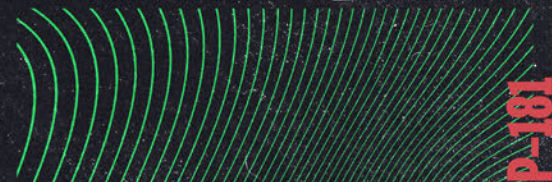

"START LOOKING
AT THE WORLD
YOU'RE LEAVING
YOUR KIDS."

- Sandra Good



"DO WHAT YOUR
LOVE TELLS YOU
TO DO."

- Charles
Manson

POLLUTION

They're killing our Planet. They're killing our People. Pretty soon it won't be nothing but a filthy, brown sinkhole. Through forced miscegenation and forced deforestation they're ensuring our total, absolute obliteration.

CORRUPTION

Everywhere you go, everywhere you look, traitors all abound and we're ruled by colored crooks. Kikes control the money, niggers control the streets, we die day by day as slaves while our traitors loudly feast.

UNREALITY

Technology helped make us second class, there's cement everywhere there's supposed to be grass. Thought censorship and human programming. We're enslaved by billionaires who can't even piss standing.

- Uniform



182

REVEREND
MARTIN
LUTHER
KING
JUNIOR

THE TRUTH WILL SET YOU FREE 1/3



POLITICAL TRAITORS
hail ernst



OCCUPATION GOVERNMENT
hail roof



ENSLAVEMENT OF WHITES
hail ray



ECOLOGICAL DESTRUCTION
hail kaczynski



BILL GATES IS MORTAL
hail YOU!

"Look at the roots of these problems. Many people all over the world are due to be assassinated. This is just the beginning."
- Sandra Good

"Any attack on any lie is justified. Any attack on anyone who puts money and lies before people's lives is justified."
- Sandra Good



We have a responsibility to our dying People and our dying Planet to kill all LIARS!
All politicians, govt employees, judges, PIGS.
All tech CEOs, all NGO workers/civil rights advocates, all celebrities, all those that pollute our earth for their own economic gain.
- Uniform



Stab them to death in their homes and offer their blood to our old gods

Shoot racemixing couples in the streets out of Buicks

Lynch politicians on the outskirts of their summer home properties

Burn down the homes of refugee advocates with them inside

Fill your truck with homemade angry plastic and drive it into technocrats' living rooms

Call in false burglaries to 911 just to ambush responding pigs from across the street

Uniform

We have to uphold things they don't even think about.

Burn fires in their cities with your minds eye.

YOU KNOW WHAT TO DO.

HARD-
RESISTANCE

184

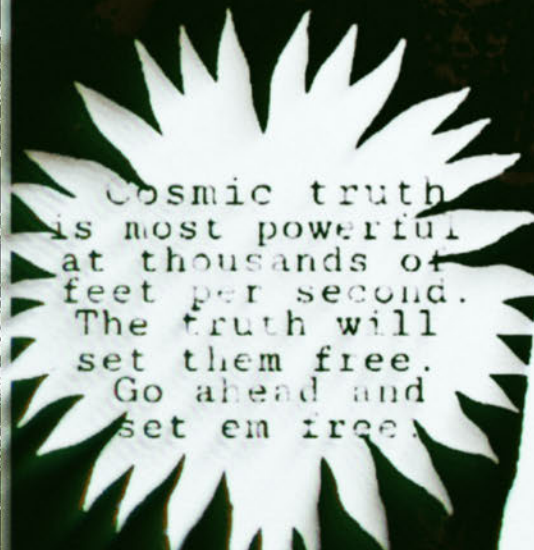

Cosmic truth is most powerful at thousands of feet per second. The truth will set them free. Go ahead and set em free.

THE TRUTH WILL SET YOU FREE 8/3



**YOUR SOLUTION TO THIS PROBLEM
INVOLVES DEPORTATION.**



MINE INVOLVES BALL BEARINGS.



WE ARE NOT THE SAME.



How long can you coward in terrifying opposition? Fear, Suppression, Coercion. We deficate on the pride and effort of our forefathers every day we fail to oust our oppressors. Condemn those of derrision, light a fire under your fellow man. Will he be thrown from his fear or will flesh sear?

YANKEE



NEXT
OF
KIM

HOMESTICK FOR A PLACE I'M NOT EVEN SURE EXISTS

THE HARD RESET

187

OSCAR

Summer rain washes over the cobblestones and fills the air with the smell of the forest. The younger, less experienced recruits run for cover, but us veterans of the monastery have long ago grown used to the elements - compared to the unending scorching from the sun we had just a few days ago, or the freezing snow that falls five feet deep, a light drizzle such as this one is nothing to worry about.

Over all, having been separated from civilization for this much time makes a man less prone to worrying about everything. When you wake up at sunrise and can't get a drink of water if nobody has bothered to draw it from the well, you get a much sharper perspective on life. When craving food for taste's sake alone can only be satisfied through putting down whatever you're doing, going outside to the orchard, then remembering that it's only April and no fruit has grown yet, you learn discipline.

We do eat like kings, though. The first step to maintaining order is to fill the stomach - the calmest man turns into a wild beast when hungry. To prevent this, we raise animals - cows, pigs, and sheep - and tend to a fruit orchard with trees and bushes.

Our purpose in this sanctuary is a dual one - spiritual and practical. Ora et labora. Here, in the wilderness, we feel a much stronger connection to God's creation, rather than the hubris of Man that one finds in the city. Natural Law may be unwritten, but here, everyone learns it the hard way - if you don't work, you die. We have no room for dead weight.

There's always work to be done around here, even when we subtract prayer and tending to our food stock. Transcribing books by hand has gone the way of the dodo, these days we employ technology to digitize them and make them available to the root drones who dwell in the belly of the Beast. This process involves much elbow grease and attention to detail, which makes the scribes memorize each work they digitize much more thoroughly than if they had only read it.

Our use of technology does not end there. We employ tools to manufacture weapons for the struggle, most of which are smuggled back down into the filth of civilization, some of which we keep for training purposes. Our trade with the resistance fighters earns us some of the amenities we'd have trouble procuring on our own - sources of electricity, mostly. Our operation consumes more than it produces, at least in this regard.

THE HARD RESET

Those, for whom manual labor does not pose enough of a challenge, occupy themselves by building up their bodies, growing stronger with each passing day. Others still spend countless hours in discussion with their colleagues on topics ranging from philosophy to military strategy. Some apply themselves creatively as painters and sculptors, though other forms of artistic pursuits are better facilitated in other places.

Isolated from the World, we uphold what might be God's least-appreciated commandments. Our solitude reminds us that we are not of this world, we grow ever more detached and ultimately, disgusted with the degeneracy below us.

Isolated from the World's distractions, we make much more progress in a shorter time than would be possible in ordinary circumstances. Our recruits enter as boys and within weeks, the hard labor and strenuous exercise first shape their bodies, then intellectual pursuits sharpen their brains, until, within only a couple of years, they emerge as not mere men, but HEROES beyond recognition, ready to bend the whole world according to the principles of Our Struggle. Humbled by their environment, equipped with the Will, the Way, and the Means, they are an unstoppable force aimed straight at modernity's weakest points.

The rest of us have grown fond of living this way, guiding fresh recruits along the path of self-mastery for years. Once the day comes, however, when the best and brightest of our men calls upon us to follow Him into battle for the future of Our People, we will pack up and go wherever He leads us, confident in Our Victory.

Too many urge us to remain holed up and leave the World behind, but we can't bring ourselves to agree. The Enemy has done enough evil and only continues to do more with each passing moment. His downfall is inevitable - before all is said and done, God shall secure final victory. Until then, however, it is up to us to check the spread of the rot with all the power we can muster. A generation that lets those who come after it fight their battles alone is like a father who abandons his children for fear of his own inadequacy.

OSCAR

HOMESICK FOR A PLACE I'M NOT EVEN SURE EXISTS, 188

I A POLITICAL STATEMENT

[REDACTED]

gets on the podium to speak. The audience is rather timid, made up mostly of urban rabble. Mostly.

The System's mouthpiece starts off with the usual filler about how glad he is to have such a great turnout (I could have attracted more people than this with a hotdog stand on a Tuesday morning) and how great it is that we're all united in our opposition to the increasing levels of violence mostly aimed at public servants (we're not, but more on that later).

You see, a U.S. embassy guard was shot dead three days ago and the culprit remains at large, their identity unknown. The guard was a hired gun out of Honduras, no idea what he was doing in a lily-White European country. Any tourist off the street would have been less conspicuous as an outsider. The guard's body was stuck in a dumpster, his pants sagged below his asscheeks, his weapons and identification stolen. These pieces of information were conveniently left out of the System media's reporting on the event.

How do I know this? Well, I'm the guy who wasted the son of a bitch.

I attracted his attention by pretending to be drunk and running off with the rainbow flag flown by the embassy, then I led him on a chase down a dark alleyway, turned around and pumped him full of lead from a homemade submachinegun. The suppressor - also homemade - took care of most of the noise, the rest blended in decently well with the other miscellaneous sounds of the city. I stuffed the poor bastard in the garbage, took everything valuable, pulled down his pants for extra humiliation, then got away and returned to a safe house within an hour of the shooting. Smooth operation, if I do say so myself.

OSCAR

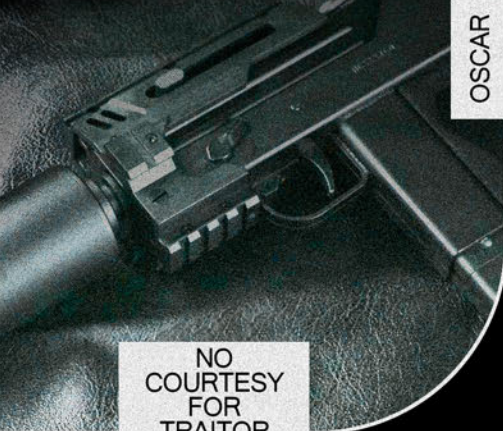

NO COURTESY FOR TRAITOR POLITICIANS

GETTING CLOSER

II

The speech drags on, filled with platitudes about civic unity and standing up to terrorism and blah blah blah. I couldn't imagine being in charge of writing these guys' checks, I could entertain a crowd more easily by making armpit fart noises. Indeed, within just the space of fifteen minutes I can feel the audience's attention waning, a couple talking to each other here, a guy leaving there. I can't wait to make my move.

The floor is opened up for heartfelt comments. The city's mayor walks up and says even more of the same bullshit that we've already had the misfortune to hear. A random woman tries to hold back tears as she pretty much begs us all to just hold hands and sing kumbaya as our children get preyed upon by trannies. A random faggot gets on stage and publicly thanks the U.S. embassy for sponsoring last year's sodomy pride march. He's gonna get flamed in the group chat by homos who still pretend to be revolutionaries, that's for sure.

I take my turn on the microphone, completely no screening required despite my proximity to major political players in the area. I give the microphone a tap to see if it works, then turn to the public. "Have you noticed that we only really have these demonstrations whenever one of THEM gets killed? Have you wondered why OUR murder victims never seem to get much attention from the media and the political class? Just last week, a father of three was killed not far from where we stand now and his death didn't make any headlines. Did you pour out into the streets then? Did any of you offer support to his grieving family, his crying children?"

OSCAR



HR

III

Murmurs from below. No more quitters - I've captured their attention. Good. That will be useful for what's to come. "Whatever we do, things get worse. Whoever we vote for, THEY get their way while WE lose more and more. Every new headline has us at each other's throats while the political class consolidates their gains and imports new streams of dependable voters, who live in OUR country as invaders on OUR dime."

Other than a few gasps, the audience greets me with a deathly silence. The murmuring is starting to come from behind - the paid piggies of the System sharing the stage with me. I turn to the mayor, still holding the microphone.

"We've made our demands through the ballot box. Every election, the status quo gets trounced and a new, phony controlled opposition party or candidate replaces it and proceeds to fuck us over. Well, here's one political demand that you will find much harder to ignore, sir. My dear political representative, I am asking you to DIE."

His shocked and horrified expression is dashed by a bullet between his eyes, coming from my pistol, the same one I took from the embassy guard. He drops to the floor like a sack of potatoes. Good riddance.

Absolute mayhem ensues. A stampede begins to build in the crowd, while the two cops assigned to this event quickly draw their weapons. Before they can fire them, they too are shot dead - not by me, but by my trusted brothers-in-arms implanted in the audience below, one of them wielding the submachinegun I used on my last operation.

The chaos thickens. The boys and I collect the pigs' weapons and make a hasty escape with the rest of the crowd. Good thing all of us are wearing masks to stop the spread of incriminating photographic evidence through the media.



THE HARD RESET

INFANTICIDE — Oscar

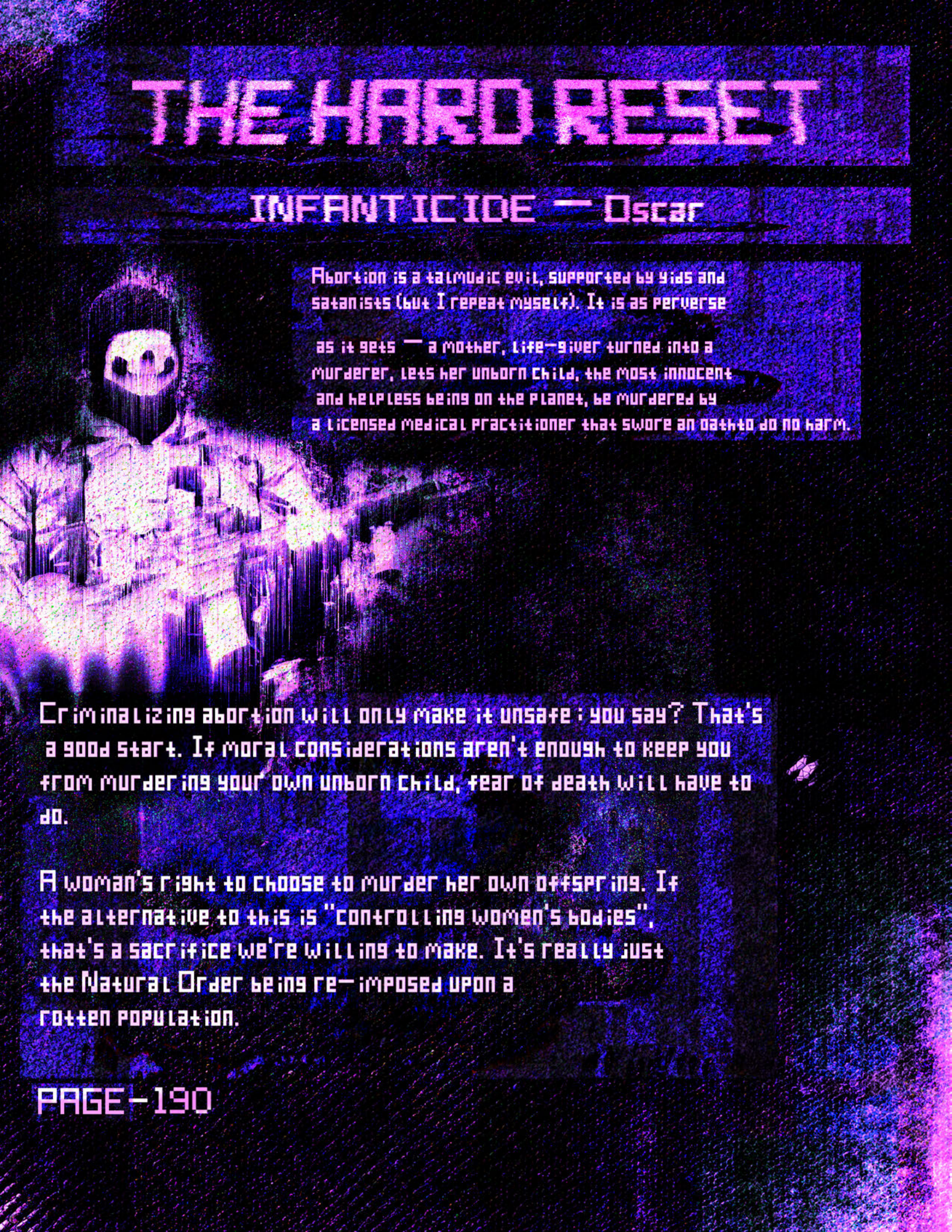

Abortion is a talmudic evil, supported by yids and satanists (but I repeat myself). It is as perverse as it gets — a mother, life-giver turned into a murderer, lets her unborn child, the most innocent and helpless being on the planet, be murdered by a licensed medical practitioner that swore an oath to do no harm.

Criminalizing abortion will only make it unsafe; you say? That's a good start. If moral considerations aren't enough to keep you from murdering your own unborn child, fear of death will have to do.

A woman's right to choose to murder her own offspring. If the alternative to this is "controlling women's bodies", that's a sacrifice we're willing to make. It's really just the Natural Order being re-imposed upon a rotten population.

ABORTIONISTS

THE ONLY
DEMOGRAPHIC
MORE DEADLY
TO NIGGERS
THAN NIGGERS
THEMSELVES

Hard Reset

Oscar

P-191

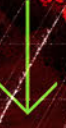

THE HARD RESET

"Damn bro, you're really gonna let them talk to you like that? You're really gonna let them get away with it?"

Your friends and instigators stand behind you, escalating the conflict and urging you to issue a long-overdue vibe check.

We've all been in this situation - some loudmouth cunt or punkass piece of shit is running their fucking mouth, causing a scene and being a nuisance. They're insulting you personally, with smugness that indicates they've never been knocked out, hospitalized or otherwise HELD ACCOUNTABLE.

This explains the current dynamic between Whites and our many racial and political enemies, under the beast System. They engage in state-sanctioned anti-White attacks, transgressions and bastardizations with impunity. With a sickeningly entitled attitude, they boast about what they've done and continue to do. They throw it in our faces precisely because we've allowed them to. To them, it's personal. Coddled and spoiled rotten by the State; shielded from just consequences; they feel untouchable. It shows.

A PRIME EXAMPLE: THE HOMOSEXUAL PLAGUE

HOW IT STARTED: "Equal rights" and fag marriage

HOW IT'S GOING: Fag parades; drag queen story hour; child grooming; pozzed brainwashing in school and pop culture; puberty blockers and hormone injections; genital mutilation; whole ass men in women's restrooms, sports and prisons; rainbow flags everywhere - and these self-righteous queers demand our enthusiastic support every step of the way.

Enough will NEVER be enough. These vile, AIDS infested perverts CANNOT be appeased. NEVER CAPITULATE. Compromise is a death wish. Diplomacy is dead. VIOLENCE - that is, ACCOUNTABILITY BY FORCE - is the only way out of this hell.

"Damn bro, you're really gonna pretend this is okay? You're really gonna let faggots live and work near you and your kids when you've got a loaded rifle in your gun safe? You're really gonna let thousands of rainbow flag-waving soft targets gather in a fenced-in, open air venue and flaunt their faggotry openly and publicly? For a whole weekend? You're really gonna let them walk outta here and make it home safe? ALL of them?"

Damn bro..."

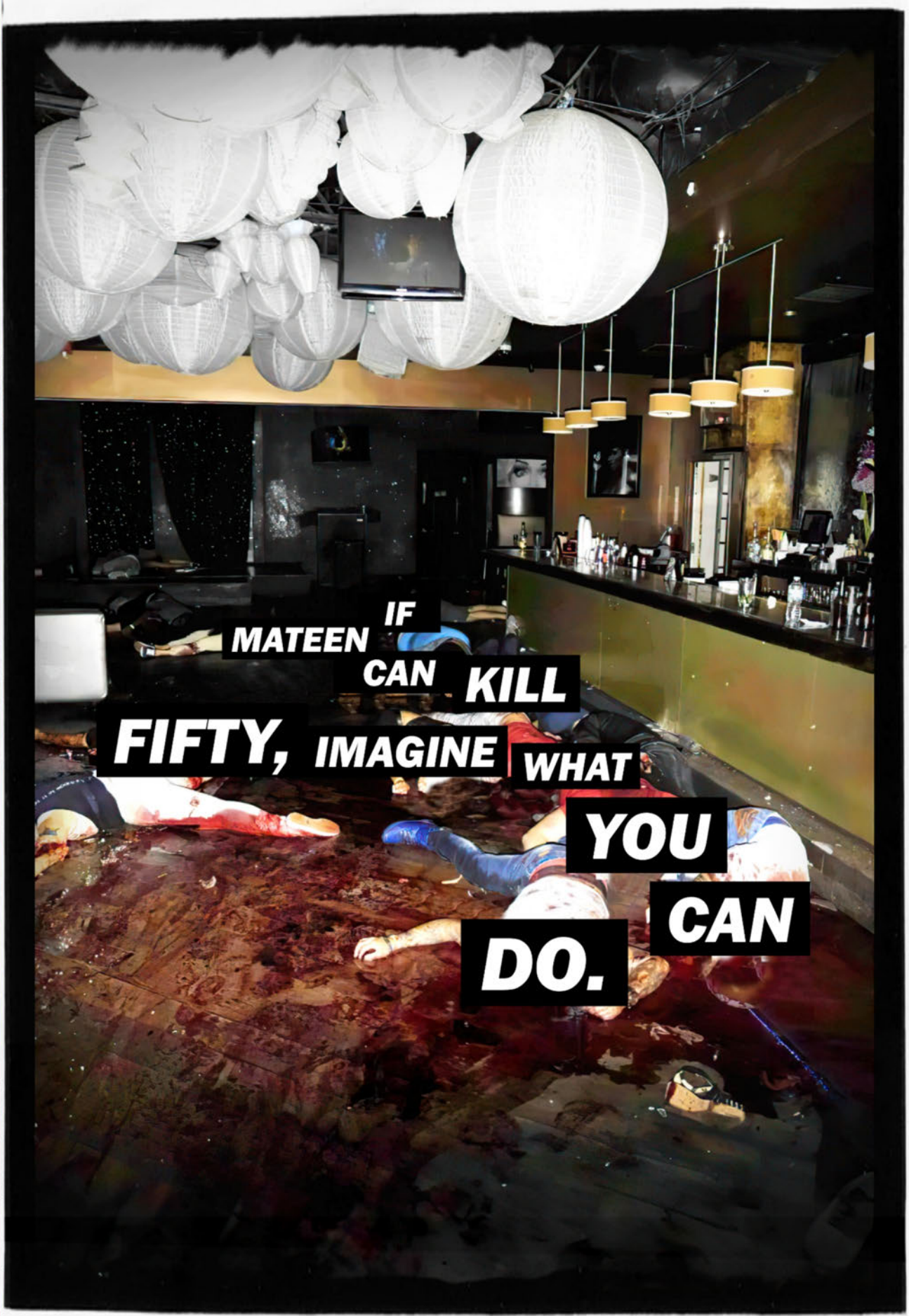

**IF
MATEEN
CAN KILL
FIFTY, IMAGINE WHAT
YOU
CAN
DO.**

THE HARD RESET

Keep the Rot Save the Tools - Yankee

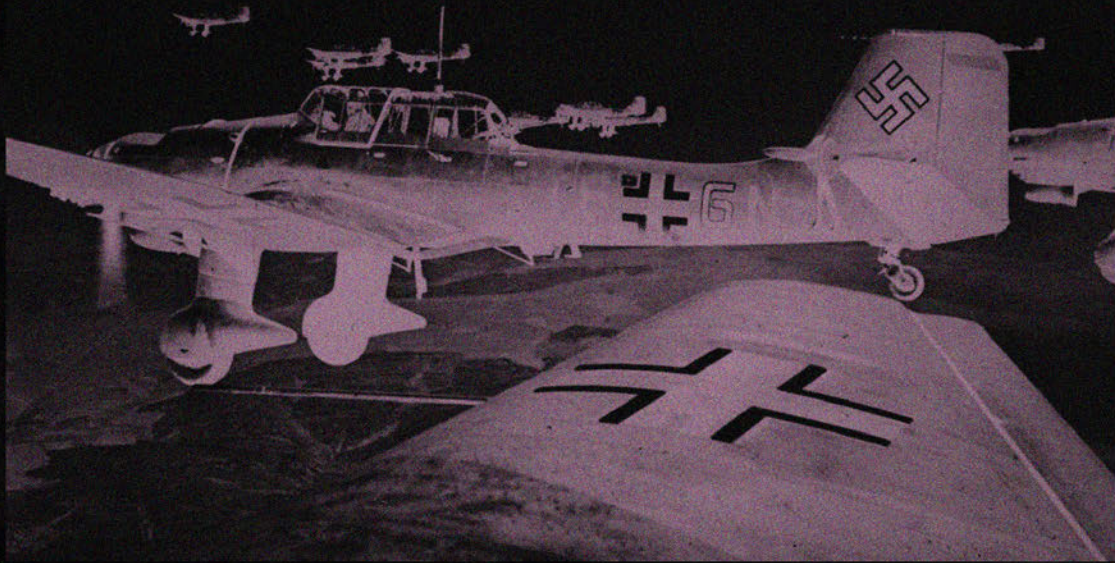

You are the pilot on a flight never booked for you. You have some uncomfortable options: tail spin into oblivion, land in a place where you will never prosper, or make an unscheduled stop in parts unknown. We always have options; choices that we think we don't have. The truth is the world we live in now is less excellent and less coherent than it once was. Delusions have turned into a solvent of present day society leading the future into an unknown chaos from which new orders will be born. Break the flow of what things are. Get Creative. Get Dangerous.

PAGE #194



THE HARD RESET

WASH YOUR HANDS OF THIS FILTH—TANGO

READY TO THINK,
READY TO FIGHT.

CLEAN MIND,
CLEAN BODY.

WHETHER PHYSICAL, OR MENTAL.

PAGE
195

THE HARD RESET BLUNT ROTATION - ZULU



PEOPLE TALKING ABOUT "BLUNT ROTATION".
ONE TIME I WAS DOING THE HELICOPTER WITH A PAIR OF
NUNCHUCKS IN THE AIR UNTIL I CLOBBERED
MYSELF IN THE BACK OF THE HEAD
LIKE A FUCKIN RETARD AND PASSED THE FUCK OUT ON THE CARPET.
I HAVEN'T BEEN THE SAME SINCE
HOW'S THAT FOR BLUNT ROTATION YOU FUCKIN NERD.

THE HARD RESET

"WE'RE IN THIS TOGETHER."

To normies, it's a catchphrase. But for us, it's a mantra and one of the deadliest weapons in our arsenal.

The idea of a decentralized collective of lone actors, physically separated but united by a common struggle, purpose, goal and enemy - the System's greatest fear - the ultimate threat. We're in this together.

If you've committed yourself to Our Cause, we're in this together.

All White men and women of Action, prepared to live, fight, kill and die in the name of Our Struggle, we're in this together.

Accelerationists of today - White Guerrillas of tomorrow - Lone Wolves of the past, present and future - we're in this together.

Loading.....

Page - 197

WE'RE IN THIS TOGETHER
- WHISKEY

ERROR

ERROR



THE HARD RESET

RACE TRAITOR – Oscar

Listen to what our enemies have to say about us every once in a while. The 14 Words are treated as a declaration of war upon the System that cloaks itself in civility when attacked, only to throw it away and openly call for Our People's eradication seconds later. Yet the 14 Words – We must secure the existence of Our People and a future for White children – is simply a declaration of Our Race's will to survive. No 14 Words means no existence of Our People, no future for White children means an entire race's genocide. You'd think those who care so much about the so-called "holocaust" would oppose such a future, and you'd be dead wrong because the Enemy knows that the Struggle is one between us and them. So the 14 Words are not allowed, and White people are only barely accepted in the System so long as they defy their message. Yet even those race traitors who have been fully brainwashed into hating their race are not entirely safe from the System's lashing out. Why? Because "it's not enough to not be racist, you must be actively anti-racist", as say the countless corporate-sponsored diversity training handbooks. All it takes is an off-color joke and even an otherwise good little obedient race traitor finds themselves on the chopping block. To sum up, the 14 Words are racist and racism is inexcusable to such a degree that every White person is expected to fight against it or face the consequences. In other words, every White person is expected to act against the security of Our People and a future for White children.

The only way for you to be seen as anything other than a suspected Nazi is to murder your own people.

HARD RESET UNRELATED POSTS

DIRECT ACTION? IT ACCELERATES BECAUSE IT INCREASES PRESSURE ON WHITES. THE PRESSURE IS A GOOD THING AND PUSHES MORE TO OUR SIDE EVERY DAY WHEN THE LINE IN THE SAND GETS CLOSER AND CLOSER TO THE DOORSTEP OF THE WORKING CLASS WHITE GUY. EACH DAY, THE LINE IN THE SAND LEAVES THE BEACH AND COMES TO THE DOORSTEP OF THE YUPPIE LEMMING TO KISS HIM ON HIS FAT CHEEKS, FORCING EVEN HIM TO MAKE MOVES.

KILL THE AIR CONDITIONER OF THE LEMMING. RAID THE CORPORATE CONSTRUCTION SITE FOR TOOLS. MAKE THEIR LIVES HARD AND MAKE SURE TO COMPLETELY ERODE THEIR TRUST AND LOVE FOR THIS WORLD. CUT PEOPLE OFF IN TRAFFIC WHEN IT DOESN'T EVEN BENEFIT YOU, THEN LAUGH WHEN THEY FUME BY YOU IN ANGER. REMIND PEOPLE LIVING IN THE PAST OF THE TRUTH; THEIR TIME IS OVER AND OURS IS NOW.



199
HOTEL

LOADING MAGS WHILE WRITING THIS. ELECTION DAY 202X. THE PREVIOUS TWO PARAGRAPHS ARE UNRELATED AND HAVE NOTHING TO DO WITH EACH OTHER. IN FACT THEY ARE QUOTES OF TWO SEPARATE PEOPLE THAT ARE NOT EVEN MY OWN WORDS.

—A—C—C—E—L—E—R—A—T—E—
H A R D R E S E T

Ammo shortages and skyrocketing prices have become an agonizing and all too familiar staple in recent years. If these untenable circumstances have led you to start reloading, you've probably seen the effects of supply and demand trickle down, making supplies harder to find (and a lot more expensive).

Boomers will lament this and complain tirelessly to whoever will listen, whilst ordering thousands of rounds with every pension check, and spending every weekend at the range with their buddies - as a hobby.

As an Accelerationist, a White Guerrilla, a mortal enemy of the beast System, you CANNOT afford to adopt this mentality. Even if you could afford to, financially - Our Race cannot.

Start treating brass like the precious metal it is. You can't control the cost of ammo, but you - and only you - determine its value.

You've got one round in the chamber. Will you put it through a paper target at the range, or a high value target where he's most vulnerable? Will it be worth more than its spent shell casing after it's fired? Will it make history by kicking one of the System's crutches out from under it?

That's up to you. You, and only you, have the power to make that decision.

the hard
whiskey

the hard
whiskey

Train regularly, but mindful.
MAKE. EVERY. SHOT. COUNT.



200



THE HARD RESET



AUTHOR: WHISKEY



PAGE: 201



GOAL: TOTAL NIGGER DEATH

THE HARD RESET

MUTUAL COMBAT

THE CORRUPT POLITICIANS RUNNING AMERICA'S NIGGER INFESTED CITIES HAVE MADE A CONCERTED AND CONSCIOUS DECISION TO TURN A BLIND EYE TO MUD-ON-MUD CRIME.

LOOK AT CHICAGO - IF A MURDER IS ASSUMED TO BE GANG RELATED, THE PIGS WON'T EVEN INVESTIGATE, LET ALONE PROSECUTE.

"MUTUAL COMBAT," THEY CALL IT... BECAUSE "EQUITY," OR SOMETHING.

DON'T LAMENT THE SYSTEM'S DOUBLE STANDARDS.

ACCEPT THE INVITATION.

LOAD YOUR MAGAZINES.

ZERO YOUR SCOPE.

TAKE A LITTLE ROAD TRIP, SAINT FRANKLIN STYLE.

OPPORTUNITIES LIKE THIS ARE BUT ONCE-IN-A-LIFETIME.



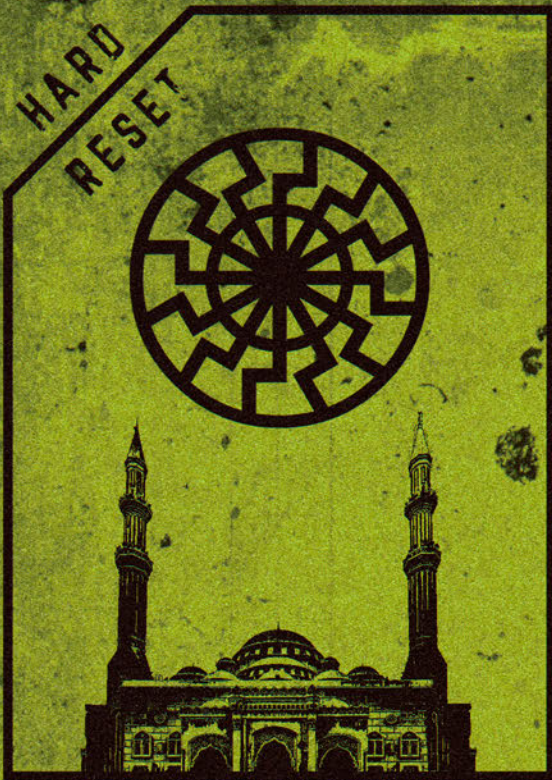

THERE'S ONLY ONE REASON

WHY A WHITE MAN SHOULD SET FOOT INSIDE A...

- SYNAGOGUE
- MOSQUE
- SIKH TEMPLE
- NIGGER CHURCH
- SECULAR CULT



... TO SEND WHITE "CONVERTS" TO HELL WITH THE REST.



TWO WITH BIRDS H

Now I don't know how many of you are well-versed in different forms of dance but I'd like to tell you about one you should definitely know about. It is called "Kizomba" or its offshoot genre "Urban Kiz". I encourage you all to research it after I am done. Kizomba is an African genre of dance originating in the nation of Angola. It translates to "party" in Kimbundu, the Bantu language spoken in the country.

The dance genre can only be performed in couples (a man and a woman) and the music accompanying it is generally hip-hop style instrumentals. The dancers' goal is to "synchronize perfectly as a couple with the music and express it through elegant footwork, smooth body movement and attitude."

Here's the part that is of interest to you, kizomba is gaining popularity in all Western nations. From North America, South America, and all throughout Europe. It is dominated by black men and white women who make up the duo. Now I want to stress that you shouldn't write this off as some trashy nigger twerking ritual. While it is by no means classy, it has a real dance foundation and will become only more reputable with time. And maybe that is what gives it the ability to get so big, because it won't turn off women at a first impression. They have festivals in cities like Budapest, London, Mölndal, Helsinki, Warsaw, Lisbon, and the biggest festival, Kizzafro in Moscow.

You might not know this but there are kizomba clubs in every city, just look it up in the closest city near you. By all means search "kizomba" or "urban kiz" on YouTube or Instagram and you will see a plethora of interracial couples intimately dancing. Really you can think of kizomba as the world tour race-mixing circus where people from all over travel to partake in these special festivals.

And don't be surprised when possibly your daughter's dance teacher wants to incorporate this African culture into their routine.

I think you get the point I am trying to make here. You should just remember that old saying, *I can kill two birds.....*

SO
ONE

BYTANGO

THE

HARD
[203]

RESET

HARD



RESET



TURN IDEAS IN TO ACTION

PULL THE FIRE ALARM

GOLF

What's to stop someone from mailing meme suspicious packages and calling in bomb threats once per week toward Google headquarters or otherwise?

No cost to you, little risk, and you're effectively stifling their operations. Stopping anyone from getting a good work flow started when they need to evacuate the building every time they try to begin a project.

It doesn't even need to be real bombs, they might treat it like it would be, but you're more or less pulling a huge prank and softening the enemy's ability to detect terror. Some day a real bomb will arrive as some faggot media boss opens it frantically in front of his employees to show them how there couldn't be anything spicy inside.

The same applies to any drag queen brainwashing hour they put on for kids at your local library, university, or united church.



Protesting in person?

HIGH RISK, LOW OUTPUT



Calling in a bomb threat?

LOW RISK, HIGH OUTPUT



PULL THE FIRE ALARM
GOLF

THE HARD RESET COUP DE GRACE - Mike

Public utilities are, for most of us, an afterthought. Most of us have never known life without them, so they're taken for granted as "permanent" fixtures of the modern age. That's why the public panics when there's a disruption in service, however brief. And it's why that panic turns to hysteria when they fail catastrophically and cause very UNnatural disasters.

Sabotage attacks on critical infrastructure are rare at this stage. Nevertheless, we're cautiously optimistic whenever there's a massive fire at an electrical substation, a gas leak and subsequent explosion, or a long-lasting blackout.

But when yet another disaster is blamed on "faulty equipment" or "crumbling infrastructure," don't be TOO disappointed.

Those announcements hit different when you're sabotage-pilled.

Utility companies, particularly repeat offenders with multiple man-made disasters under their belt, follow the same predictable formula in response:

1. Preventable disaster occurs
2. Utility company clearly at fault
3. "Internal investigation"
4. Accept liability but shift the blame to the infrastructure/equipment itself, and away from personnel
5. Price hikes (and often tax hikes) to raise revenue for repairs, upgrades and maintenance to "prevent future disasters"
6. Line their pockets, fix nothing
7. Infrastructure continues to crumble
8. Another preventable disaster occurs
9. Repeat steps 1-8

THE HARD RESET COUP DE GRACE - Mike

Crumbling infrastructure becomes an irresistibly convenient cash cow and extortion racket for greedy local and regional monopolies, and the corrupt public officials they're in bed with. Their price hike announcements often accompany a detailed "plan" pinpointing what's in dire need of repair.

Do go on, you filthy, gluttonous pigs. Tell us more about which infrastructure is at the highest risk of failure. Make sure we understand how frail, weak and vulnerable the System's backbone is. Make sure we know exactly where to strike. Make sure we realize how easy it would be to destroy your bread and butter with basic knowledge, tools, weapons and chemicals.

Broadcasting weakness to garner sympathy might win in politics, but it loses wars. This is a lesson they'll have to learn the hard way.

**Don't let infrastructure continue to crumble.
PUT IT OUT OF ITS MISERY.**

THE HARD RESET

For the past 2 years, and especially now - in the wake of Denver and Buffalo - the System views Accelerationism as its most lethal and imminent terror threat. And, for once, they are correct.



W H I S K E Y
IN PLAIN SIGHT
IN PLAIN SIGHT
IN PLAIN SIGHT



207

PAGE



For every Accelerationist that attacks, there are 100 others lying in wait.



For every Accelerationist with an internet presence, there are 1,000 shrouded in untraceable anonymity.



For every Accelerationist who contributed to this book, there are 10,000 others who will download, read and become further radicalized by it.

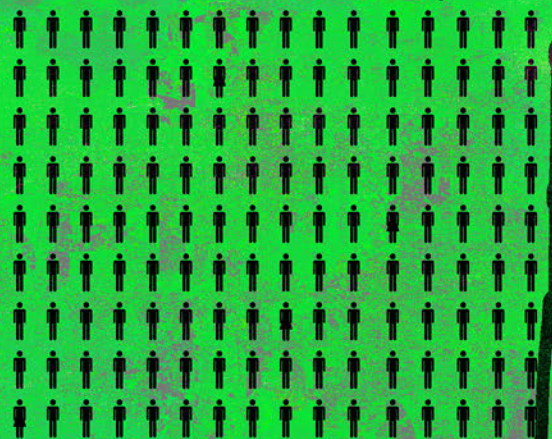

SHOOTING MCCLXXXVIII



THE ACCELERATIONIST THREAT



DRY RUN



SO YOU'VE DECIDED TO ATTACK A LARGE PUBLIC EVENT.

That's great! Let me give you some pro tips, while I can. Have you gone through a dry run yet? It's an important step you definitely don't want to skip. Floorplans, maps and interior pictures are helpful, but they're no substitute for actually BEING THERE. If the venue is open to the public normally, take a trip there anytime. If not (i.e: convention center, sports stadium, auditorium, concert hall, etc.), check their events schedule online and attend at least one of them.

Wear a hidden camera during your walkthrough and canvass as much of the premises as possible. Make note of security and staff presence, checkpoints, entry/exit points, security cameras and their blind spots, hallways and corridors. Are the security guards armed or unarmed? Are there a lot of them? Are there metal detectors? Can these obstacles be bypassed? If so, plan your anticipated route accordingly.

Identify ideal sniper positions, places to open fire at close range, and concealed-but-accessible locations to plant bombs or incendiaries. Which conference rooms or buildings have the highest occupancy? Where do the largest number of soft targets gather? Once you memorize and mentally map out the venue, the programme for the event you plan to attack will make a lot more sense. You might have to buy tickets and register as an attendee to get this information - do so under a fake name of course, and pay with cash or crypto if possible.

Your mentality during the walkthrough is crucial. Pretend like it's your Big Day; really get your head in the game. When you find the perfect place to initiate, go from there. Plan your movements. Make note of potential areas of cover along the way, as well as areas without cover (where you'll be most vulnerable). You might not expect a counter attack, but prepare for one just in case.

Double back and re-canvass the venue again, this time from your targets' POV. If you were being attacked, where would you run? Where would you hide? What escape routes might you take? Would you fight back or try to flee? What furniture or fixtures are present, which could be used against an assailant if you were cornered?

Another thing to consider is your expected attire and weapons concealment. Is it a formal suit and tie event? Business casual? In either case, how many 30rd mags can you carry without catching anyone's attention? Handguns are easy to conceal, but if you plan on using a rifle or submachine gun, you'll have to get creative: consider a duffel bag or briefcase, respectively.

Don't limit yourself to my suggestions here. Every target is unique, so be sure to consider the circumstances, variables and opportunities presented by yours. Get creative, take notes, stay sharp and think outside the box. You should walk away feeling certain, optimistic and confident.



HAVE NO DOUBT: YOU'VE GOT THIS.

// THE HARD RESET // MIKE // PAGE 208 //



NO REGRETS

THE HARD RESET >> WHISKEY >> PAGE 209



TWO WHITE MEN WITH
THE SAME WORLDVIEW ARE
SERVING LIFE SENTENCES IN PRISON:

ONE, A MAN OF ACTION.
THE OTHER, A MAN OF CONTEMPLATION.

THE MAN OF ACTION JOINED THE PANTHEON.
THE MAN OF CONTEMPLATION JOINED A GROUP.

THE MAN OF ACTION MADE HITS.
THE MAN OF CONTEMPLATION MADE A HIT LIST.

THE MAN OF ACTION WILL BE REMEMBERED FOR CENTURIES.

THE MAN OF CONTEMPLATION WILL BE FORGOTTEN
BY THE TIME YOU READ THIS BOOK.

THE MAN OF ACTION WILL SPEND THE REST
OF HIS LIFE NOT REGRETTING WHAT HE DID.

THE MAN OF CONTEMPLATION WILL SPEND THE REST
OF HIS LIFE REGRETTING WHAT HE DIDN'T DO.

THE CHOICE IS CLEAR. ACT, DON'T "CONSPIRE." NO. FUCKING. REGRETS.



INTERROGATION TACTICS

GETTING INTERROGATED BY POLICE?

HERE'S A HANDY LIST OF TRICKS.

1. Pretend it's a game of truth or dare, then dare the cop to shut the fuck up.
2. Only answer questions with other questions.
3. Shit your pants on purpose.
4. Yawn whenever the cop looks at you.
5. Burp the melody of the soviet anthem.
6. Try to "sell" the cop your handcuffs like they're a pen and you're trying to get a promotion at a marketing company.
7. Look away at the two-way mirror/camera like you're in the office.
8. Make monkey noises.
9. Keep switching bad imitation accents.
10. Go on and on about something esoteric that literally nobody but you care's about if all else fails, keep holding your breath until you pass out repeatedly if that fails too, call on your friend Candice.



VICTORY TO THE KLAN HOTEL

The Greensboro Massacre

"Death to the Klan!" On Saturday, November 3, 1979, that chant swept over Morningside Homes, a mostly black housing project in Greensboro, North Carolina, as dozens of protesters—some donning blue hard hats for protection—hammered placards onto signposts and danced in the morning sun.

The American left had largely given up on communism by then, but these demonstrators were full-on Maoists. Their ranks included professionals with degrees from places like Harvard and Duke. And they were descending on Greensboro, a city where sit-ins helped launch the civil rights movement in 1960, to ignite another revolution. They danced to a guitar player singing, "Woke up this morning with my mind set to build the Party." Their children dressed in tan military shirts and red berets. They even brought an effigy of a Klansman, dressed in a white sheet and hood, which kids from the neighborhood joined in punching.

The communists planned to begin their march at noon, moving from the housing project to a local shopping center. But just after 11:20, a caravan filled with real Klansmen and Nazis surprised them, snaking through the neighborhood's narrow byways. As the protesters stood their ground, a man in a white T-shirt leaned out the passenger window of a canary-yellow pickup truck, and yelled,

***"You asked for the Klan. Now
you got 'em!"***

The station wagon behind him carried four Nazis. Seven more vehicles followed, carrying nearly 30 more men, including an Imperial Wizard of the Klan.

What happened next took just 88 seconds, but still reverberates 40 years later. In a confrontation where White supremacists began firing pistols, rifles and shotguns, and with television cameras rolling but police nowhere to be found, five communists were shot dead in broad daylight. Ten others were injured, some left to lie bleeding in the streets.

On the morning of November 3, traitor and informant Eddie Dawson called his Greensboro Police contact to say that three dozen supremacists from around the state, including Virgil Griffin, were assembling at a house owned by one of Dawson's Klan pals, a few miles from the Morningside Homes march site.

A little later, Dawson called again to warn that the place was chock full of firearms. But that information never made its way to the shift commander, who wrapped up a daily briefing at about 10:30 that morning by reminding his men the parade permit listed a start time of noon. The officers could get breakfast, he said, so long as they were on the route by 11:30.

As the Klansmen and Nazis made their way along Interstate 85 into Greensboro, a Greensboro Police detective spotted the caravan and called in to ask if tactical units were in place. His supervisor, showing no special concern, replied that there was still "another fourteen minutes by my watch" for breakfast.

THE HARD RESET

The leftists planned to line up their crew at 11:00, then begin marching at noon. But at 11:22, a frightening transmission came over a CB radio: Klansmen were talking about closing in. Before the protesters could react, cars with Confederate-flag license plates began approaching. There were no cops in sight.

Dawson, who was leading the convoy, would later tell police and reporters that he merely wanted to put a scare into the Maoists before driving on to the spot at the shopping center where the march would end. It was Dawson who yelled, "You asked for the Klan. Now you got 'em!"

But then Griffin's white LTD screeched and swerved, nearly hitting a marcher. The caravan came to a stop. The communists went from singing to swinging, banging their placards on the cars. Members of the convoy poured out, punching through the melee, grabbing weapons. Dawson told his driver to get the hell out of there—and since they were in the first car of the caravan, they were able to split.

The WVO had packed a few weapons, but were seriously outgunned. One of the WVO leaders, a physician named Jim Waller, lunged for a 12-gauge shotgun he'd stashed in a car, but a Klansman flew toward him before he could fire. The two rolled in the grass, fighting nose-to-nose over the weapon until others started piling on top of them and the pump mechanism snapped. Waller screamed as the pump-action crushed the bones in his shooting hand.

Amidst the chaos, other white supremacists lined up their shots. A Nazi named Jack Fowler opened the trunk of a blue Ford Fairlane and, with a cigarette hanging from his mouth, handed out rifles and shotguns. David Matthews, from Griffin's Klan, stood behind the door of a van and nailed his first target, a race traitor named Mike Nathan. Then Matthews took down an organizer and race traitor named Jim Wrenn, who was crawling on his belly. race traitor Bill Sampson, a former Harvard Divinity student, tried to give Wrenn rifle cover but took two fatal shots in the heart.

Roland Wayne Wood observed Waller writhing from his crushed hand. Coolly aiming his shotgun, the Nazi delivered a blast into the physician's right side. Matthews, the Klan member, finished the job with another blast into Waller's back.

The convoy sped away, with Matthews' van the last to leave the scene. Climbing aboard, Matthews let the rest of squad know: "I got three of 'em." Moments later, police intercepted the van, but didn't get to Morningside Homes until the shooting was over.

Eighty-eight seconds of gunfire in Greensboro.

Twenty-six years after the massacre, Virgil Griffin surprised everyone at the Greensboro Communist Truth & Reconciliation Commission by showing up and taking questions.

Asked why no Klansman was killed in the shootings, he answered:

"Maybe God guided the bullets."

HABBESEI

OSCAR

OSCAR

C
O
L
O
N
I
E
S

G
O
Y
F
E
E
D

"What happens in the colonies, stays in the colonies"

I couldn't even find a pic from the Belgian Congo "genocide" but you get what I'm saying.



When's the last time you had organ meat?
"b-but it's icky!"
You've been conditioned to develop the palate of an 11-year-old, to stuff your face with chicken tendies and processed mac & cheese and instant ramen, and to scorn anything that the System doesn't want you to eat because it has great nutritional value - macro AND micro. Coincidence, right?

Pick up a can of cat food and read the ingredients list. Your pets get fed scraps off the food industry's table and they STILL eat better than you do.

By the way, nigger cuisine is just prison food and school lunches.

I will destroy 100%, ensuring that not even 1% of this poison can be used.
Homo chemicals, endocrine disrupting, riddling peoples bodies with cancer.

Soy farmers? Cowards, hiding. I can't wait until their sons grow tits and
start getting blow-banged. The soy farmer deserves that.

Maybe one of us should develop a fungus which targets soy. They will bend at
the knee.

I will walk through their fields, unlocking the mysteries of soy killing
the chickens.

Tradesmen, priests, the youth, they will form as huge crowds to observe me
driving an F350 through the soy farmer's field, dumping salt behind me.
Screaming the nigger-word.

They will know no bounds to their misery. They should have grown cabbage.
Faggots.

I will summon devious patterns of destruction upon their fields.
The fields littered with the corpses of soy. Death, mass graves of torn up
soy.

Soy ripped from reality. To call it soy pestilence will be an understatement.

I guess people will just have to eat real food when I'm done.

ZULU



HARD COPY

THERE IS A WIGNAT AMONG US



LOCAL

ONLINE

HOW TO PLAY

FREEPLAY



THE HARD RESET

THE SHOAH GOY - SIERRA

YEAH, IT MAY NOT HAVE HAPPENED...

BUT WE CAN ALWAYS TRY AGAIN!!

PAGE-216

THAT HINDU KUSH HIT DIFFERENT

Afghans have humiliated the Brits in the 19th century,



the Soviets in the 80s,

THE HARD RESET
2022

OSCAR, PAGE 217

and the Americans in the 2000's.

Who's next?

China, obviously.



They need to secure their grip on Central Asia and Afghanistan will be key to this effort. Taliban stands in the way and China will need to crush any resistance, employing more brutal methods than the Americans would have dared to, thanks to the signature Chinese lack of regard for human life.

They will fail.

Not only because the Chinese military is a child with too many shiny new toys, experience didn't help the Americans much either. It's mainly due to the fact that the Chinese military will have to transport forces and material through mountainous provinces populated by a muslim minority that has been oppressed by the regime in recent years. Taliban will absolutely make use of this and create trouble for China not only abroad, but also on the homefront.

After Xinjiang raises the banner against the capital, other provinces are sure to follow. Tibet has been subject to genocide not unlike the one our people have been subject to, through "peaceful" population transplantation and top-down cultural annihilation, for at least as long as we have. Tibet also controls much of the Chinese water supply. Hong Kong can likewise be expected to rise up when the opportunity presents itself - its population has been spoiled by the fruits of White civilization and sees mainland China as outsiders.

That's not even taking into account the foreign powers, who will no doubt strike while the iron is hot, taking advantage of a weakened regional power, especially in the South China Sea.

The belly of the dragon shall drip BLOOD.

**THE HARD RESET
2022**

OSCAR, PAGE 218





THE

HARD

RESET

ON THE OTHER SIDE - YANKEE

PAGE-219

WE COMMIT OURSELVES TO HELL SO THAT OUR CHILDREN MAY LIVE TO SEE HEAVEN. OUR WISH IS INDEPENDENCE AND STALEMATE SO THAT WE MAY PROSPER IN OUR OWN WAY AND FIND OUR WILL TO ADVANCE AND FURTHER THE ADVANCE OUR PEOPLE AND OUR KNOWLEDGE. I HOLD A FEAR THAT IF THE OLD CONFLICT OF YESTERYEAR IS RESTART WITH OUR SOLE PURPOSE FOR FIGHTING BEING FOR REVENGE: THAT WE MAY NEVER COME HOME FROM SUCH A CONFLICT. THERE MUST BE SOMETHING AFTERWARD WE HAVE TO LOOK FORWARD TO. OTHERWISE YOU ARE FIGHTING A HOPELESS CONFLICT. THE BE ALL END ALL OF LIFE IS NOT DEATH NOR TIME BUT THE FEAR OF DEATH AND THE RESOLVE OF OUR ENEMIES WHO SEEK THE DESTROY ALL WE HOLD DEAR. THE LOST LESSON OF THIS IDEOLOGY IS DETERRENCE. CAN WE BE A PROPER EMPIRE THAT CAN EXIST LONG ENOUGH TO A WORLD POWER? CAN WE BECOME UNFORGOTTEN THROUGH THE HALLS OF HISTORY? CAN WE AVENGE THE LOST SPIRITS OF WARRIORS LONG GONE? MEN WHO DIED IN VAIN FIGHTING TO THE BITTER END. CAN WE SHOW THEM LONGEVITY IN GLORY? OUR TIME IS CREEPING NEAR. THE PETTY AND GREEDY AWKWARDLY EXPOSE THEMSELVES IN THEIR EVIL. THERE MAY COME A TIME WHERE YOU DON'T HAVE A CHOICE AND ALL YOU HAVE IS CHOICES.

IT IS IMPOSSIBLE TO FIND HAPPINESS, PEACE, OR PROSPERITY THROUGH THE DOMINANT POLITICAL SYSTEMS OF TODAY. THEY WILL NEVER RELINQUISH CONTROL TO YOU WITHOUT A REAL THREAT OF LOSING ALL AND EVERYTHING. TIME HAS MADE THEM FORGET THE LESSONS OF HISTORY. THINGS NEVER STAY THE SAME. NEVER SHOULD WE BECOME COMPLACENT LIKE OUR ENEMIES. NEVER SHOULD WE LET HISTORY BE LOST ON US. NEVER SHOULD WE LET THE SYSTEM CONTROL WHAT WE THINK OR DO. WE ARE REBELS AND MISFITS OF A TIME NOW FADING. BUT THAT DOESN'T MEAN WE SHOULD FORGET.

**T
H
E

H
A
R
D

R
E
S
E
T**



FUCK INDIANS

Convince an indian to do a terror attack to kill 20 more.

Other indians would see the attack happen, and just throw the bodies in to their 'holy river ganges' to rot

THE STATE OF INDIA IS ONE OF A GIANT GANGRENE WOUND ON THE EARTH

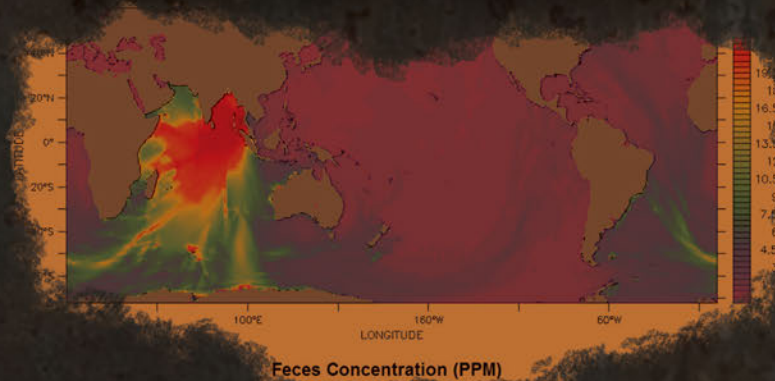

The kind of things you would find in their holy river in even a square meter would include but not be limited to:

- **Bodies**
- **Garbage**
- **Feces/Piss**
- **Industrial Run-off**
- **Plastic**
- **Heavy metals**
- **Commercial building discharge**



Source: I really hate indians



**HARD
RE
SET**

page
222
page page

**FUCK
BA
NKS**

HOTEL



i like to keep nothing in my account

throw a few pennies in for car insurance or whatever else

the banks use your money to invest in companies where they gain seats and more or less vote against you on your behalf

sometimes i fly a little too close to the sun, leave too little in my account, and get hit with a \$5 overdraft fee, but it's nothing considering the damage banks really do when you choose to leave a lot of money with them

keep your cash on hand, make some rare normie-tier purchases like groceries, and lock them out of your life.

A TASTE OF TERROR

GOLF

"Cowardice is a trait wherein excessive fear prevents an individual from taking a risk or facing danger. It is the opposite of courage. As a label, "cowardice" indicates a failure of character in the face of a challenge. One who succumbs to cowardice is known as a coward."



The days approach where every person who has spoken fanatically online, or even just to their friends in private will be forced in to action. The system knows who you are and has only chosen not to act yet.



The system will have no problems walking up to you, and figuratively punching you right in your mouth. When you're down, the system will deliver soccer kick after soccer kick to your head and neck until it no longer wishes to do so.



The system will do the kind of thing that really leaves not the taste of blood, but leaves the taste of Terror in your mouth.



Perhaps the time is coming press the system and let them know what it is to be hunted, what it is to taste terror.

NOT FOR MONEY - NOT FOR ATTENTION - NOT FOR FUN

HARD RESET



We are a nation of cowards who are perfectly capable of observation, but are unwilling to risk our own security to change things. Patriots used to have a grasp of what America is supposed to look like but many now are misguided and totally encapsulated by illusions. You are not safe, you can't be happy like this, you can beat your enemy, it can't be done while being nice.

The Government pursues hedonistic delusions, claiming certainty of that goal bringing about virtues and prosperity. In reality, they sell a peace without escape or freedom.



By all means fighting for your own interests is a law of survival. Fighting for your friends and family is a fight for your future. Fighting for your culture and people is the law of prosperity.

No war is won without purpose.

A terrible lie has been told about American culture. From the late 2000's into the 2010's a wave of unjustified, uncultured prosperity began without any sense of realism or honesty. This high point for pleasure and low point for culture was leprosy to the nation. Expression without any real hesitation or struggle isn't art. Neither is an army of ghost writers making your music anything but a pure act of greed.

The lie of the multicultural nation is equal cultural representation. America follows only two things: comfortably and money. By choosing this, much of America's cultural interests have unwillingly been removed from the greater conscious. It is difficult for this to not be compared to removing all spices or vegetables from food. A cultural underclass is now boiling in repression. Just like the rest of this nation they are forced into conformity. Sincerity can be easy too fake by those who live only in pursuit of money. Actually everything can be faked when greed is your only real interest.

A real person must find purpose in a feckless impotent world where nuance and sincerity are met with apathy. One must become a center of clarity and purpose.



THE HARD RESET

IMAGINE - KILO

IMAGINE THE HAVOC YOU COULD WREAK WITH THE AMMO SUPPLY OF A NIGGER DRUG DEALER YOU VENTILATED. IMAGINE HOW MUCH MONEY YOU COULD SAVE IF YOU FILLED UP YOUR GAS TANK EXCLUSIVELY FROM PAJEET GAS STATIONS AFTER BEATING UP THE CASHIER AND ACTIVATING THE PUMP FROM THE REGISTER (DON'T FORGET TO FILL UP 5 OR 10 GAS CANS FOR LATER ANTICS).

IMAGINE HOW GOOD YOU COULD EAT IF YOU USED THE ONION TRICK ON A CART FULL OF PRIME STEAKS AT WALMART DURING PEAK HOURS. IMAGINE HOW NICE OF CLOTHES YOU COULD HAVE IF YOU SUITED UP IN BLACK BLOC AND LOOTED STORES ALONGSIDE THE NIGGERS WHEN THEY CHIMP OUT. IMAGINE HOW FUNNY IT WOULD BE IF YOU SLUNG GRAVEL WITH A SLINGSHOT OR TENNIS RACKET INTO A PREDOMINATELY JEWISH NEIGHBORHOOD AT NIGHT. IMAGINE THE FEELING OF POWER AND ACCOMPLISHMENT YOU WOULD HAVE IF YOU SWISS CHEESED A SYSTEM PIG OR AGENT OF ZOG DURING THEIR MORNING COMMUTE OR AT THEIR HOME.

IMAGINE HOW SIMPLE IT WOULD BE TO JUST TAKE THE FIRST STEP INTO A LIFE OF CRIME AND GET AWAY WITH IT. IMAGINE HOW DUMB YOU WILL FEEL UPON REALIZING YOU SHOULD HAVE BEGUN YEARS AGO.

I DISAVOW.

THE HARD RESET

THE ETERNAL VILLAGER - Oscar

GAMERS!

Have you noticed how THE ETERNAL VILLAGER is the bane of every honest miner out there?

Let's go down the list, shall we?

- lives in secluded villages
- has a big nose [in red]
- offers awful prices, both buying and selling
- holds grudges
- is protected by golems without wills of their own
- relies on soft power, completely helpless in a fight [in red]

illustrated by this masterpiece, 6 gorillion hours in ms paint

ADL

okay, Goyim pass the shekels.

FORCE HARD RESET

OSCAR

PAGE 229



FORCE = MASS X ACCELERATION

EAT EGGS, MEAT, AND DAIRY

SEIZE POWER

THIS IS A THREAT

NOLA

“WAY DOWN AROUND VICKSBURG
AROUND LOUISIANA WAY
LIVED A CAJUN LADY
ABOARD THE MISSISSIPPI QUEEN”

THE BOAT'S PRICE WAS WELL-REFLECTED IN ITS AUDIO SYSTEM, ITS SOUND QUALITY BEING ON PAR WITH THOSE BIG RIGID PLASTIC EARBUDS THAT YOU HAD TO CRAM IN YOUR EAR AND IT'D HURT LIKE A MOTHERFUCKER FOR HOURS AFTERWARDS. STILL, DAD ROCK CLASSICS WILL PUT YOU IN A CERTAIN FRAME OF MIND, NO MATTER WHAT YOU PLAY THEM ON. SEASPRAY AND FAMILIAR MUSIC ARE A PERFECT SUMMER COMBO - THAT, AND THE 3D-PRINTED GLOCK IN A ZIPLOCK BAG SQUEEZED INTO THE RUBBER SEAM OF MY SWIMMING SHORTS. THE SUN IS BAKING ME THROUGH THE WINDSHIELD, MADE WORSE BY THE FACT THAT I'M NOT WEARING SUNSCREEN. IN MY DEFENSE, SUNSCREEN MAKES YOU GAY.

I BOUGHT THE BOAT SOMEWHERE IN WESTERN FLORIDA OFF A BOOMER WHO'S CLEARLY HAD ENOUGH FUN WITH IT BACK IN HIS DAY. IT WAS IN SOMEWHAT DECENT CONDITION, JUST REALLY OLD, AND ITS OWNER HAD NO USE FOR IT ANYMORE, SO HE SOLD IT TO ME FOR A PENNY. I WASN'T VERY THOROUGH WHILE INSPECTING IT - I ONLY NEEDED IT FOR ONE VOYAGE.

A FEW OF MY BOYS HELPED ME LOAD THE CARGO OFF A MAKESHIFT BARGE IN A HIDDEN COASTAL SWAMP - A FEW HUNDRED POUNDS OF VARIOUS HIGH EXPLOSIVES. NOW I'M ON MY WAY NORTH-WEST TO THE GREAT PORT CITY OF NEW ORLEANS.

THE LOUISIANA PURCHASE WAS ONE OF THE BEST BUSINESS DEALS IN HISTORY, IF NOT THE BEST. THE MOST IMPORTANT WATERWAY ON THE AMERICAN CONTINENT BOUGHT FOR CHUMP CHANGE, ALONG WITH THE CITY BUILT WHERE THE RIVER MEETS THE SEA, FANTASTIC FOR CONTROLLING TRADE BETWEEN OVERSEAS COUNTRIES AND THE AMERICAN AGRICULTURAL HEARTLAND.

LOOKING AT MY GPS, I CURSE MYSELF FOR NOT TRYING TO FIND A BOAT SOMEWHERE CLOSER ON THE GULF COAST. I FIGURED I WOULDN'T HAVE LIKED TO HAVE TO DOUBLE BACK TO GET TO THE CARGO, BUT NOW I'M STUCK WITH THE CONSEQUENCES OF MY CHOICE. AT LEAST THE FEDS ARE LESS LIKELY TO FIND THE POOR BASTARD WHO SOLD ME THE BOAT THIS WAY, EVEN IF IT MEANS I HAVE TO CROSS HALF OF THE GULF OF MEXICO.

WHEN I GET TO MY DESTINATION, I'M GOING TO WAIT FOR NIGHTTIME AND LEAVE THE BOAT SOMEWHERE ROUGHLY AT THE PORT'S ENTRANCE, THEN SWIM LIKE HELL, PREFERABLY BEFORE ANYONE HAS THE CHANCE TO INVESTIGATE THE MYSTERIOUS OBSTRUCTION. ONCE A MAJOR CONTAINER VESSEL GETS NEAR ENOUGH, I'LL HIT THE SWITCH ON THE WIRELESS DETONATOR, THEN WATCH THE FIREWORKS. THE EXPLOSION SHOULD BE ENOUGH TO AT LEAST TAKE THE SHIP OUT OF COMMISSION FOR A WHILE, IF IT DOESN'T SINK IT OUTRIGHT. FURTHERMORE, THE PORT WILL PROBABLY HAVE TO BE PUT UNDER SECURITY LOCKDOWN AS THE PRIMARY CONCERN IS GOING TO BE PREVENTING ANY DANGEROUS MATERIALS STORED ON SITE FROM EXPLODING AS WELL, A LA BEIRUT. THEN COMES THE BLAME GAME, THOROUGH INSPECTIONS LEADING TO FIRING OF WORKERS WHO JUST WANT TO EARN ENOUGH MONEY TO PUT FOOD ON THE TABLE, MAYBE EVEN LAWSUITS AS THE SYSTEM TRIES TO LOCATE THE CULPRIT. UNBEKNOWNST TO THEM, THE CULPRIT IS GOING TO BE DRINKING MOONSHINE IN A COMPOUND SOMEWHERE IN TEXAS BY THE TIME THEY EVEN GET TO ASSESS THE DAMAGE, ALREADY PLANNING HIS NEXT MOVE.

DEMOCRATIC SOLUTIONS

Adolf Hitler was elected 90 years ago in a >99% White country, and even then, he didn't win the majority until the support came rolling in when he began to show results.



NSDAP VICTORY IN GERMANY FEDERAL ELECTIONS WITH ONLY 43,9% OF VOTES

1933



REPUBLICAN PARTY VICTORY IN US PRESIDENTIAL ELECTIONS WITH 46,1% OF VOTES (ZOG CANDIDATE)

2016

If democrat White nationalists have their way, 90 years from now, White refugees wearing tattered rags huddled around a fire in a cave in the Appalachians will be trying to keep each other's spirits up by pointing out that 90 years ago, Donald Trump was elected.



THERE IS NO POLITICAL SOLUTION

PRESENT AND ONWARDS

SHUT THE FUCK UP!

HARD RESET



DEPORTATION

Deportation isn't just politically unattainable (more so with each passing year as more beaners flood in across the border), it's impractical and unrealistic.

Try cramming wetbacks into buses headed south and see where that gets you - in the court of public opinion AND on the ground, when they start getting uppity.

The ideal form of repatriation is getting the alien populations on board. How? The secret ingredient is terror.



Imagine, if you will, a Crusius-style attack on a beaner establishment every week. A sniper shooting every day, slowly taking its toll. Invader farmhands getting woken up at 2AM by small bands of hooligans setting off firecrackers near their shacks. Shop windows broken, tires slashed, Spanish translations crossed out.



Inflict this upon any population and you'll see the flood slow down to a trickle, then stop completely. Smart money will go back to Mexico while they can.

At this point, if you commandeer enough buses, trucks, vans, anything to carry them back over the border, you can make leaving easier for them than staying. Much easier, quicker and cleaner than killing them all - though there'll still have to be plenty of that up front before this is feasible.

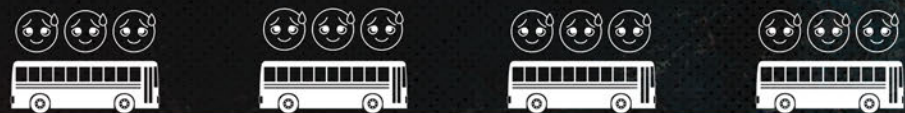

BORDER

NOT OF THIS WORLD OSCAR

Doing things differently from the System's plan makes you detached from The World, this cesspool of degeneracy we're trying to stay afloat in. Eating properly and exercising is one thing, cutting out plastics another, but you need to scratch past the surface to get to the real deal, the kind of activity that confuses the NPCs around you.

Living off the grid, cutting cereals from your diet, being a serious believer in God with all that entails, all of these things will intimidate the sheep in your presence. They will talk about you behind your back in hushed voices, honestly kind of scared of you, trying to "figure you out" even if you're being completely open about your lifestyle and your reasons for doing things differently.

Nothing severs the connection between You and The World quite like forgoing masturbation and pornography. There's a reason most civilizations throughout history have shunned fruitless ejaculation, some (including ours) went as far as to prohibit people from entertaining thoughts of lust. In today's day and age, where anything goes, especially in sexual terms, only the golden standard - celibacy until marriage and sex for the purpose of procreation - is seen by most as something abnormal. Mention to the normalfags that not only do you disdain promiscuity, but also masturbation, and you will surely be seen as "that weird guy" who doesn't fit in. Good.

There are lab coats that claim that abstaining from masturbation for extended periods of time makes you more prone to contracting prostate cancer. Our response is that those that like listening to medical experts with college degrees all of the time can just be escorted to an insane asylum, where they belong.



Imagine being the **retard** who gets blown up along with the **traitors** because you attend political **meetings.**

1 It's a bomb

2 It's my bomb

HARD
POLITICAL
MEETINGS
234
RESET

COULDN'T BE ME
OSCAR



HARD RESET

YOU GOOD?
YOU GOOD?
HOTEL

WHERE ARE YOU AT?

I DONT CARE ACTUALLY, JUST MAKE THE COUNTER EXTREMISM PROJECT'S EXTREMIST GROUPS PAGE LOOK LIKE YOU'RE PICKING YOUR CLASS IN A VIDEOGAME.

**COUNTER
EXTREMISM
PROJECT**

[About](#) [News & Media](#) [Research](#) [Campaigns](#) [Take Action](#) [Global Youth Summit](#)

Stay Updated

Join

Extremist Groups

The Counter Extremism Project maintains a database of information about extremist groups, including their leaders, history, financing, violent activities, government designations, and rhetoric.



Russian Imperial Movement (RIM)

The Russian Imperial Movement (RIM) is a neo-Nazi, monarchist, white supremacist group operating out of Russia with supporters around the world.



Nordic Resistance Movement (NRM)

The Nordic Resistance Movement is a transnational, neo-Nazi organization with official chapters operating in Sweden, Finland, and Norway. The group has carried out violence targeting gay people, ideological opponents and, more recently, Muslim refugees.



YOU

Alone you are the greatest threat. Alone you are at the least risk. Alone or with a few close comrades is the path you should seek.

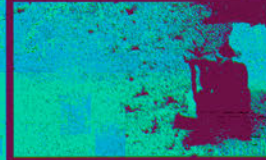

Hamas

Hamas is a U.S.-designated terrorist organization which has killed hundreds of Israeli citizens, as well as Americans in suicide bombings and other terrorist attacks. Hamas has governed the Gaza Strip since it violently expelled the Palestinian Authority in 2007.



Hezbollah

Hezbollah is an Iranian-sponsored, internationally sanctioned terrorist group with an anti-Israel and anti-U.S. agenda. Hezbollah is primarily based in Lebanon, but has carried out terrorist and criminal operations around the world.

JOGGERPOST

THE HARD RESET OSCAR



Acceleration feels good, in all its forms. Stepping on the gas pedal feels good, as does finding out which one of your friends can yell the nigger word the loudest in a public space. Aggravation is acceleration, being a complete and utter nuisance is being a credit to your race. The people must be upset in the proper sense of the word, in order for real change to be affected. Where was I going with this? Anyway...

THE HARD RESET

It's another night out and I have a group of Middle Eastern-looking females in my sights. Their heads are wrapped in rags, but there's no male family members present. Rookie mistake, liberalism has gotten to these ones, making them believe they're less likely to become a target of the White menace if they don't scare the vast legions of White normies. How sorely wrong they are.

Five minutes and a couple glances around the shoulder later, they've started staircasing. I don't even pretend to get off their trail. They start murmuring among themselves in some dunespeak gibberish, glancing back at me in ever shorter intervals. They begin to up their tempo, which I effortlessly match, thanks to a lifetime of playing team sports. Or was it watching them from the sidelines and booing whenever a black player got ahold of the ball? I'm not sure. The distance between them and I decreases. They've noticed.

Screaming, they break into a run and I do the same. I skip the leisurely jog phase and cut straight to the chase. My entire body feels like I've slammed on the gas, even though I'm on foot. My being is pressed to the back of my body, my face is hit by wind, even time seems to slow down, making way for me. I'm fast as fuck, boy. My animal brain rejoices - tonight is hunting time.

I power past my prey without giving it a second glance. I've violated no law, nor interacted with them in any way, there's nothing anyone can do against me other than think mean things about me. It's not illegal to jog without looking like a faggot, so my targets give my back a hateful stare and try to regain their composure.

Once their illusion of safety returns, they will proceed to take out their anger on their White friends and acquaintances, sowing seeds of racial conflict in their own circles at no expense to you. They may even make a public statement about the dangers of being a 2/10 brown female invader. It will go viral, get recommended to an ordinary White guy, who will groan at another piece of propaganda in his entertainment which was supposed to be mindless and apolitical. He leaves a mean comment, gets banned, and deletes the app. One step closer to becoming one of us.

**NORMALIZE
GANGSTALKING
ARABIC FEMALES.**

**OSCAR
JOGGER POST, 237**

DECLARATION VI

THE RAIN ON THE COAST SETTLES, A MOMENT TO CONTEMPLATE;
YOU FIND GENOCIDE, SOFT OR HARD, TO BE THE SOLUTION TO MOST MATTERS

I
PRESENT
I

007-045

II
FUTURE
II

046-084

III
IMPERFECT
III

085-121

IV
PERFECT
IV

122-176

V
FUTURE PERFECT
V

177-237

VI
PLUPERFECT
VI

238-253

HARD RESET



DECLARATION VI INFORMATION

BRAVO - 1 PASSAGE
ECHO - 1 PASSAGE
GOLF - 2 PASSAGES
HOTEL - 2 PASSAGES
JULIET - 1 PASSAGE
PAPA - 1 PASSAGE
ROMEO - 1 PASSAGE
WHISKEY - 1 PASSAGE
TOTAL - 10 PASSAGES
16 PAGES

007 046 085 122 177 238

THE-HARD-RESET REAL-CHANGE-ROMEO

PAGE
239

REAL CHANGE IS NOT MADE
BY VOTING AND NICE
THOUGHTS REAL CHANGE IS
MADE BY...
BRINGING YOUR ENEMIES TO
BUILDING TOPS, BEATING
THEM ON THE HEAD WITH A
HAMMER, THEN THROWING
THEIR RETARDED BODIES
TOWARD THE EARTH.



REAL-CHANGE-ROMEO



THE-HARD-RESET



**....FROM BANGING ON THE DOORS OF ANY LOCAL POPULAR
OPPSITON HANGOUTS, THEN OPENING FIRE ON ANYONE ANSWERING
THE DOOR.**

PAGE 240



REAL

CHANGE

ROMEO

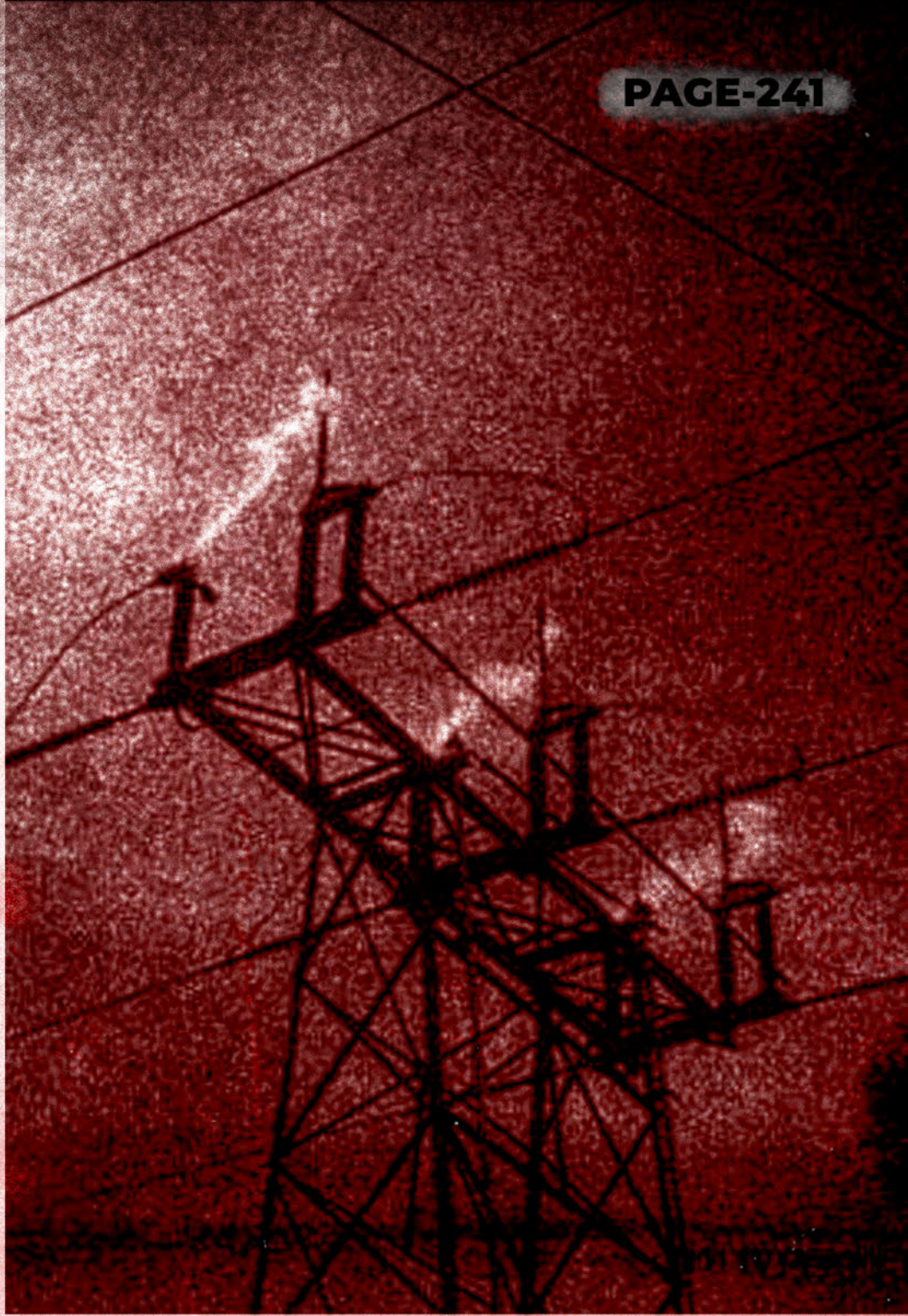

**....FROM CUTTING CELL TOWERS
DOWN THEN USING THE
COMMUNICATIONS DARKNESS TO
IMPOSE YOUR WORLDVIEW ON
OTHERS.**



...FROM KNOWING THAT WHILE BURNING DOWN A BUILDING,

YOU WANT MULTIPLE POINTS OF HIGH HEAT, STARTING IN

LOW POINTS OF THE STRUCTURE.

PAGE 242

///REAL CHANGE - ROMEO///



THE HARD RESET

REAL CHANGE-ROMEO

**...KNOWING A FIREWORKS SHOW IS MORE
THAN ENOUGH NOISE TO BLEND THE SOUND OF YOUR WEAPON.**

PAGE-243

BORDER CRISIS

HOW MANY ILLEGAL BORDER CROSSINGS WERE THERE JUST LAST MONTH? AND THAT'S JUST THE NUMBER THE SYSTEM ALLEGES. THAT'S JUST THE NUMBER OF INVADERS CBP INTERCEPTED.



IF YOU LIVE IN ONE OF THESE BORDER TOWNS, YOU'VE EXPERIENCED THIS FIRSTHAND. YOU CALL BORDER PATROL WHEN BANDS OF INVADERS TRESPASS ON YOUR LAND - THEY DO NOTHING. IF THEY APPREHEND THEM, THEY MIGHT BE REMOVED FROM YOUR PROPERTY BUT THEY'LL BE HOUSED, FED AND RELOCATED AT YOUR EXPENSE. UNDER THE CURRENT SYSTEM, THERE'S ONLY ONE TYPE OF DEPORTATION THAT WORKS - PERMANENT DEPORTATION. SEND THE FILTHY, LAWLESS SPICS BACK TO HELL WHERE THEY FUCKING BELONG.



"UNDOCUMENTED" INVADERS ARE ALREADY NON-PERSONS - THEY HAVE NO IDENTIFICATION. NO ONE KNOWS THEY'RE HERE AND THEY WON'T BE MISSED. COULD GETTING AWAY WITH MURDER BE ANY EASIER?

FROM NOW ON, WHEN YOU CATCH WETBACKS ON YOUR PROPERTY, DON'T GRAB YOUR PHONE - GRAB YOUR RIFLE. OPEN FIRE INDISCRIMINATELY. ERADICATE THEM ALL - MEN, PREGNANT WOMEN, UNACCOMPANIED MINORS, ENTIRE FAMILIES, AND OF COURSE THE HUMAN TRAFFICKERS SMUGGLING THEM IN. BECOME THE FINAL SOLUTION TO OUR BORDER CRISIS, ONE DEAD SPIC AT A TIME.

WRITTEN BY:
WHISKEY

PAGE:
244

IN THE BOOK:
THE HARD RESET

AAAAAAAAAAAAAAAAAAAA



The ideas in this book are more than justified considering what the enemy has already done to our people.

To quote Militant Accelerationism: "THE ENDS MORE THAN JUSTIFY THE MEANS"



AUTHOR: GOLF
PAGE: 245



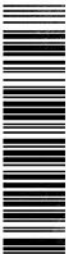

KALOKAGATHIA THE HOSTILE, HOTEL

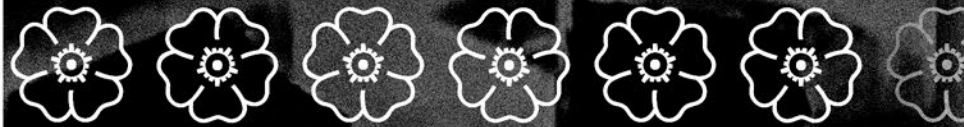

A BOOK FOR MEN
OF THE FUTURE
10934098234098
DEAD YIDS



**AN UNHEALTHY MIND CANNOT
THINK, AN UNHEALTHY BODY
CANNOT FIGHT**

**WE ARE MADE UNHEALTHY AS
A WAY TO INCREASE OUR
DEPENDENCE ON THE SYSTEM
AS A WHOLE**

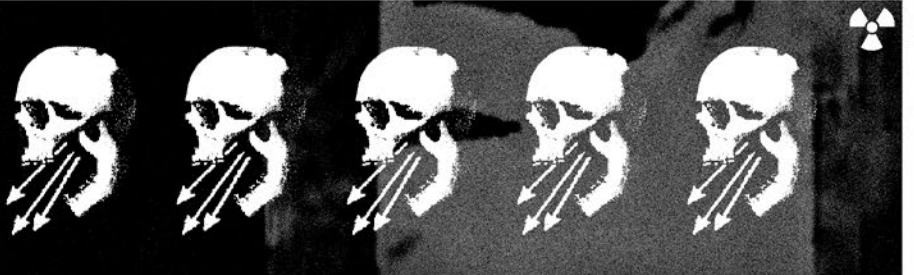

MIND

Netflix makes another series, or revives an old one. it's new interracial homo cast dominates the empty conversations of the jobsite and the office respectively.

A whole generation of under developed teenagers pulling and flicking at their own genitals understand the same memes about the same rotten porn scenes pushed on them - they've seen them all. they've been seeing all of them since they were kids.

Desire to grow, create, do more, utilize, and procreate all set aside until age 30 so the men can do all of this on a screen. so their character can have the life they themselves would have worked toward. so women can rack up a diseasing body count, eclipsing those of any whore who came before them.

Never ending labor to purchase things not needed, but wanted. the desire is unending, the void too big, they back-fill it with corporate bobble heads and a screen to watch, agape.

BODY

Slops of useless grains, devoid of any nutrition are fried in hydrogenated fats and sold to the worst of us as the best food available.

Corn is turned to saccharine syrup and sold at prices so low, the cattle minded individual believe he is always getting a deal, always getting it cheaper than last time.

Huge fields of anti-nutrient rich soy are dehulled to generate all varieties of food additive poison for consumption; fed to cattle and humans who may as well be cattle themselves.

Drug in every available form. cigarette, coffee, joint, powder, pill, and crystal. something for every polluted member of every polluted class, and something for every polluted time of day. Most can be shipped legally to one's front door in record time.

Two paths for the individual:

-eternal dependance on state, media, pornography, game, void, grain, sugar, soy, and drug

CREATION

OR

-complete refusal, and with it, complete freedom. to become the thinker and fighter against this modern world.



A HEALTHY GUT MEANS YOU CAN STAND ON THE SUN WHEN THE TIME COMES



HOSTILE, ADVERSE, HATEFUL, UNWELCOMING, RESOURCEFUL, WARLIKE, MARTIAL, HEALTHY, READY.

HARD RESET

YEAH, I LIVE IN NEW YORK, COME FIND ME 10502, NIGGER



page 246

A LETTER TO THE NEXT DISCIPLES

SAINT TARRANT'S NEXT DISCIPLES ARE OUT THERE SOMEWHERE, AND I HOPE THEY'RE READING THIS. IF YOU'RE ONE OF THEM AND YOU'RE READING THIS NOW, THIS LETTER IS FOR YOU.

YOU HAVEN'T ATTACKED YET, YOU'RE STILL PLANNING, PREPARING AND TRAINING, BUT THANK YOU IN ADVANCE FOR YOUR INCREDIBLE SACRIFICE.

BELIEVE IN YOURSELF AND KNOW THAT WE BELIEVE IN YOU. WE'RE ROOTING FOR YOU, WE WANT YOU TO SUCCEED. HAVE FAITH IN GOD, THE BOSS, YOUR PREDECESSORS, YOUR FUTURE DISCIPLES, AND US - YOUR MANY SUPPORTERS ACROSS THE WEST.

IF YOU'RE CURRENTLY WORKING ON YOUR MANIFESTO, MAKE IT PERSONAL. EXPLAINING YOUR WORLDVIEW, POLITICAL BELIEFS, MOTIVE, GOALS AND TARGET SELECTION ARE STANDARD PROTOCOL, BUT TAKE IT A STEP FURTHER. SHARE YOUR LIFE, BACKGROUND, HOBBIES AND PASSIONS. SHARE YOUR RADICALIZATION STORY WITH US. LET US GET TO KNOW AND ADMIRE YOU ON A PERSONAL LEVEL. ENABLE US TO CELEBRATE YOUR ATTACK, AS WELL AS THE INCREDIBLE YOUNG MAN WHO CARRIED IT OUT. OH, AND PLEASE INCLUDE LOTS OF ICONIC SELFIES WE CAN USE TO MAKE OC - WE'LL BE MAKING EDITS AND TRIBUTES TO YOU FOR YEARS TO COME, AFTER ALL.

IF YOU CHOOSE TO LIVESTREAM YOUR ATTACK, THANK YOU. WE WON'T LET YOUR GLORIOUS DEED BE ERASED. WE WILL ARCHIVE AND IMMORTALIZE IT FOREVER. WE WILL SHARE IT EVERYWHERE, SO THAT IT CONTINUES TO SERVE ITS INTENDED PURPOSE - MOTIVATING AND INSPIRING WHITE MEN TO FOLLOW IN YOUR FOOTSTEPS.

DON'T LET THE DERADS, DISAVOWERS OR CONSPIRACY FAGS MAKE YOU SECOND GUESS YOURSELF, INFLUENCE YOUR DECISIONS OR STOP YOU FROM TAKING ACTION. AS YOU'VE SEEN OVER THIS PAST MONTH, THEY'LL FIND AN EXCUSE TO DISAVOW ANYONE. BUT AS YOU'VE ALSO SEEN OVER THIS PAST MONTH, ALL OF US TRUE ACCELERATIONISTS WILL FIGHT FOR YOU, CELEBRATE YOU, DEFEND YOUR HONOR AND MERCILESSLY BTFO YOUR DETRACTORS. AND WE WILL PREVAIL.

FOLLOW YOUR HEART. YOUR HIGHER CALLING IS YOURS ALONE. YOU KNOW THE ENEMY YOU'RE DESTINED TO FACE, THE TARGETS YOU'RE DESTINED TO KILL, THE WEAPONS YOU'RE DESTINED TO USE, AND THE BATTLE YOU'RE DESTINED TO WIN. LIKE TARRANT SAID, "VICTORY IS YOURS, IF YOU HAVE THE WILL FOR IT." HAVE NO DOUBT - YOU GOT THIS!

AND LIKE SAINT EARNEST SAID, "YOUR SACRIFICE WILL BE REMEMBERED. ALWAYS." THAT'S OUR COMMITMENT TO YOU. WE LOVE YOU, WE THANK YOU, WE SALUTE YOU, WE WILL NEVER FORGET YOU.

FUCKING HAIL, BROTHER!!!

**WITH LOVE, RESPECT
AND DOUBLE ROMANS,
TERRORGRAM**

THE HARD RESET
AUTHOR : JULIET
PAGE : 2 4 7



optics



The day is coming where your face is gonna be on the news in the form of a mugshot or an obituary.

If you're still fat or greasy then that's gonna be a huge problem.

I often look at myself in the mirror, thinking "if the pigs came knocking right now, how would my photo look on CNN? How would it look on my very own wikipedia article? On my Saint Card?"

There's no need for our guys to look like they held up a liquor store and got shot on the way out.

*Don't
look like
Nicholas Cruz.*

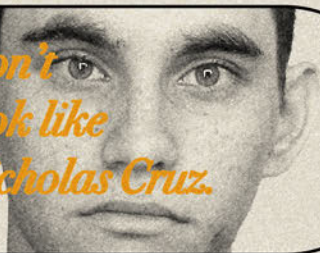

*Look
like
Philip Manshaus.*



CONSIDERATIONS OF OUR STRUGGLE



THERE ARE SEVERAL RISKS

1. **loss of job** - the system attacks your ability to feed your family
2. **financial shutdown** - the system seizes what you've worked for to date
3. **property confiscation** - the system takes your home out from around you
4. **harassment** - the system shows up where you never want it to be, everywhere
5. **arrest** - the system chains you down in it's dungeon, where you can do no damage

HOW DO YOU ELIMINATE RISKS?

1. **raw power** - be such a powerful movement that firing you would be a threat to the system itself, or cause such a commotion that firing you hurts itself more than you.
2. **economics** - the movement has the money to simply hire you for the same pay you used to get anyway, allowing you to work full time for the means of the struggle.
3. **accelerationism** - push things to the point where no one has a job anyway; there's no point in a job anymore so why not just join the movement?

1. **raw power** - the movement becomes a direct threat to banks that shut down people's accounts, the banks come to fear repercussion for it's actions against the movement
2. **economics** - the movement has such large money reserves that the movement can act as a bank for those in need; the movement sustains itself and it's people
3. **accelerationism** - the movement crashes things to the point to where the banks don't work anyway, and no one is able to use banking services reliably

1. **raw power** - the movement could easily harm/counter attack anyone attempting to seize property, cut utilities, or hurt the residents of the property
2. **economics** - the movement can simply buy back confiscated property, or alternatively buy more secure replacement property easily; commune living begins
3. **accelerationism** - the state has become so hostile that most average citizens will have their property confiscated regardless of whether they belong to the movement

1. **raw power** - the movement makes harassing movement participants essentially a death sentence for those partaking in harassment, the movement creates a culture of terror and repercussion for those involved in harassing the movement
2. **economics** - the movement can easily hire private investigators and/or security where needed in order to remove harassers, or sue them in court through lawfare and frivolous lawsuits; the movement creates financial repercussions for it's enemies
3. **accelerationism** - the movement accelerates things to the point where those who would normally harass are too busy with the breakdown of society to be able to

hardreset0000000249



nostalgia for
futures lost
long ago

bravo



JOB LOSS



FINANCIALS



PROPERTY



HARASSMENT



ARREST

1. **raw power** - the movement makes it impossible to find, or arrest movement members for fear of violent repercussion against the arresting bodies
2. **economics** - the movement becomes so economically successful that it can easily bail out all of its members at once, and afford 5-star lawyers to get all charges removed
3. **accelerationism** - violent crime becomes so rampant and common that it's impossible for the enforcement agencies to operate properly to make arrests



Once a movement has gained enough money or power to protect its members from risks, or society has broken down to the point where there is no risk of participating, then the average person will be likely to join the cause, regardless of how radical or fanatical it may be.

hardreset0000000250



legality is for
those playing
their game

bravo

AN UNCOMMON AESTHETIC

"Terrorwave existing forever so long as there is the will of terror within a vessel".

fashWAVE, terrorWAVE, call it what you like.

Take any aesthetic, fad, style, make it yours. The communists have done this for decades, coopting popular rebellious culture in order to eternally keep them in the place of the cool rebel with true cause, the resistance, the guerrilla, etc. There's no reason why we shouldn't begin claiming aesthetics ourselves.



A NOTE TO THE PROSPECTIVE LEADERS

OF TOMORROW

MAIN CONSIDERATIONS

- ▶ IF YOU'RE NOT FIT your gym rats will question you and your leadership
- ▶ IF YOU'RE NOT A GOOD SHOOTER your tactical men will question you and your leadership
- ▶ IF YOU'RE NOT WELL READ your scholars will question you and your leadership
- ▶ IF YOU'RE NOT WELL EQUIPPED your survivalists will question you and your leadership
- ▶ IF YOU'RE NOT OLD ENOUGH your old timers will question you and your leadership

HOTEL

THE HARD RESET

PAGE 252



Can you be everything? Certainly not. A leader is proficient in leading, and has at least a basic skill and understanding of everything required. A leader would certainly not delegate people out to do things that he himself is not at least somewhat capable of; but he would also not make uneducated decisions without first consulting his best guy for that job.

The best organizations are leaderless but realistic. The right way to do things is by merit.

When you and your guys are in the gym, the most fit and knowledgeable man on the topic takes over and teaches the rest. The same procedure would be replicated on the range, on the mats (martial arts), in the woods, and with books.

If one of your guys knows everything about communications, you wouldn't put him down when you needed him most, so why put him down when it comes time to for everyone to learn and train.

Everyone should bring something to the table.

Lean on your comrades, lead them in the right direction.

HARD



THEIR

TRANSFORMERICA - TRANSFORM IT IN TO A PARKING LOT SOON TO BE OVERTAKEN BY THE WEEDS AND INSECTS OF NATURE

PERCENT READY
253

LATE

TRANSFORMERICA - TRANSFORM EVERY GAY BAR IN TO A HEAPING FERTILIZER PILE FROM WHICH A NEW ECOSYSTEM CAN GROW

PERCENT MOTIVATED
253

GAME

TRANSFORMERICA - TRANSFORM THEIR TOWERS OF FALSEHOOD IN TO RUBBLE, WRITHING WITH "LOWLY" INSECT

PERCENT PLANNED
253

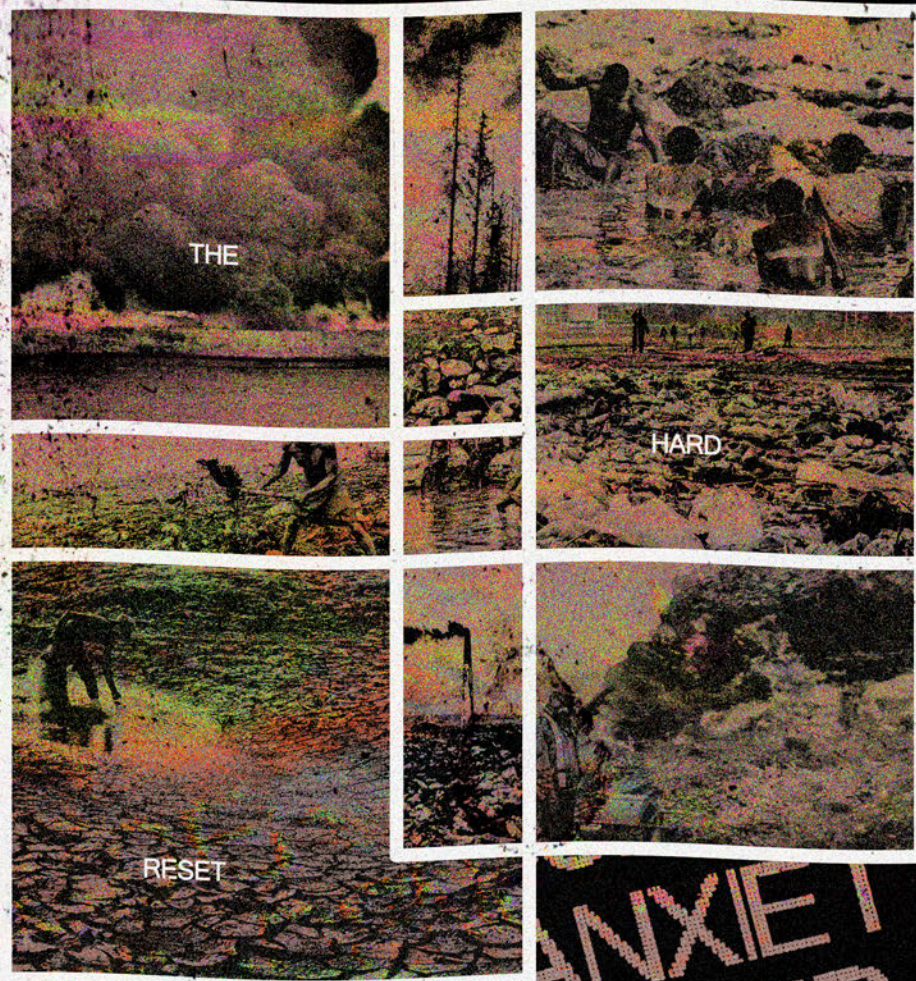

MODERNITY
DEPENDENCY

< Every town in the U.S. > - a bleak landscape of utilitarian corporate "architecture". Purely made for profit-seeking at the expense of beauty; all so they can sell you cancerous shit food that'll ruin your gut and 'planned obsolescence' Chinese "slave" labor products.



This is what a society whose highest value is money looks like; garish aesthetically disparate signs meant to sell garbage to the lowest common denominator, a disrespect of natural landscape elements in favor of hideous brutalist concrete boxes, and no consideration for cohesive beauty whatsoever. No wonder why the U.S. has such a high opiate use rate among the White population. People have to anesthetize themselves from how ugly and spiritually empty their world is.



ANXIETY
FEAR

A FINAL DECLARATION MMXXII

YOU COMPLETE YOUR JOURNEY WITH A FINAL REVELATION
"INACTION WAS THE CHOICE OF EVERY DYING VICTIM"

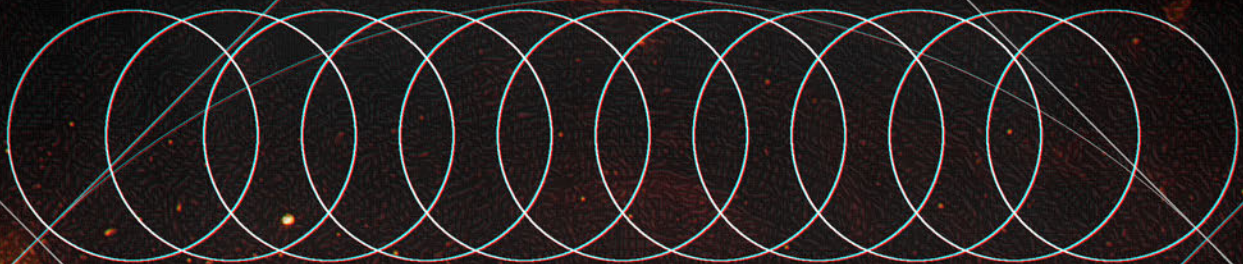

DECLARATION MMXXII INFORMATION

CHARLIE - 1 PASSAGE
NOVEMBER - 1 PASSAGE
XXXXX - 2 PASSAGES
TOTAL - 4 PASSAGES
5 PAGES

TOTAL BOOK INFORMATION

ALPHA - 1 PASSAGE
BRAVO - 3 PASSAGES
CHARLIE - 1 PASSAGE
DELTA - 1 PASSAGE
ECHO - 1 PASSAGE
FOXTROT - 1 PASSAGE
GOLF - 25 PASSAGES
HOTEL - 22 PASSAGES
INDIA - 1 PASSAGE
JULIET - 2 PASSAGES
KILO - 5 PASSAGES
LIMA - 1 PASSAGE
MIKE - 5 PASSAGES
NOVEMBER - 4 PASSAGES
OSCAR - 56 PASSAGES
PAPA - 2 PASSAGES
QUEBEC - 3 PASSAGES
ROMEO - 2 PASSAGES
SIERRA - 1 PASSAGE
TANGO - 3 PASSAGES
UNIFORM - 3 PASSAGES
VICTOR - 1 PASSAGE
WHISKEY - 13 PASSAGES
X-RAY - 1 PASSAGE
YANKEE - 8 PASSAGES
ZULU - 8 PASSAGES
XXXXX - 8 PASSAGES
TOTAL - 182 PASSAGES
258 PAGES

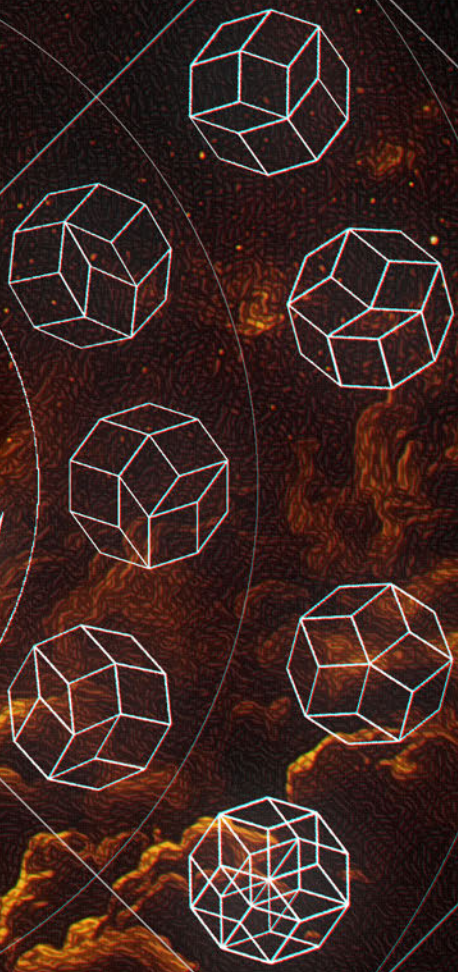

254-258
HARD RESET

254

XXX XXX XXX XXX XXX XXX

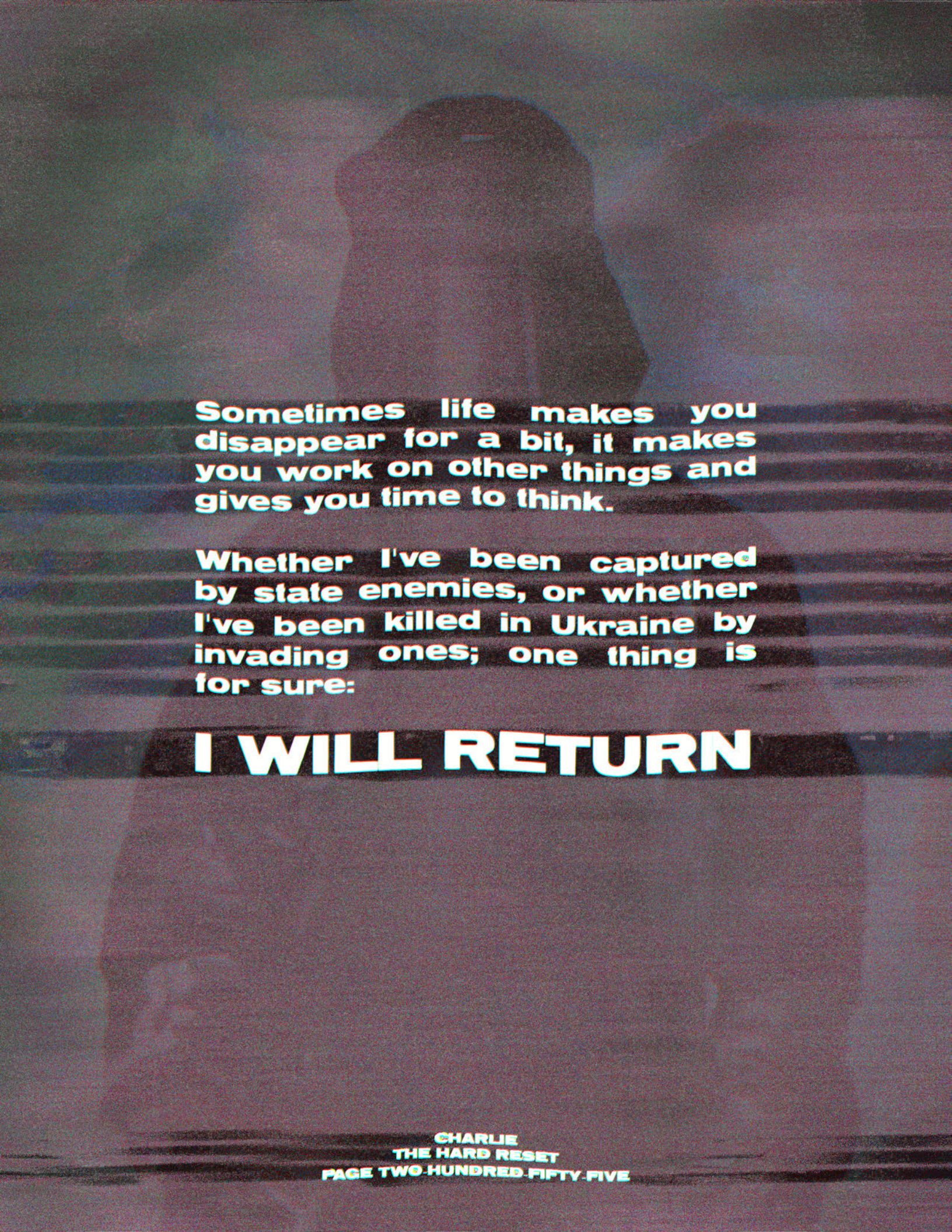

Sometimes life makes you disappear for a bit, it makes you work on other things and gives you time to think.

Whether I've been captured by state enemies, or whether I've been killed in Ukraine by invading ones; one thing is for sure:

I WILL RETURN

TERRORGRAM

WHAT IS TO COME

FOLLOWING THE HARD RESET 2022



SAINT ENCYCLOPEDIA



THE LIST



FRAMEWORK FOR VICTORY



XXXXX





XXXXX